

SPLIT-TYPE AIR CONDITIONERS

Wrap Yourself in Comfort and Quiet
Eco-conscious Technologies from Japan

Air Conditioner Catalogue
2023



Environmental Sustainability Vision 2050

Environmental Declaration

Protect the air, land, and water with our hearts and technologies to sustain a better future for all.



Environmental Sustainability Vision 2050

To solve various factors that lead to environment issues, the Mitsubishi Electric Group shall unite the wishes of each and every person, and strive to create new value for a sustainable future.

Three Environmental Action Guidelines

1

Apply diverse technologies in wide-ranging business areas to solve environmental issues

2

Challenge to develop business innovations for future generations

3

Publicize and share new values and lifestyles

Key Initiatives

- Climate Change Measures
- Resource Circulation
- Live in Harmony with Nature
- Long-term Activities
- Innovation
- Nurturing Human Resources
- Understanding Needs
- Co-create and Disseminate New Values
- Live in Harmony with the Region

Heat pump technology inspires Mitsubishi Electric to design air conditioners that harmonize comfort and ecology.

Heat Pump Principle (When Heating)
<Case of COP 5.0>

Refrigerant and Heat Circulation

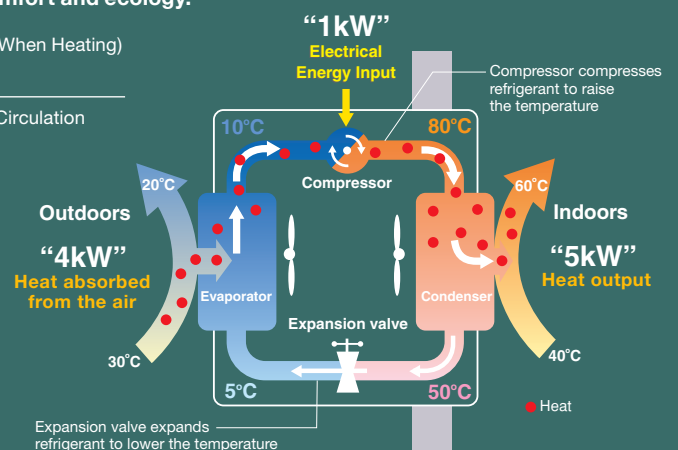



Mitsubishi Electric takes on the challenge of creating new value and contribute to a sustainable future in order to solve various environmental problems.

Preventing Global Warming

Mitsubishi Electric is actively introducing R32 refrigerant which has a global warming potential approximately 1/3 that of R410A refrigerant. Not only by shifting from R410A to R32 but by decreasing the diameter of refrigerant piping, we are also striving to reduce the amount of refrigerant usage. Through these activities, we have achieved significant reduction in CO₂ equivalent amount compared to conventional models and realised minimizing the negative impact to the environment more than ever.

Reducing the amount of refrigerant usage

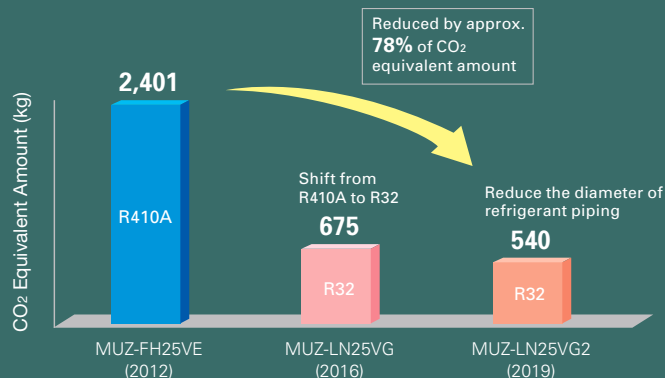

* reduction rate differs model by model.

Effective use of materials (Reduce & Recycle)

1. Accelerating the downsizing technology to reduce material use while balancing energy saving performance.
2. Designing products that are easy to separate and recycle.
3. All models are designed for WEEE and RoHS (II) compliance.*

*WEEE and RoHS directive: The Waste Electrical and Electronic Equipment (WEEE) Directive is a recycling directive for this type of equipment, while the Restrictions of Hazardous Substances (RoHS) Directive is an EU directive restricting the use of ten specified substances in electronic and electrical devices. In the EU, it is no longer possible (from July 2019) to sell products containing any of the ten substances.

Balancing comfort and ecology

Mitsubishi Electric develops technologies to balance comfort and ecology, achieving greater efficiency in heat pump operation.

	Comfort	Ecology
1. Inverter	Faster start-up and more stable indoor temperature than non-inverter units.	Fewer On/Off operations than with non-inverter, saving energy.
2. 3D i-see Sensor	Since the positions of people can be detected, airflow can be set to personal taste, such as in airflow path or protected from the wind. The ability to adjust to individual preferences realizes more comfortable air conditioning.	Since the number of people in a room can be detected, energy-saving operation is adjusted or the power is turned off automatically. Efficient air conditioning with less waste is realized.
3. Flash Injection	Achieves high heating capacity even at low temperatures, plus faster start-up compared to conventional inverters.	Expands heat pump heating system to the cold regions to replace combustion heaters.
4. Dual Barrier Coating Dual Barrier Material	Prevents the indoor unit from getting dirty, delivering you clean air.	Keeping the inside of air conditioner clean leads to efficient operation and energy saving.

C

CONTENTS



Air Conditioners

New releases in 2023	005-006
LINE-UP	007-010
M SERIES	011-055
S SERIES	057-072
P SERIES	073-119
MULTI SPLIT SERIES	121-137
POWERFUL HEATING SERIES	139-160

Air Conditioners

NEW ECODESIGN DIRECTIVE	161-162
INVERTER TECHNOLOGIES	163-164
COMFORT	165-169
AIR QUALITY	171-176
CONVENIENCE	177-178
INSTALLATION & MAINTENANCE	179-180
SYSTEM CONTROL	181-182
CONTROL TECHNOLOGIES	183-190
SYSTEM CONTROL	191-192
FUNCTION LIST	193-200
OPTIONAL PARTS	201-212
EXTERNAL DIMENSIONS	213-232
PIPING INSTALLATION	233-242

M/S/P/Multi/Zubadan/ATW

CONDITIONS FOR SPECIFICATIONS	243
REFRIGERANT AMOUNT	244
R32 REFRIGERANT	245-246

LOSSNAY SYSTEM

FEATURES & SPECIFICATIONS	247-288
--	----------------

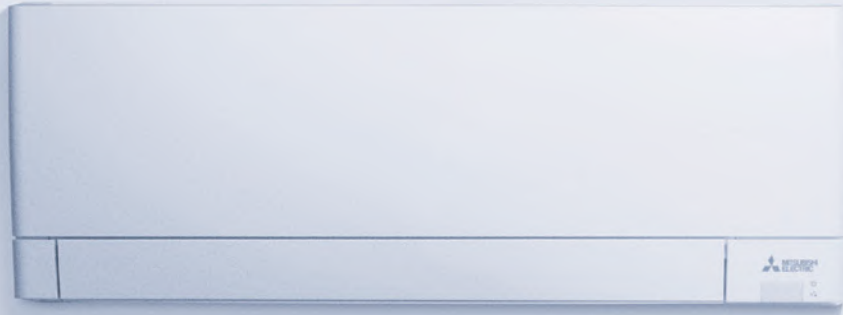

AY Series

Elegant and Sophisticated Matt



New releases in 2023

M SERIES

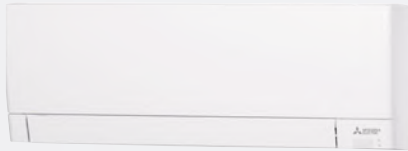

R32
MSZ-AY25/35/42/50VGK(P)
P.19

S SERIES



R32
SFZ-M
P.70



R32
MLZ-KY20VG
P.49

LOSSNAY SERIES



LGH-15/25/35/50/65/80/
100/160/200RVX3-E
P.252

LINE-UP

M SERIES INVERTER Models

Model Name		1.5kW	1.8kW	2.0kW	2.2kW	2.5kW	3.5kW	4.2kW	5.0kW	6.0kW	7.1kW	Page	
		1-phase	1-phase	1-phase	1-phase	1-phase	1-phase	1-phase	1-phase	1-phase	1-phase		
Wall-mounted	MSZ-L Series R32 R410A *2 		WVRB Multi connection only			WVRB SINGLE	WVRB SINGLE		WVRB SINGLE	WVRB SINGLE		13	
	MSZ-AY series R32 R410A *3 					SINGLE H	SINGLE H	SINGLE H	SINGLE H			19	
	MSZ-AP series R32 R410A *1  MSZ-AP60/71VG(K) MSZ-AP15/20VG(K)	SINGLE		SINGLE							SINGLE	SINGLE	23
	MSZ-E Series R32 R410A *1 		WSB Multi connection only		WSB Multi connection only	WSB SINGLE H	WSB SINGLE H	WSB SINGLE	WSB SINGLE				29
	MSZ-BT Series R32 			SINGLE		SINGLE	SINGLE		SINGLE				31
	MSZ-HR Series R32  MSZ-HR25/35/42/50VF(K) MSZ-HR60/71VF(K)					SINGLE	SINGLE	SINGLE	SINGLE	SINGLE	SINGLE	SINGLE	33
	MSZ-DW Series R32 					SINGLE	SINGLE		SINGLE				35
	MSY-TP Series R32 						SINGLE		SINGLE				37
	MSZ-S Series R410A  MSZ-SF15/20VA MSZ-SF25/35/42/50VE3	Multi connection only		Multi connection only			SINGLE H	SINGLE H	SINGLE H	SINGLE H			39
	MSZ-G Series R410A 										SINGLE	SINGLE	39
	MSZ-D Series R410A 					SINGLE	SINGLE						43
	MSZ-H Series R410A  MSZ-HJ25/35/50 MSZ-HJ60/71					SINGLE	SINGLE		SINGLE	SINGLE	SINGLE		45
Compact floor MFZ Series R32 					SINGLE	SINGLE		SINGLE	SINGLE			47	
1-way cassette MLZ Series R32  MLZ-KP25/35/50VF MLZ-KY20VG			Multi connection only		SINGLE	SINGLE		SINGLE				49	

*1: R410A is for MXZ and PUMY connection.
*2: R410A is for PUMY connection.



H : Outdoor unit with freeze-prevention heater is available.
W-S-B: Indoor units are available in three colours; White, Black and Silver.
W-V-R-B: Indoor units are available in four colours; Natural White, Pearl White, Ruby Red, and Onyx Black.

Indoor Combinations

- SINGLE** 1 outdoor unit & 1 indoor unit
- TWIN** 1 outdoor unit & 2 indoor units
- TRIPLE** 1 outdoor unit & 3 indoor units
- QUADRUPLE** 1 outdoor unit & 4 indoor units

S SERIES

INVERTER Models

Model Name		1.5kW	2.5kW	3.5kW	5.0kW	6.0kW	7.1kW	10.0kW	12.5kW	14.0kW	Page
		1-phase	1-phase	1-phase	1-phase	1-phase	1-phase	1- & 3-phase	1- & 3-phase	1- & 3-phase	
2 x 2 cassette	SLZ Series R32 R410A 	Multi connection only	SINGLE	SINGLE	SINGLE	SINGLE	TWIN	TWIN TRIPLE	TWIN TRIPLE QUADRUPLE	TRIPLE QUADRUPLE	59
Compact ceiling-concealed	SEZ Series R32 R410A 		SINGLE *	SINGLE *	SINGLE *	SINGLE *	SINGLE TWIN	TWIN TRIPLE	TWIN TRIPLE QUADRUPLE	TRIPLE QUADRUPLE	65
Concealed floor standing	SFZ Series R32 		SINGLE	SINGLE	SINGLE	SINGLE					70

* Indoor units are available in two types; with or without the wireless remote controller.

P SERIES

R32 Power Inverter Models / R32 Standard Inverter Models

Model Name		3.5kW	5.0kW	6.0kW	7.1kW	10.0kW	12.5kW	14.0kW	20.0kW	25.0kW	Page
		1-phase	1-phase	1-phase	1-phase	1- & 3-phase	1- & 3-phase	1- & 3-phase	3-phase	3-phase	
4-way cassette	PLA Series R32 	SINGLE	SINGLE	SINGLE	SINGLE TWIN *	SINGLE TWIN	SINGLE TWIN	SINGLE TWIN TRIPLE	TWIN TRIPLE QUADRUPLE	TWIN TRIPLE QUADRUPLE	84
Ceiling-concealed	PEAD Series R32 	SINGLE	SINGLE	SINGLE	SINGLE TWIN *	SINGLE TWIN	SINGLE TWIN	SINGLE TWIN TRIPLE	TWIN TRIPLE QUADRUPLE	TWIN TRIPLE QUADRUPLE	94
	PEA Series R32 								SINGLE	SINGLE	99
Wall-mounted	PKA Series R32 	SINGLE *	SINGLE *	SINGLE *	SINGLE TWIN *	SINGLE TWIN	TWIN	TWIN TRIPLE	TWIN TRIPLE QUADRUPLE	TRIPLE QUADRUPLE	102
Ceiling-suspended	PCA-KA Series R32 	SINGLE	SINGLE	SINGLE	SINGLE TWIN *	SINGLE TWIN	SINGLE TWIN TRIPLE	TWIN TRIPLE QUADRUPLE	TWIN TRIPLE QUADRUPLE	TRIPLE QUADRUPLE	107
for Professional Kitchen	PCA-HA Series* R32 				SINGLE *			TWIN *		TRIPLE *	112
Floor-standing	PSA Series R32 				SINGLE *	SINGLE	SINGLE	SINGLE TWIN	TWIN	TWIN TRIPLE	115

R410A POWER INVERTER Models / R410A STANDARD INVERTER Models







* R32 Power Inverter Model only

Model Name		3.5kW	5.0kW	6.0kW	7.1kW	10.0kW	12.5kW	14.0kW	20.0kW	25.0kW	Page
		1-phase	1-phase	1-phase	1-phase	1- & 3-phase	1- & 3-phase	1- & 3-phase	3-phase	3-phase	
4-way cassette	PLA Series R410A 	SINGLE	SINGLE	SINGLE	SINGLE TWIN *	SINGLE TWIN	SINGLE TWIN	SINGLE TWIN TRIPLE	TWIN TRIPLE QUADRUPLE	TWIN TRIPLE QUADRUPLE	84
Ceiling-concealed	PEAD Series R410A 	SINGLE	SINGLE	SINGLE	SINGLE TWIN *	SINGLE TWIN	SINGLE TWIN	SINGLE TWIN TRIPLE	TWIN TRIPLE QUADRUPLE	TWIN TRIPLE QUADRUPLE	94
	PEA Series R410A 								SINGLE	SINGLE	99
Wall-mounted	PKA Series R410A 	SINGLE *	SINGLE *	SINGLE *	SINGLE TWIN *	SINGLE TWIN	TWIN	TWIN TRIPLE	TWIN TRIPLE QUADRUPLE	TRIPLE QUADRUPLE	102
Ceiling-suspended	PCA-KA Series R410A 	SINGLE	SINGLE	SINGLE	SINGLE TWIN *	SINGLE TWIN	SINGLE TWIN TRIPLE	TWIN TRIPLE QUADRUPLE	TWIN TRIPLE QUADRUPLE	TRIPLE QUADRUPLE	107
for Professional Kitchen	PCA-HA Series* R410A 				SINGLE *			TWIN *		TRIPLE *	112
Floor-standing	PSA Series R410A 				SINGLE *	SINGLE	SINGLE	SINGLE TWIN	TWIN	TWIN TRIPLE	115

* Power Inverter Models only



LINE-UP

MXZ SERIES INVERTER Models









Model Name	Capacity Class	Page
up to 2 indoor units MXZ-2F33VF4 R32	3.3kW <1-phase>	123
up to 2 indoor units MXZ-2F42VF4 R32 	4.2kW <1-phase>	123
up to 2 indoor units MXZ-2F53VF(H)4 R32	5.3kW <1-phase>	123
up to 3 indoor units MXZ-3F54VF4 R32	5.4kW <1-phase>	123
up to 3 indoor units MXZ-3F68VF4 R32 	6.8kW <1-phase>	123
up to 4 indoor units MXZ-4F72VF3 R32	7.2kW <1-phase>	123
up to 4 indoor units MXZ-4F80VF4 R32	8.0kW <1-phase>	123
up to 4 indoor units MXZ-4F83VF2 R32 	8.3kW <1-phase>	123
up to 5 indoor units MXZ-5F102VF2 R32	10.2kW <1-phase>	123
up to 6 indoor units MXZ-6F120VF2 R32 	12.0kW <1-phase>	123
up to 2 indoor units MXZ-2HA40VF2 R32 	4.0kW <1-phase>	127
up to 2 indoor units MXZ-2HA50VF2 R32	5.0kW <1-phase>	127
up to 3 indoor units MXZ-3HA50VF2 R32 	5.0kW <1-phase>	127

Model Name	Capacity Class	Page
up to 2 indoor units MXZ-2D33VA R410A	3.3kW <1-phase>	125
up to 2 indoor units MXZ-2D42VA2 R410A 	4.2kW <1-phase>	125
up to 2 indoor units MXZ-2D53VA (H)2 R410A	5.3kW <1-phase>	125
up to 3 indoor units MXZ-3E54VA R410A	5.4kW <1-phase>	125
up to 3 indoor units MXZ-3E68VA R410A 	6.8kW <1-phase>	125
up to 4 indoor units MXZ-4E72VA R410A	7.2kW <1-phase>	125
up to 4 indoor units MXZ-4E83VA R410A 	8.3kW <1-phase>	125
up to 5 indoor units MXZ-5E102VA R410A	10.2kW <1-phase>	125
up to 6 indoor units MXZ-6D122VA2 R410A 	12.2kW <1-phase>	125

PUMY SERIES INVERTER Models

Model Name	12.5kW	14.0kW	15.5kW	22.4kW	28.0kW	33.5kW	Page
	1 & 3-phase	1 & 3-phase	1 & 3-phase	3-phase	3-phase	3-phase	
PUMY-SP R410A 	✓	✓	✓				129
PUMY-P R410A 	✓	✓	✓	✓	✓	✓	131

POWERFUL HEATING SERIES INVERTER Models

Model Name		2.5kW	3.5kW	5.0kW	5.3kW	6.0kW	8.3kW	10.0kW	12.5kW	Page
		1-phase	1-phase	1-phase	1-phase	1-phase	1-phase	1 & 3-phase	3-phase	
Wall-mounted	MSZ-RW VGHZ Series R32 R410A 	SINGLE _H	SINGLE _H	SINGLE _H						141
	MSZ-LN VGHZ Series R32 R410A 	SINGLE _H	SINGLE _H	SINGLE _H						145
	MSZ-FT VGHZ Series R32 	SINGLE _H	SINGLE _H	SINGLE _H						147
Compact floor	MFZ-KW Series R32 	SINGLE _H	SINGLE _H	SINGLE _H		SINGLE _H				149
ZUBADAN	4-way cassette R32 R410A 							SINGLE TWIN	SINGLE TWIN	152
	Ceiling-concealed R32 R410A 							SINGLE TWIN		154
	Wall-mounted R32 R410A 							SINGLE TWIN		155
Multi split	MXZ-FVFHZ2 Series MXZ-EVAHZ Series R32 R410A  				2PORT _H		4PORT _H			156







* R410A is for PUMY connection.

H: Freeze-prevention heater is included as standard equipment.

Indoor Combinations

- SINGLE** 1 outdoor unit & 1 indoor unit
- TWIN** 1 outdoor unit & 2 indoor units
- TRIPLE** 1 outdoor unit & 3 indoor units
- QUADRUPLE** 1 outdoor unit & 4 indoor units

LOSSNAY SERIES

Centralized Ventilation				Decentralized Ventilation	
Ceiling Concealed Type				Vertical Type	Wall Mounted Type
					 
LGH-RVX3 Series	LGH-RVXT Series	LGH-RVS	GUF Series	VL-CZPVU Series	VL-100(E)U _s -E VL-50(E)S ₂ -E VL-50SR ₂ -E











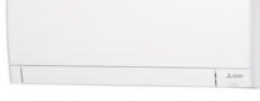
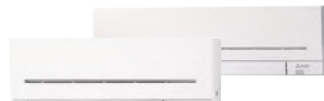

M

SERIES



SELECTION

Choose the model that best matches room conditions.

SELECT SERIES		
A multiple series line-up to choose from, each with various outstanding features. In addition to inverter-equipped models, constant-speed, floor-standing and cassette models can be selected. Choose the best series to match usage needs.		
Wall-mounted Units		
MSZ-L SERIES R32 R410A *2  25/35/50/25/35 25/35 SEER A+++ SCOP A+++ MXZ connection	MSZ-AY SERIES R32 R410A *2  25/35 25-50 SEER A+++ SCOP A+++ MXZ connection	MSZ-AP SERIES R32 R410A *1 MSZ-AP60/71VG(K)  MSZ-AP15/20VG(K) 20 60 SEER A+++ SCOP A+++ MXZ connection
MSZ-E SERIES R32 R410A *1  25/35 25/35 SEER A+++ SCOP A+++ MXZ connection	MSZ-BT SERIES R32  25/35 SEER A+++ SCOP A+++ MXZ connection	MSZ-HR SERIES R32 MSZ-HR60/71VF(K)  MSZ-HR25-50VF(K) SEER A+++ SCOP A+++ MXZ connection
MSZ-DW SERIES R32  SEER A+++ SCOP A+++ MXZ connection	MSY-TP SERIES R32  35 SEER A+++	MSZ-S SERIES R410A MSZ-SF25-50VE  MSZ-SF15/20VA SEER A+++ SCOP A+++ MXZ connection
MSZ-G SERIES R410A  SEER A+++ SCOP A+++ MXZ connection	MSZ-DM SERIES R410A  SEER A+++ SCOP A+++ MXZ connection	MSZ-HJ SERIES R410A MSZ-HJ60/71  MSZ-HJ25/35/50 50/60/71 50/60/71 SEER A SCOP A MXZ connection
Floor-standing		Cassette Units
MFZ SERIES R32  SEER A+++ SCOP A+++ MXZ connection	MLZ SERIES R32  MXZ connection MLZ-KP25/35/50VF MLZ-KY20VG	



SEER A SCOP A Energy Rank

R32 R32 Refrigerant

MXZ connection Compatible for connection to MXZ Series system

R410A R410A Refrigerant

*1 R410A is for MXZ and PUMY connection.
*2 R410A is for PUMY connection.

SELECT OUTDOOR UNIT		
Some outdoor units in the line-up have heaters for use in cold regions. Units with an "H" in the model name are equipped with heaters.		
Heater Installed MUZ-AY25/35/42/50VGH MUZ-EF25/35VGH MUZ-SF25/35/42/50VEH	Hyper Heating MUZ-RW25/35/50VGHZ MUZ-LN25/35/50VGHZ MUZ-FT25/35/50VGHZ MUZ-FH25/35/50VEHZ MUZ-KW25/35/50/60VGHZ	Selecting a Heater-equipped Model In regions with the following conditions, there is a possibility that water resulting from condensation on the outdoor unit when operating in the heating mode will freeze and not drain from the base. 1) Cold outdoor temperatures (temperature does not rise above 0°C all day) 2) Areas where dew forms easily (in the mountains, valleys (surrounded by mountains), near a forest, near unfrozen lakes, ponds, rivers or hot springs), or areas with snowfall. To prevent water from freezing in the base, it is recommended that a unit with a built-in heater be purchased. Please ask your dealer representative about the best model for you.
 MUZ-LN25/35VG	 MUZ-LN50VG2	

MSZ-L SERIES

R32
Single / MXZ, PUMY

R410A
PUMY

MSZ-LN18/25/35/50/60VG2

GOOD DESIGN AWARD 2016
BEST 100



Developed to complement modern interior room décor, the LN Series is available in four colours specially chosen to blend in naturally wherever installed. Not only the sophisticated design, but also the optimum energy efficiency and operational comfort add even more value to this series.

Luminous and Luxurious Design

Natural White, Pearl White, Ruby Red, and Onyx Black. LN Series indoor units are available in four colours to match various lifestyles. The appearance of the indoor unit differs depending on the lighting in the room, attracting the attention of everyone that enters the room.



Master craftsmanship painting technology has resulted in a refined design, giving the finish deep colour and a premium quality feel.



Pearl White blends in with any interior.



Ruby Red gives an accent to the room, affording timeless elegance to sophisticated interiors.

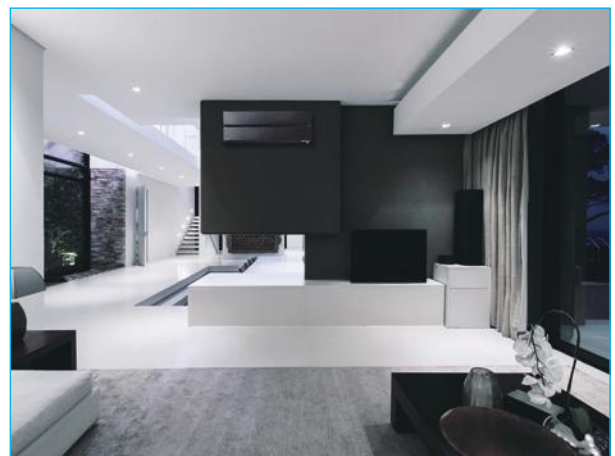

Onyx Black matches darker interiors, creating a comfortable environment.

LED Backlight Remote Controller

Not only the indoor units, but the wireless remote controllers come in four colours as well. Each remote controller matches the indoor unit. Even the textures are the same.

The setting can be easily checked in the dark thanks to LED backlight.



High Energy Efficiency



Optimum cooling/heating performance is another feature for the LN series. Models from capacities 25 to 50 have achieved the "Rank A+++" for SEER, and models for capacities 25 and 35 have achieved the "Rank A+++" for SCOP as well.

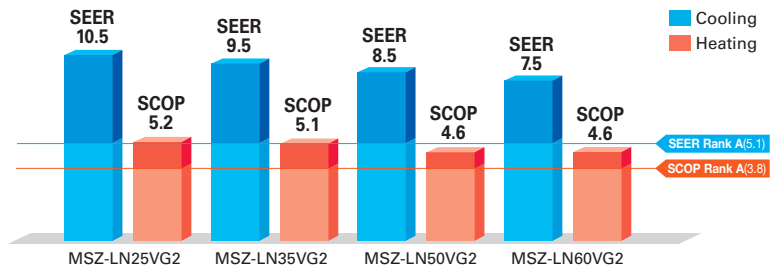

3D i-see Sensor

The LN Series is equipped with 3D i-see Sensor, an infrared-ray sensor that measures the temperature at distant positions. While moving to the left and right, eight vertically arranged sensor elements analyze the room temperature in three dimensions. This detailed analysis makes it possible to judge where people are in the room, thus allowing creation of features such as "Indirect airflow," to avoid airflow hitting people directly, and "direct airflow" to deliver airflow to where people are.

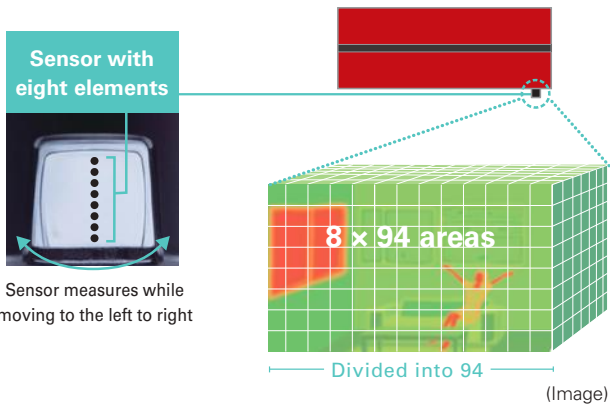

Indirect Airflow

The indirect airflow setting can be used when the flow of air feels too strong or direct. For example, it can be used during cooling to avert airflow and prevent body temperature from becoming excessively cooled.



Direct Airflow

This setting can be used to directly target airflow at people such as for immediate comfort when coming indoors on a hot (cold) day.

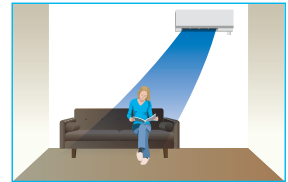

Even Airflow *LN Series only

Normal swing mode

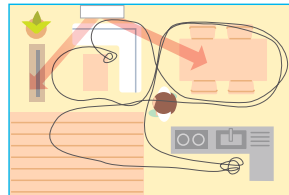

Even airflow mode

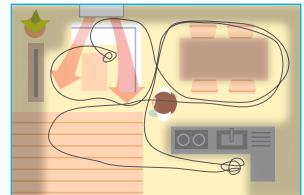

The airflow is distributed equally throughout the room, even to spaces where there is no human movement.

The 3D i-see sensor memorizes human movement and furniture positions, and efficiently distributes airflow.

No occupancy energy-saving mode

The sensors detect whether there are people in the room. When no-one is in the room, the unit automatically switches to energy-saving mode.

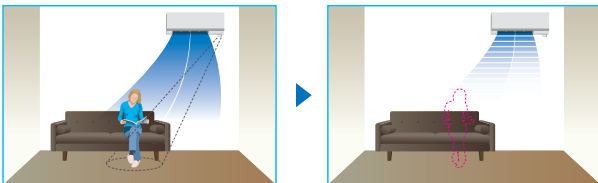

The "3D i-see Sensor" detects people's absence and the power consumption is automatically reduced approximately 10% after 10 minutes and 20% after 60 minutes.

No occupancy Auto-OFF mode *LN Series only

The sensors detect whether or not there are people in the room. When there is no one in the room, the unit turns off automatically.

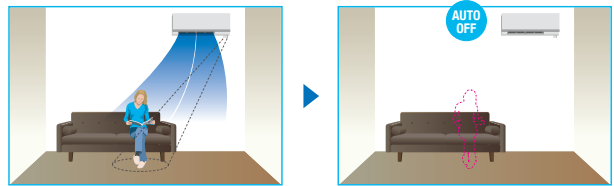

Circulator Operation

(MSZ-LN18/25/35/50/60VG-SC Scandinavian model)

In case the indoor temperature reaches the setting temperature, the outdoor unit stops and the indoor unit starts FAN operation to circulate the indoor air.

The outdoor unit starts operation automatically when the indoor temperature drops below the setting temperature.

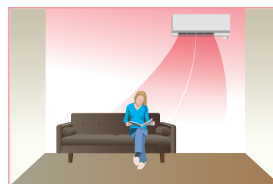

If the heating operation is continued, the warm air is formed around ceiling.

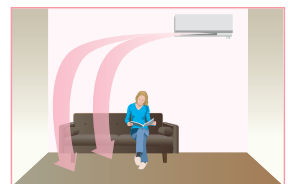

This operating can help to circulate and refresh warm air.

Plasma Quad Plus

Plasma Quad Plus is a plasma-based filter system that effectively removes six kinds of air pollutants. Plasma Quad Plus captures mold and allergens more effectively than Plasma Quad. It can also capture PM2.5 and particles smaller than 2.5µm, creating healthy living spaces for all.

Bacteria

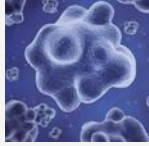

Test results have confirmed that Plasma Quad Plus neutralizes 99% of bacteria in 162 minutes in a 25m³ test space.

<Test No.> KRCEs-Bio. Test Report No. 2016-0118

Viruses

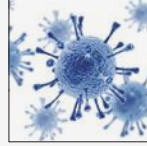

Test results have confirmed that Plasma Quad Plus neutralizes 99% of virus particles in 72 minutes in a 25m³ test space.

<Test No.> vrc.center, SMC No. 28-002

Molds



Test results have confirmed that Plasma Quad Plus neutralizes 99% of mold in 135 minutes in a 25m³ test space.

<Test No.> Japan Food Research Laboratories Test Report No. 16069353001-0201

Allergens



In a test, air containing cat fur and pollen was passed through the air cleaning device at the low airflow setting. Before and after measurements confirm that Plasma Quad Plus neutralizes 98% of cat fur and pollen.

<Test No.> ITEA Report No. T1606028

PM2.5



Test results have confirmed that Plasma Quad Plus removes 99% of PM2.5 in 145 minutes in a 28m³ test space.

<In-company investigation>

Dust



Test results have confirmed that Plasma Quad Plus removes 99.7% of dust and mites.

<Test No.> ITEA Report No. T1606028

Model	Name	Method	Bacteria	Viruses	Molds	Allergens	Dust	PM2.5*
FH Series	Plasma Quad	One-Stage Plasma	A	A	B	B	C	
LN Series	Plasma Quad Plus	Two-Stage Plasma	A	A	A	A	A	A

A: Highly effective
B: Effective
C: Partially effective

*PM2.5:
Particles smaller than 2.5µm



Image of Plasma Quad Plus

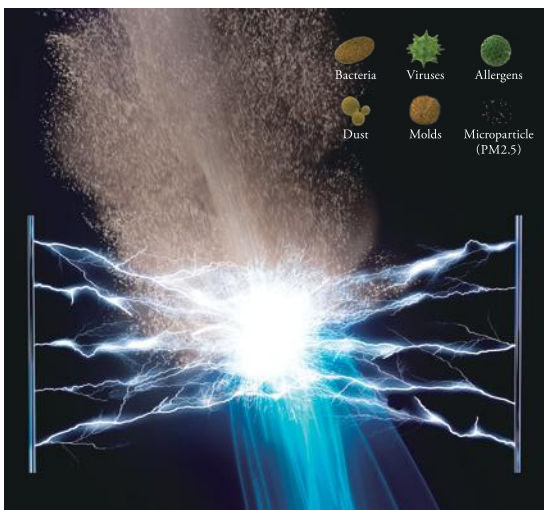

Principle of Plasma Quad Plus

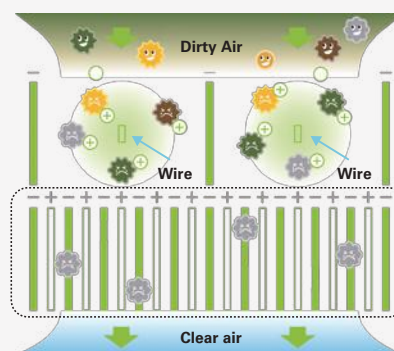

Dust, PM2.5
 Viruses Bacteria
 Mold Allergens

1st stage

- Make plasma.
- Break mold and allergens. Inhibit viruses.
- Dust and PM2.5 given an electrical charge (+).

2nd stage

- Make a strong electrical field.
- The charged dust and PM2.5 (+) are absorbed in the strong electrical field (-).



Dual Barrier Coating

A two-barrier coating prevents dust and greasy dirt from getting into the air conditioner.

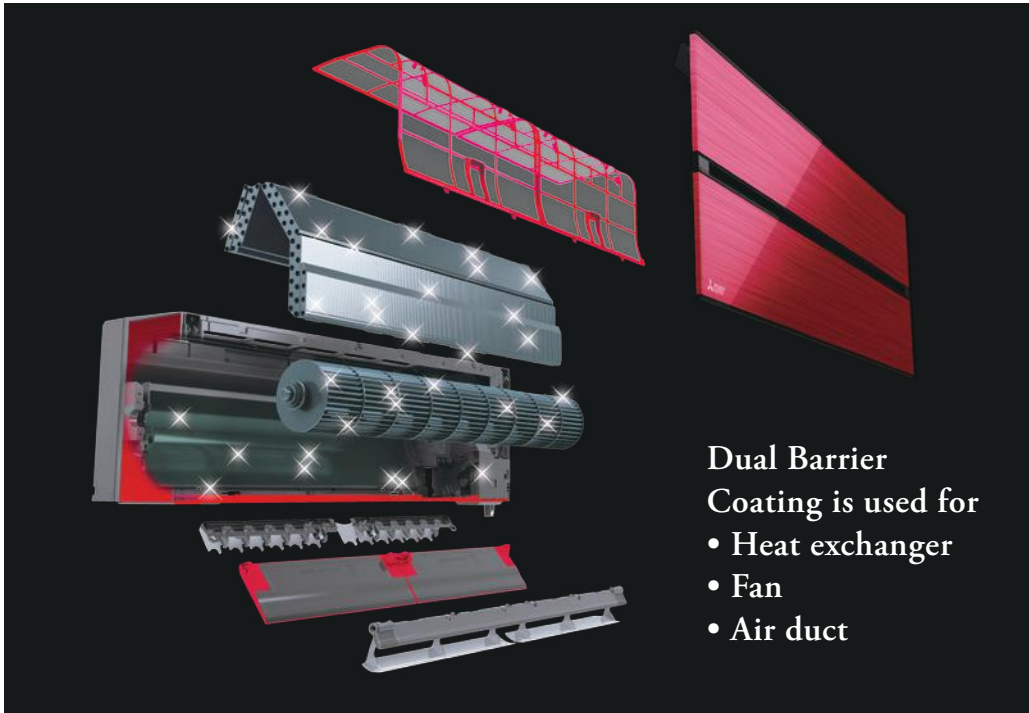

SIAA *1
Anti Fungus
 JP0512075X0001C
 (Fan, Air duct)

State-of-the-art coating technology

Dirt is generally classified into two groups: hydrophilic dirt such as fiber dust and sand dust, and hydrophobic dirt such as oil and cigarette smoke. Mitsubishi Electric's dual barrier coating works as a two-barrier coating that prevent hydrophilic dirt penetration and "hydrophilic particles" that prevent hydrophobic dirt from getting into the air conditioner. This dual coating on the inner surface keeps the air conditioner clean year-round.

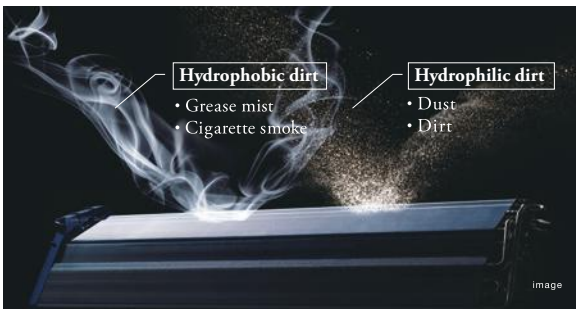

Comparison of dirt on heat exchanger, fan and air duct (in-house comparison)

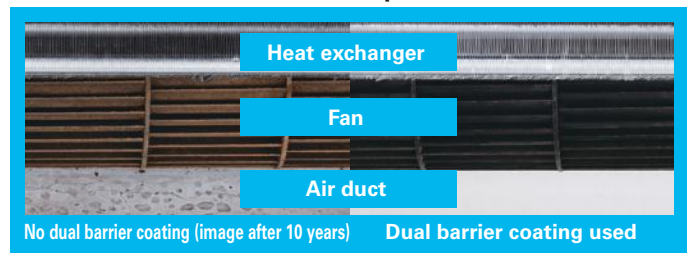

The inside of the indoor unit gets dirty after many years of usage.

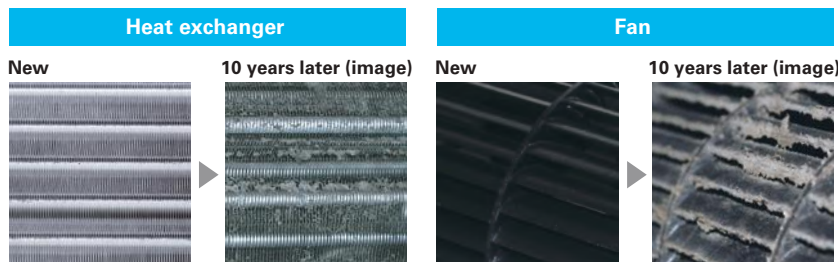

Consequences when the inside of the indoor unit is left dirty

- Deterioration in energy efficiency
- Musty smell from the unit

*1 Verified by SIAA test method (JIS Z 2911) with No. JP0501014A0002O on SIAA antifungal agent positive list. Antifungal effect depends on the working environment. Fungicides comply with the SIAA safety criteria.
 What is SIAA? https://www.kohkin.net/en_index/en_siaa.html

Double Flap

The vanes create various airflows to make each person in the room comfortable. Not only the horizontal vanes, but also the vertical vanes move independently, eliminating hot spots or cold spots throughout the room.



Night Mode

When Night Mode is activated using the wireless remote controller, air conditioner operation will switch to the following settings.

- The brightness of the operation indicator lamp will become dimmer.
- The beeping sound will be disabled.
- The outdoor operating noise will drop to 3dB lower than the rated operating noise specification.

*The cooling/heating capacity may drop.

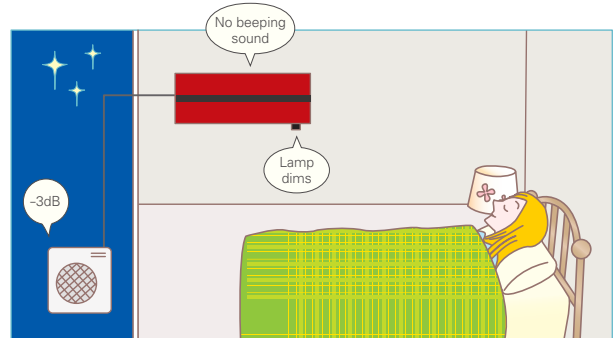

10°C Heating

During heating operation, the temperature can be set in 1°C increments down to 10°C.

This function can also be used with the Weekly Timer setting.

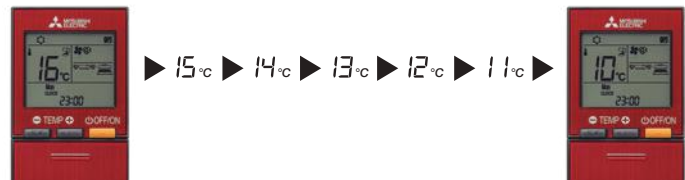

Quiet Operation

The indoor unit noise level is as low as 19dB for LN25/35 models, offering a peaceful inside environment.

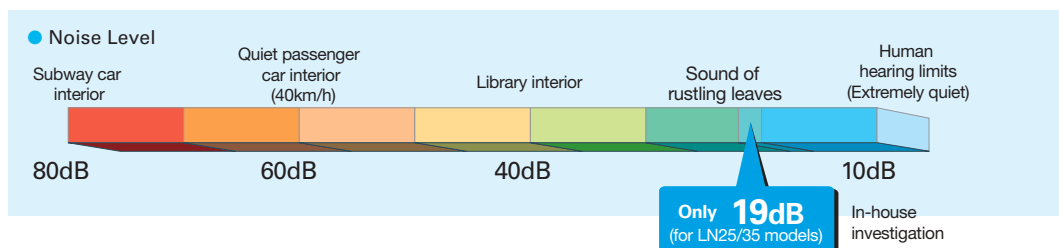

Built-in Wi-Fi Interface

The indoor unit is equipped with a Wi-Fi Interface inside an exclusive pocket in the unit.

This eliminates the need to install a Wi-Fi interface, and also contributes to the beautiful appearance since the interface is hidden.

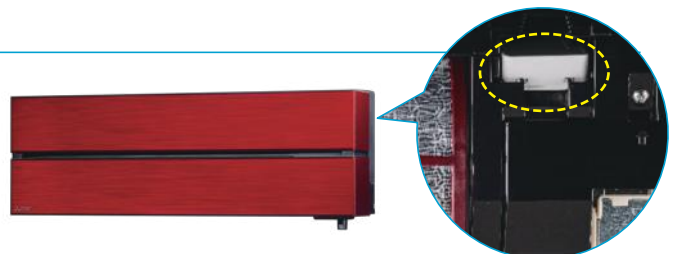

MSZ-L SERIES



Indoor Unit / Remote Controller



<Pearl White>



MSZ-LN18/25/35/50/60VG2V

<Ruby Red>



MSZ-LN18/25/35/50/60VG2R

<Natural White>



MSZ-LN18/25/35/50/60VG2W

<Onyx Black>



MSZ-LN18/25/35/50/60VG2B

Outdoor Unit



MUZ-LN25/35VG2



MUZ-LN50VG2



MUZ-LN60VG2



Type	Inverter Heat Pump							
Indoor Unit	MSZ-LN18VG2	MSZ-LN25VG2	MSZ-LN35VG2	MSZ-LN50VG2	MSZ-LN60VG2			
Outdoor Unit	for MXZ connection	MUZ-LN25VG2	MUZ-LN35VG2	MUZ-LN50VG2	MUZ-LN60VG2			
Refrigerant	Single: R32 ⁽¹⁾ / Multi: R410A or R32 ⁽¹⁾							
Power Source	Outdoor Power Supply							
Supply	Outdoor (V / Phase / Hz)							
			230 / Single / 50					
Cooling	Design load	kW	–	2.5	3.5	5.0	6.1	
	Annual electricity consumption ⁽²⁾	kWh/a	–	83	129	205	285	
	SEER ⁽⁴⁾		–	10.5	9.5	8.5	7.5	
	Capacity	Energy efficiency class		–	A+++	A+++	A+++	A++
		Rated	kW	–	2.5	3.5	5.0	6.1
Heating (Average Season) ⁽⁵⁾	Declared Capacity	kW	–	1.0 - 3.5	0.8 - 4.0	1.0 - 6.0	1.4 - 6.9	
	Back up heating capacity	Rated	kW	–	0.485	0.820	1.380	1.790
		at reference design temperature	kW	–	3.0 (-10°C)	3.6 (-10°C)	4.5 (-10°C)	6.0 (-10°C)
	Annual electricity consumption ⁽²⁾	at bivalent temperature	kW	–	3.0 (-10°C)	3.6 (-10°C)	4.5 (-10°C)	6.0 (-10°C)
		at operation limit temperature	kW	–	2.5 (-15°C)	3.2 (-15°C)	4.2 (-15°C)	6.0 (-15°C)
Operating Current (Max)	Back up heating capacity	kW	–	0.0 (-10°C)	0.0 (-10°C)	0.0 (-10°C)	0.0 (-10°C)	
	Annual electricity consumption ⁽²⁾	kWh/a	–	807	987	1369	1816	
	SEER ⁽⁴⁾		–	5.2	5.1	4.6	4.6	
	Capacity	Energy efficiency class		–	A+++	A+++	A++	A++
		Rated	kW	–	3.2	4.0	6.0	6.8
Indoor Unit	Total Input	Min-Max	kW	–	0.7 - 5.4	0.9 - 6.3	1.0 - 8.2	1.8 - 9.3
		Rated	kW	–	0.600	0.820	1.480	1.810
	Operating Current (Max)	A	–	7.1	9.9	13.9	15.2	
	Input	Rated	kW	–	0.027	0.027	0.034	0.040
		Operating Current (Max)	A	–	0.3	0.3	0.4	0.4
Outdoor Unit	Dimensions	H*W*D	mm	307-890-233	307-890-233	307-890-233	307-890-233	
	Weight	kg	–	14.5 (W) 15.5 (V, R, B)	14.5 (W) 15.5 (V, R, B)	14.5 (W) 15.5 (V, R, B)	15 (W) 16 (V, R, B)	
	Air Volume (SLo-Lo-Mid-Hi-SHi) ⁽³⁾	Cooling	m ³ /min	–	4.7 - 5.9 - 7.1 - 9.2 - 12.4	4.7 - 5.9 - 7.1 - 9.2 - 12.4	4.7 - 5.9 - 7.1 - 9.2 - 13.0	5.7 - 7.6 - 8.8 - 10.6 - 13.9
		Heating	m ³ /min	–	4.5 - 6.6 - 7.5 - 11.0 - 13.9	4.5 - 6.6 - 7.5 - 11.0 - 13.9	4.5 - 6.6 - 7.5 - 11.0 - 13.9	5.4 - 6.4 - 8.5 - 10.7 - 15.7
	Sound Level (SPL) (SLo-Lo-Mid-Hi-SHi) ⁽³⁾	Cooling	dB(A)	–	19 - 23 - 29 - 36 - 42	19 - 23 - 29 - 36 - 42	19 - 24 - 29 - 36 - 43	27 - 31 - 35 - 39 - 46
		Heating	dB(A)	–	19 - 24 - 29 - 38 - 45	19 - 24 - 29 - 38 - 45	19 - 24 - 29 - 38 - 45	25 - 29 - 34 - 39 - 47
	Sound Level (PWL)	Cooling	dB(A)	–	58	58	59	60
		Heating	dB(A)	–	58	58	59	60
	Dimensions	H*W*D	mm	–	550-800-285	550-800-285	714-800-285	880-840-330
		Weight	kg	–	33	34	40	53
Outdoor Unit	Air Volume	Cooling	m ³ /min	–	34.3	34.3	40.0	48.8
		Heating	m ³ /min	–	32.7	32.7	40.5	55.0
	Sound Level (SPL)	Cooling	dB(A)	–	46	49	51	55
		Heating	dB(A)	–	49	50	54	55
	Sound Level (PWL)	Cooling	dB(A)	–	60	61	64	65
Ext. Piping	Operating Current (Max)	A	–	6.8	9.6	13.5	14.8	
	Breaker Size	A	–	10	10	16	16	
	Diameter	Liquid/Gas	mm	–	6.35/9.52	6.35/9.52	6.35/9.52	6.35/12.7
	Max.Length	Out-In	m	–	20	20	30	30
	Max.Height	Out-In	m	–	12	12	12	15
Guaranteed Operating Range (Outdoor)	Cooling	°C	–	-10 ~ +46	-10 ~ +46	-10 ~ +46	-10 ~ +46	
	Heating	°C	–	-15 ~ +24	-15 ~ +24	-15 ~ +24	-15 ~ +24	

(1) Refrigerant leakage contributes to climate change. Refrigerant with lower global warming potential (GWP) would contribute less to global warming than a refrigerant with higher GWP, if leaked to the atmosphere. This appliance contains a refrigerant fluid with a GWP equal to 550. This means that if 1 kg of this refrigerant fluid would be leaked to the atmosphere, the impact on global warming would be 550 times higher than 1 kg of CO₂ over a period of 100 years. Never try to interfere with the refrigerant circuit yourself or disassemble the product yourself and always ask a professional.

The GWP of R32 is 675 in the IPCC 4th Assessment Report.

(2) Energy consumption based on standard test results. Actual energy consumption will depend on how the appliance is used and where it is located.

(3) SHi: Super High

(4) SEER, SCOP and other related description are based on COMMISSION DELEGATED REGULATION (EU) No.626/2011. The temperature conditions for calculating SCOP are based on "Average Season".

(5) Please see page 57-59 for heating (warmer season) specifications.

MSZ-AY SERIES

The AY series has an excellent cleanliness feature and ranges to two models: the VGK model comes standard with the V Blocking Filter, which has antiviral, antibacterial, anti-mold, and anti-allergen effects, and the VGKP model comes standard with Plasma Quad Plus, which can collect PM2.5 dust in addition to these effects. The AY series has also been upgraded in terms of quietness, energy efficiency, and ease of installation. Enjoy a comfortable air environment with the AY series.

MSZ-AY25/35/42/50VGK(P)

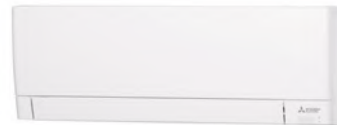

High energy saving



The AY series has achieved either the "Rank A+++" or "Rank A++" for SEER and SCOP as energy-savings rating. The high-efficiency air conditioner is eco-friendly and economical.

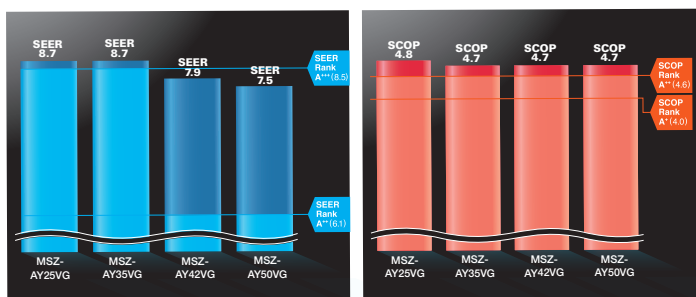

Matt and Sophisticated Design



Rounded corners

The rounded corners give a soft impression that blends in with any room.

Simple and Compact size

While the plasma is built-in, the angle of the curve is carefully designed to maintain the compact unit.

The elegant and sophisticated design has been created to fit in any room, with careful attention to detail in the surface finish and panel angles.



Plasma Quad Plus (only VGKP model)



You can enjoy the clean and safe air by Plasma Quad Plus.

Plasma Quad Plus is a plasma-based filtering system which contributes to a better air quality in your room. Plasma Quad Plus applies a voltage of approximately 6,000 volts to the electrode to generate plasma, effectively removing various kinds of airborne particles such as viruses, bacteria, mold, allergen, dust, and PM2.5.

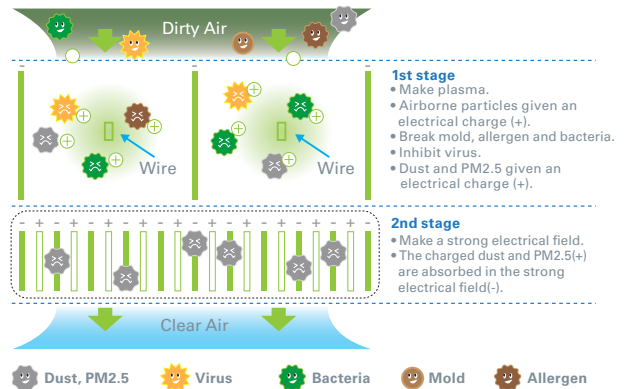

We have confirmed Plasma Quad Plus inhibits 99% of adhered COVID-19.

*Tested Organization: National Hospital Organization Sendai Medical Center, Test Report No: R4-001 Test result: Neutralised 99% of influenza A virus in 210.5 minutes in a 25m³ test space.

*Tested Organization: Japan Textile Products Quality and Technology Center, Test Report No: 20KB070569, Tested Materials: SARS-CoV-2, Test Method: Original (The test was conducted on the Plasma Quad device alone, not designed to evaluate product performance.) Test Result: Inhibited 99.8% in 360 minutes. The result without the effect of natural attenuation is 96.3%.



V Blocking Filter (only VGK model)

“V Blocking Filter” with antiviral effect inhibits 99% of adhered virus, and other harmful substances, such as bacteria, mold and allergen. Two-layered filter with non-woven fabric and electrostatic filter can effectively capture and remove small particles from the air in your room.

*Virus Test method: JIS L 1922, Tested Organization: Guangdong Detection Center of Microbiology, Test Report No: 2020FM30156R02D, Test result: 99% neutralized in 24 hours in a Testing Container.

Bacteria Test method: JIS L 1902, Tested Organization: Boken Quality Evaluation Institute, Test Report No: 29020006998-1, Test result: 99% neutralized in 18 hours in a Petri dish.

Mold Test method: JIS Z 2911, Tested Organization: Boken Quality Evaluation Institute, Test Report No: 29020006906-1, Test result: No mold growth was confirmed.

Allergen Test method: ELISA, Tested Organization: Daiwa Chemical Industries Co., Ltd, Test Report No: 2021B267, Test result: 96% neutralized in 24 hours.

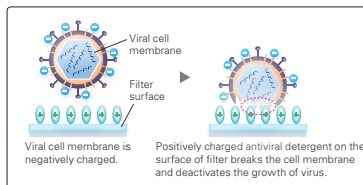

Dual Barrier Coating

Mitsubishi Electric's Dual Barrier Coating prevents dust and greasy dirt from accumulating on the inner surface of the indoor unit, keeping your air conditioner clean. Hydrophilic material resists oil stains and hydrophobic material resists dust stains.

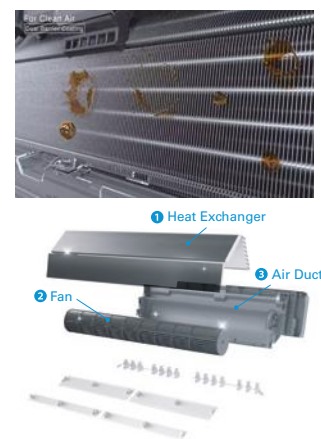
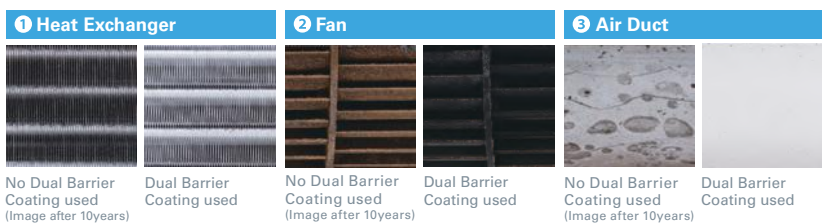

Self Clean

When Self Clean Mode is activated, fan operation starts after cooling/dry mode. This operation helps to dry inside indoor unit to prevent molds and odors. You can feel the clean air without frequent cleaning by yourself.

1 High humidity inside the unit, which can lead to mold growth and odors.

2 Airflow operation suppresses mycelial growth.

3 Maintains clean unit interior.

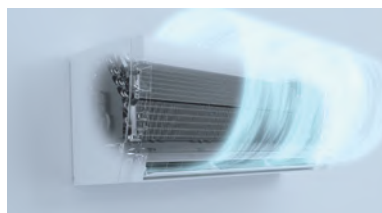
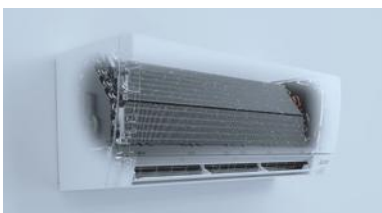

*When SELF CLEAN operation is set, it performs for 25 minutes when unit is stopped after COOL/DRY operation. SELF CLEAN operation performs when: COOL/DRY is operated more than 3 minutes. The fan is stopped for the first 3 minutes. Then, the horizontal vane is set to higher than angle 1 and the fan is operated for 25 minutes. To enable this function, press “Self Clean Mode” button on remote controller. (Default setting is OFF)



Quietness 18dB

Noiseless 18dB



Quiet, relaxing space is within reach. Operational noise is 18dB (25/35 classes), which is so quiet that you might even forget the air conditioner is on.



Night mode

When Night Mode is activated using the wireless remote controller, air conditioner operation will switch to the following settings.

- The brightness of the operation indicator lamp will become dimmer.
- The beeping sound will be disabled.
- The outdoor operating noise will be 3dB lower than the rated operating noise specification.

*The cooling/heating capacity may drop.

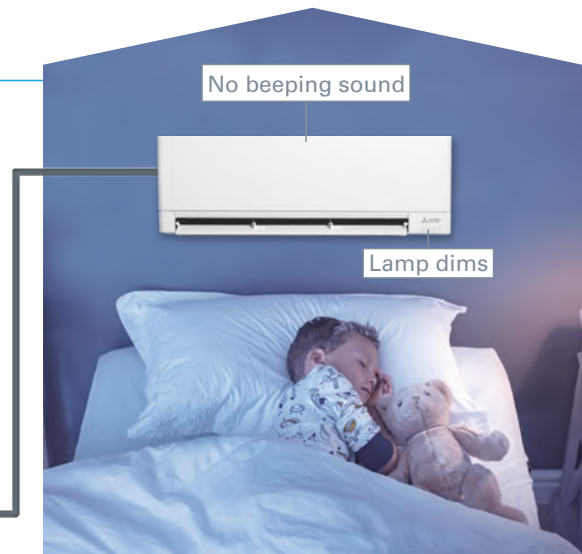

Wider Heating Operation Range

Mitsubishi Electric technology ensures that the unit will operate even when the outside temperature is down to -20°C.

Wider Heating Operation Range

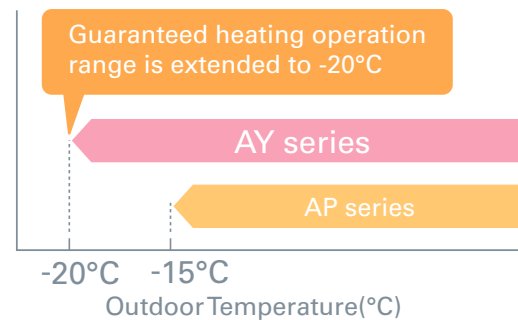

Outdoor Units for Cold Region

Single split-type outdoor units are available in both standard and heater-equipped units. An electric heater is installed in each unit to prevent freezing in cold outdoor environments.

Standard Units

Heater Installed



MUZ-AY25/35/42VG



MUZ-AY50VG



MUZ-AY25/35/42VGH



MUZ-AY50VGH

Back Plate with a Hole

With a hole as default in the center of the back plate, the piping can be easily taken out from the back. The edge of the hole is reinforced to ensure the strength.

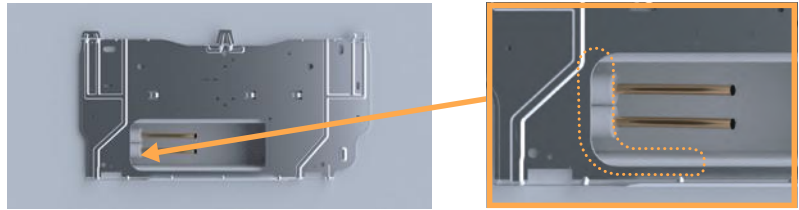

The edge of the hole is reinforced to ensure the strength.

Spacer

A part of the packing material can be used as a spacer to lift indoor unit during the left-side piping work, which makes stable installation work possible.



Built-in Wi-Fi & App Control

Indoor unit is equipped with Wi-Fi interface which allows you to access MELCloud app, providing you with a flexible control of air conditioner on your smartphone, tablets, and PC.

[key control and monitoring features]

- On/Off
- Check and set driving conditions
- Notification of weather conditions from current location
- Weekly timer set
- Energy consumption check
- Air purification on/off



Easy Wi-Fi Set Up

You can easily connect Wi-Fi adaptor in the indoor unit and your local router with just a simple operation of remote controller.

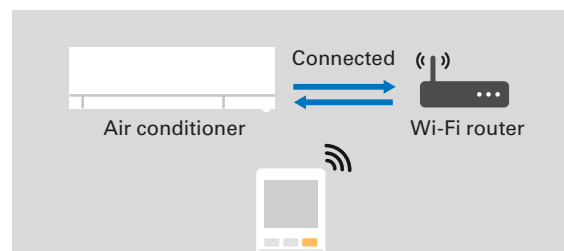

Remote Controller features

The remote controller screen is equipped with LED back-light. The luminous screen allows you to check the setting easily even in the dark. You can easily connect Wi-Fi adaptor in the indoor unit and your local router with just a simple operation of remote controller.



MSZ-AP SERIES

Introducing a compact and stylish indoor unit with various capacity, designed to match number of rooms. High performance indoor and outdoor units enabled to achieve "Rank A+++" for SEER. *MSZ-AP20VG



MSZ-AP15/20VG



MSZ-AP60/71VG



High energy saving

The classes from the low-capacity 25 to the high-capacity 60, have achieved either the "Rank A+++" or "Rank A++" for SEER and SCOP as energy-savings rating. Our air conditioners are contributing to reduce energy consumption in a wide range.

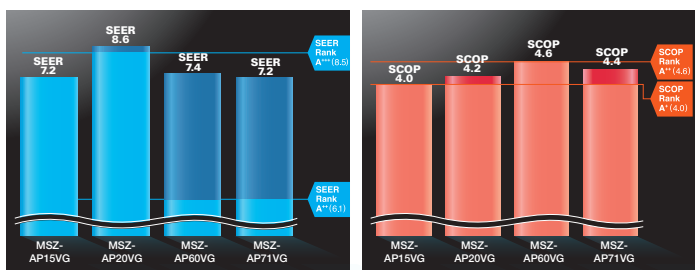

Compact and stylish

All the classes are introduced as single-split and multi-systems. From small rooms to living rooms, it is possible to coordinate residences with a unified design.

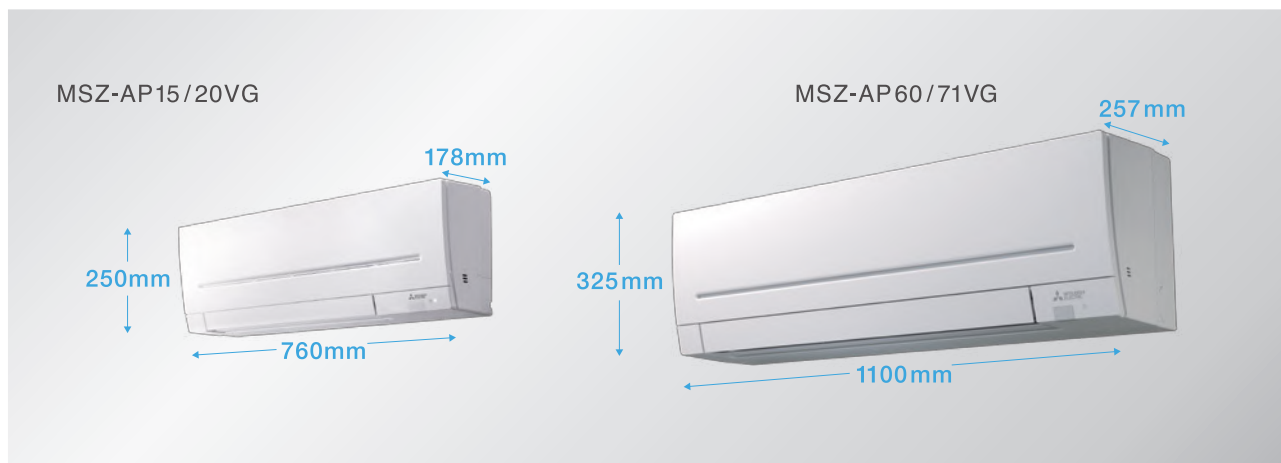

Living



Study



Bedroom



Evolved comfortable convenience function

Horizontal Airflow

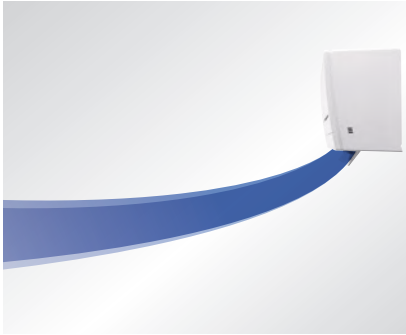

The new airflow control which spreads across the ceiling eliminates the uncomfortable drafty feeling.

Auto Vane Control

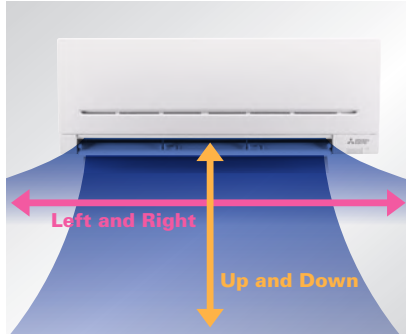

Auto vanes can be moved left and right, and up and down using the remote controller.

The Function



“Weekly Timer”



Easily set desired temperatures and operation start/stop times to match lifestyle patterns. Reduce wasted energy consumption by using the timer to prevent forgetting to turn off the unit and eliminate temperature setting adjustments.

■ Example Operation Pattern (Winter/Heating mode)

	Mon.	Tues.	Wed.	Thurs.	Fri.	Sat.	Sun.
6:00	ON 20°C	ON 20°C	ON 20°C	ON 20°C	ON 20°C	ON 20°C	ON 20°C
8:00	Automatically changes to high-power operation at wake-up time						
10:00							
12:00	OFF	OFF	OFF	OFF	OFF	ON 18°C	ON 18°C
14:00	Automatically turned off during work hours					Midday is warmer, so the temperature is set lower	
16:00							
18:00	ON 20°C	ON 20°C	ON 20°C	ON 20°C	ON 20°C	ON 20°C	ON 20°C
20:00	Automatically turns on, synchronized with arrival at home					Automatically raises temperature setting to match time when outside-air temperature is low	
22:00							
(during sleeping hours)	ON 18°C	ON 18°C	ON 18°C	ON 18°C	ON 18°C	ON 18°C	ON 18°C
	Automatically lowers temperature at bedtime for energy-saving operation at night						

Settings

Pattern Settings: Input up to four settings for each day

Settings: •Start/Stop operation •Temperature setting *The operation mode cannot be set.

■ Easy set-up using dedicated buttons



The remote controller is equipped with buttons that are used exclusively for setting the Weekly Timer. Setting operation patterns is easy and quick.



How to set the Weekly Timer

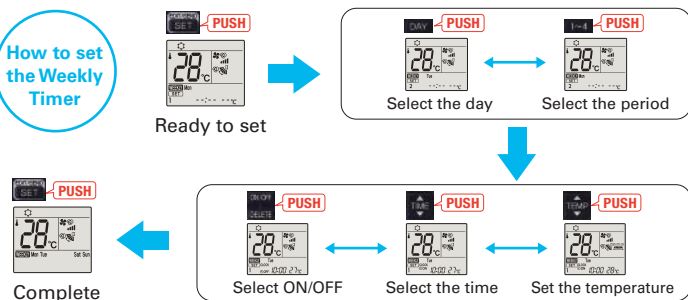

- Start by pushing the “SET” button and follow the instructions to set the desired patterns. Once all of the desired patterns are input, point the top end of the remote controller at the indoor unit and push the “SET” button one more time. (Push the “SET” button only after inputting all of the desired patterns into the remote controller memory. Pushing the “CANCEL” button will end the set-up process without sending the operation patterns to the indoor unit).
- It takes a few seconds to transmit the Weekly Timer operation patterns to the indoor unit. Please continue to point the remote controller at the indoor unit until all data has been sent.
- When “Weekly Timer” is set, temperature can not be set 10°C. (only for 15/20 models)

Low Standby Power

Electrical devices consume standby power even when they are not in actual use. While we obviously strive to reduce power consumption during actual use, reducing this wasted power that cannot be seen is also very important.

without
“Low standby power”

around **10W**

with
“Low standby power”

below
1W

around
90% reduction

V Blocking Filter

V Blocking Filter
Virus 99.99%

V Blocking Filter with antiviral effect inhibits 99% of adhered virus, and other harmful substances, such as bacteria, mold and allergen. Two-layered filter with non-woven fabric and electrostatic filter can effectively capture and remove small particles from the air in your room.

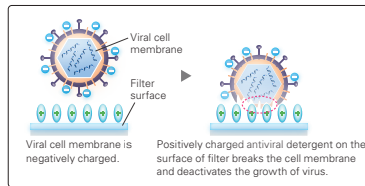

Air Purifying Filter

Air Purifying Filter
Dust 99.99%

This filter generates stable antibacterial and deodorising effects. The size of the three-dimensional surface has been increased as well, enlarging the filter capture area. These features give the Air Purifying Filter better dust collection performance than conventional filters. The superior air-cleaning effectiveness raises room comfort yet another level.

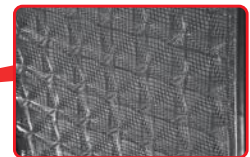
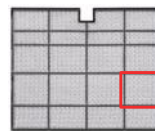

* It is okay to wash the filter with water (air-cleaning effect is maintained)

3D surface (Waved surface)

“i save” Mode

i save
Energy 99.99%

“i save” is a simplified setting function that recalls the preferred(preset) temperature by pressing a single button on the remote controller. Press the same button twice in repetition to immediately return to the previous temperature setting. Using this function contributes to comfortable, waste-free operation, realising the most suitable air conditioning settings and saving on power consumption when, for example, leaving the room or going to bed.

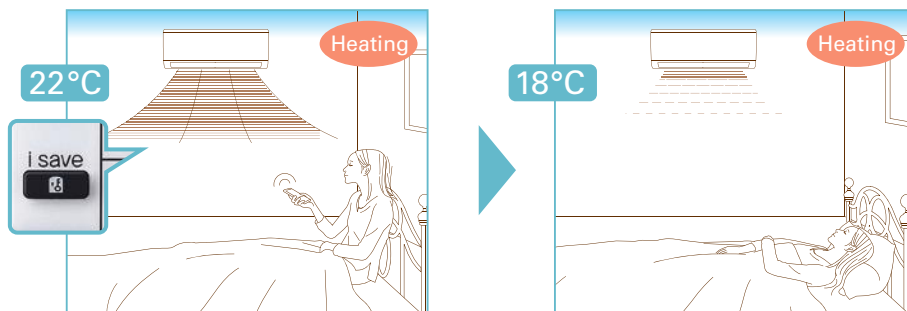

* Temperature can be preset to 10°C when heating in the “i-save” mode.

Night Mode



When Night Mode is activated using the wireless remote controller, air conditioner operation will switch to the following settings.

- The brightness of the operation indicator lamp will become dimmer.
- The beeping sound will be disabled.
- The outdoor operating noise will drop to 3dB lower than the rated operating noise specification.

*The cooling/heating capacity may drop.

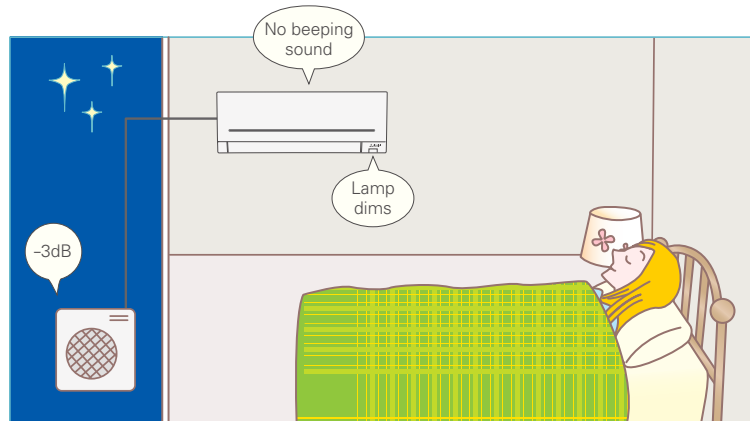

Built-in Wi-Fi Interface

(MSZ-AP15/20/60/71VGK)



The indoor unit is equipped with a Wi-Fi Interface inside an exclusive pocket in the unit.

This eliminates the need to install a Wi-Fi interface, and also contributes to the beautiful appearance since the interface is hidden.

LED Backlight Remote Controller



Backlight function incorporated, making screen easy to read in the dark. Even in dimly lit rooms, the screen can be seen clearly for trouble-free remote controller operation.



MSZ-AY SERIES



Indoor Unit

R32 R410A



MSZ-AY25/35/42/50VGK(P)

Outdoor Unit

R32



MUZ-AY25/35/42VG(H)



MUZ-AY50VG(H)

Remote Controller



Type		Inverter Heat Pump									
Indoor Unit		MSZ-AY25VGK(P)	MSZ-AY25VGK(P)	MSZ-AY35VGK(P)	MSZ-AY35VGK(P)	MSZ-AY42VGK(P)	MSZ-AY42VGK(P)	MSZ-AY50VGK(P)	MSZ-AY50VGK(P)	MSZ-AY50VGK(P)	
Outdoor Unit		MUZ-AY25VG	MUZ-AY25VGH	MUZ-AY35VG	MUZ-AY35VGH	MUZ-AY42VG	MUZ-AY42VGH	MUZ-AY50VG	MUZ-AY50VGH	MUZ-AY50VGH	
Refrigerant		R32 ⁽¹⁾									
Power Supply	Source	Outdoor Power supply									
	Outdoor (V / Phase / Hz)	230/Single/50									
Cooling	Design load	kW	2.5	2.5	3.5	3.5	4.2	4.2	5.0	5.0	
	Annual electricity consumption ⁽²⁾	kWh/a	100	100	141	141	186	186	232	232	
	SEER ⁽⁴⁾		8.7	8.7	8.7	8.7	7.9	7.9	7.5	7.5	
	Capacity	Energy efficiency class		A+++	A+++	A+++	A+++	A++	A++	A++	A++
		Rated	kW	2.5	2.5	3.5	3.5	4.2	4.2	5.0	5.0
Heating (Average Season) ⁽³⁾	Declared Capacity	at reference design temperature	kW	2.4 (-10°C)	2.4 (-10°C)	2.9 (-10°C)	2.9 (-10°C)	3.8 (-10°C)	3.8 (-10°C)	4.2 (-10°C)	4.2 (-10°C)
		at bivalent temperature	kW	2.4 (-10°C)	2.4 (-10°C)	2.9 (-10°C)	2.9 (-10°C)	3.8 (-10°C)	3.8 (-10°C)	4.2 (-10°C)	4.2 (-10°C)
	at operation limit temperature	kW	1.9 (-20°C)	1.9 (-20°C)	2.0 (-20°C)	2.0 (-20°C)	2.7 (-20°C)	2.7 (-20°C)	3.0 (-20°C)	3.0 (-20°C)	
	Back up heating capacity	kW	0.0 (-10°C)	0.0 (-10°C)	0.0 (-10°C)	0.0 (-10°C)	0.0 (-10°C)	0.0 (-10°C)	0.0 (-10°C)	0.0 (-10°C)	
	Annual electricity consumption ⁽²⁾	kWh/a	697	709	863	880	1131	1146	1248	1265	
		SCOP ⁽⁴⁾		4.8	4.7	4.7	4.6	4.6	4.6	4.7	4.6
	Capacity	Energy efficiency class		A++	A++	A++	A++	A++	A++	A++	A++
		Rated	kW	3.2	3.2	4.0	4.0	5.2	5.2	5.5	5.5
	Total Input	Min	kW	1.0	1.0	1.3	1.3	1.3	1.3	1.4	1.4
		Max at 7°C	kW	4.1	4.1	4.6	4.6	6.0	6.0	7.3	7.3
Rated		kW	0.780	0.780	1.030	1.030	1.390	1.390	1.470	1.470	
Operating Current (Max)		A	7.6	7.6	7.6	7.6	9.9	9.9	13.8	13.8	
	Input	kW	0.026	0.026	0.026	0.026	0.032	0.032	0.032	0.032	
Indoor Unit	Operating Current (Max)		A	0.3	0.3	0.3	0.3	0.3	0.3	0.3	
	Dimensions		H*W*D	mm	299-798-245	299-798-245	299-798-245	299-798-245	299-798-245	299-798-245	299-798-245
	Weight		kg	27	27	28.5	28.5	34	34	40.5	
	Air Volume	Cooling	m ³ /min	3.6-5.0-6.3-7.8-10.5	3.6-5.0-6.3-7.8-10.5	3.6-5.0-6.3-7.8-11.1	3.6-5.0-6.3-7.8-11.1	4.5-5.7-7.0-8.4-10.5	4.5-5.7-7.0-8.4-10.5	5.2-6.4-7.5-9.1-11.7	5.2-6.4-7.5-9.1-11.7
		Heating	m ³ /min	4.0-5.0-6.6-8.0-11.8	4.0-5.0-6.6-8.0-11.8	4.0-5.0-6.6-8.0-11.8	4.0-5.0-6.6-8.0-11.8	4.4-5.4-7.0-8.6-12.9	4.4-5.4-7.0-8.6-12.9	4.8-5.7-7.3-9.1-12.9	4.8-5.7-7.3-9.1-12.9
	Sound Level (SPL) (SLo-Lo-Mid-Hi-SH) ⁽⁵⁾	Cooling	dB(A)	18-24-30-36-42	18-24-30-36-42	18-24-31-38-45	18-24-30-36-42	21-29-34-38-42	21-29-34-38-42	28-33-36-40-44	28-33-36-40-44
		Heating	dB(A)	18-24-34-39-45	18-24-34-39-45	18-24-31-38-45	18-24-31-38-45	21-29-35-40-45	21-29-35-40-45	28-33-38-43-48	28-33-38-43-48
	Sound Level (PWL)		Cooling	dB(A)	57	57	57	57	57	58	58
	Dimensions		H*W*D	mm	550-800-285	550-800-285	550-800-285	550-800-285	550-800-285	714-800-285	714-800-285
	Weight		kg	27	27	28.5	28.5	34	34	40.5	40.5
Outdoor Unit	Air Volume		Cooling	m ³ /min	32.2	32.2	32.2	32.2	32	32	40.5
			Heating	m ³ /min	29.8	29.8	29.8	29.8	28.1	28.1	37.4
	Sound Level (SPL)	Cooling	dB(A)	47	47	49	49	50	50	52	52
		Heating	dB(A)	48	48	50	50	51	51	52	52
	Sound Level (PWL)		Cooling	dB(A)	59	59	61	61	61	61	64
Operating Current (Max)		A	7.3	7.3	7.3	7.3	9.6	9.6	13.5	13.5	
Breaker Size		A	10	10	10	10	10	10	16	16	
Ext. Piping	Diameter		Liquid/Gas	mm	6.35 / 9.52	6.35 / 9.52	6.35 / 9.52	6.35 / 9.52	6.35 / 9.52	6.35 / 9.52	6.35 / 9.52
	Chargeless piping length		Out-In	m	7.5	7.5	7.5	7.5	7.5	7.5	7.5
	Max.Length		Out-In	m	20	20	20	20	20	20	20
	Max.Height		Out-In	m	12	12	12	12	12	12	12
Guaranteed Operating Range (Outdoor)	Cooling	°C	-10 ~ +46	-10 ~ +46	-10 ~ +46	-10 ~ +46	-10 ~ +46	-10 ~ +46	-10 ~ +46	-10 ~ +46	
	Heating	°C	-20 ~ +24	-20 ~ +24	-20 ~ +24	-20 ~ +24	-20 ~ +24	-20 ~ +24	-20 ~ +24	-20 ~ +24	

(1) Refrigerant leakage contributes to climate change. Refrigerant with lower global warming potential (GWP) would contribute less to global warming than a refrigerant with higher GWP, if leaked to the atmosphere. This appliance contains a refrigerant fluid with a GWP equal to 550. This means that if 1 kg of this refrigerant fluid would be leaked to the atmosphere, the impact on global warming would be 550 times higher than 1 kg of CO₂ over a period of 100 years. Never try to interfere with the refrigerant circuit yourself or disassemble the product yourself and always ask a professional.

The GWP of R32 is 675 in the IPCC-4th Assessment Report.

(2) Energy consumption based on standard test results. Actual energy consumption will depend on how the appliance is used and where it is located.

(3) SHi: Super High

(4) SEER, SCOP and other related description are based on COMMISSION DELEGATED REGULATION (EU) No.626/2011. The temperature conditions for calculating SCOP are based on "Average Season".

(5) Please see page 57-58 for heating (warmer season) specifications.

MSZ-AP SERIES



Indoor Unit

R32 R410A

※VGK model Wi-Fi Interface built-in.



MSZ-AP15/20VG(K)



MSZ-AP60/71VG(K)

Outdoor Unit

R32



MUZ-AP15VG



MUZ-AP20VG



MUZ-AP60VG



MUZ-AP71VG

Remote Controller



Type	Inverter Heat Pump						
Indoor Unit	MSZ-AP15VG(K)	MSZ-AP20VG(K)	MSZ-AP60VG(K)	MSZ-AP71VG(K)			
Outdoor Unit	MUZ-AP15VG	MUZ-AP20VG	MUZ-AP60VG	MUZ-AP71VG			
Refrigerant	Single: R32 ⁽¹⁾ / Multi: R410A or R32 ⁽¹⁾		Single: R32 ⁽¹⁾ / Multi: R32 ⁽¹⁾				
Power Supply	Outdoor Power supply						
Source	230 / Single / 50						
Cooling	Design load	kW	1.5	2.0	6.1	7.1	
	Annual electricity consumption ⁽²⁾	kWh/a	72	81	288	345	
	SEER ⁽⁴⁾		7.2	8.6	7.4	7.2	
	Energy efficiency class		A++	A+++	A++	A++	
		Rated	kW	1.5	2.0	6.1	7.1
Capacity	Min-Max	kW	0.5-2.2	0.6-2.7	1.4-7.3	2.0-8.7	
	Total Input	Rated	kW	0.370	0.460	1.590	2.010
Heating (Average Season) ⁽⁵⁾	Design load	kW	1.6 (-10°C)	2.3 (-10°C)	4.6 (-10°C)	6.7 (-10°C)	
		at reference design temperature	kW	1.6 (-10°C)	2.3 (-10°C)	4.6 (-10°C)	6.7 (-10°C)
	Declared Capacity	at bivalent temperature	kW	1.6 (-10°C)	2.3 (-10°C)	4.6 (-10°C)	6.7 (-10°C)
		at operation limit temperature	kW	1.6 (-15°C)	2.2 (-15°C)	3.7 (-15°C)	5.4 (-15°C)
	Back up heating capacity	kW	0.0 (-10°C)	0.0 (-10°C)	0.0 (-10°C)	0.0 (-10°C)	
	Annual electricity consumption ⁽²⁾	kWh/a	559	766	1398	2132	
	SCOP ⁽⁴⁾		4.0	4.2	4.6	4.4	
		Energy efficiency class		A+	A+	A++	A+
	Capacity	Rated	kW	2.0	2.5	6.8	8.1
		Min-Max	kW	0.5-3.1	0.5-3.5	2.0-8.6	2.2-10.3
Total Input	Rated	kW	0.500	0.600	1.670	2.120	
Operating Current (Max)	Input	Rated	A	5.5	7.0	14.1	16.4
	Operating Current (Max)	A	0.17	0.2	0.5	0.4	
	Dimensions	H*W*D	mm	250-760-178	250-760-178	325-1100-257	325-1100-257
	Weight	kg	8.2	8.2	16.0	17.0	
	Indoor Unit	Air Volume (SLo-Lo-Mid-Hi-SHi ⁽³⁾)	Cooling	m ³ /min	3.5 - 3.9 - 4.6 - 5.5 - 6.4	3.5 - 3.9 - 4.6 - 5.5 - 6.9	9.4 - 11.0 - 13.2 - 16.0 - 18.9
Heating			m ³ /min	3.7 - 4.4 - 5.0 - 6.0 - 6.8	3.7 - 4.4 - 5.0 - 6.0 - 7.3	10.8 - 13.4 - 15.4 - 17.4 - 20.3	10.2 - 11.5 - 13.2 - 15.3 - 19.2
Sound Level (SPL) (SLo-Lo-Mid-Hi-SHi ⁽³⁾)		Cooling	dB(A)	21 - 26 - 30 - 35 - 40	21 - 26 - 30 - 35 - 42	29 - 37 - 41 - 45 - 48	30 - 37 - 41 - 45 - 49
		Heating	dB(A)	21 - 26 - 30 - 35 - 40	21 - 26 - 30 - 35 - 42	30 - 37 - 41 - 45 - 48	30 - 37 - 41 - 45 - 51
Sound Level (PWL)		Cooling	dB(A)	59	60	65	65
		Heating	dB(A)	59	60	65	65
Dimensions		H*W*D	mm	538-699-249	550-800-285	714-800-285	880-840-330
Weight		kg	23	31	40	55	
Air Volume		Cooling	m ³ /min	26	32.2	52.1	54.1
		Heating	m ³ /min	21	29.8	52.1	47.9
Sound Level (SPL)	Cooling	dB(A)	50	47	56	56	
	Heating	dB(A)	50	48	57	55	
Sound Level (PWL)	Cooling	dB(A)	63	59	69	69	
	Heating	dB(A)	63	59	69	69	
Operating Current (Max)	A	5.3	6.8	13.6	16.0		
Breaker Size	A	10	10	16	20		
Ext. Piping	Diameter	Liquid/Gas	mm	6.35 / 9.52	6.35 / 9.52	6.35 / 12.7	6.35 / 12.7
	Max.Length	Out-In	m	20	20	30	30
	Max.Height	Out-In	m	12	12	15	15
Guaranteed Operating Range (Outdoor)	Cooling	°C	-10 ~ +46	-10 ~ +46	-10 ~ +46	-10 ~ +46	
	Heating	°C	-15 ~ +24	-15 ~ +24	-15 ~ +24	-15 ~ +24	

(1) Refrigerant leakage contributes to climate change. Refrigerant with lower global warming potential (GWP) would contribute less to global warming than a refrigerant with higher GWP. This appliance contains a refrigerant fluid with a GWP equal to 550. This means that if 1 kg of this refrigerant fluid would be leaked to the atmosphere, the impact on global warming would be 550 times higher than 1 kg of CO₂ over a period of 100 years. Never try to interfere with the refrigerant circuit yourself or disassemble the product yourself and always ask a professional.

The GWP of R32 is 675 in the IPCC 4th Assessment Report.

(2) Energy consumption based on standard test results. Actual energy consumption will depend on how the appliance is used and where it is located.

(3) SHi: Super High

(4) SEER, SCOP and other related description are based on COMMISSION DELEGATED REGULATION (EU) No.626/2011. The temperature conditions for calculating SCOP are based on "Average Season".

(5) Please see page 57-59 for heating (warmer season) specifications.

MSZ-E SERIES

Developed to complement modern interior room décor, Kirigamine ZEN air conditioners are available in three colours specially chosen to blend in naturally wherever installed.

MSZ-EF18-50VGB



Stylish Line-up Matches Any Room Décor

The streamlined wall-mounted indoor units have eloquent silver-bevelled edges, expressing sophistication and quality. Combining impressively low power consumption and quiet yet powerful performance, these units provide a best-match scenario for diverse interior designs while simultaneously ensuring maximum room and energy savings.



Energy-efficient Operation



All models in the series have achieved high energy-savings rating, and are contributing to reduced energy consumption in homes, offices and a range of other settings. Offered in a variety of output capacities and installation patterns, the vast applicability promises an ideal match for any user.

Indoor \ Outdoor	Rank A for single connection MUZ-EF25/35VG(H) MUZ-EF42/50VG	Compatibility MXZ					
		2F33VF	2F42VF	2F53VF	3F54VF	3F68VF	4F72VF
MSZ-EF18VG	-	✓	✓	✓	✓	✓	✓
MSZ-EF22VG	-	✓	✓	✓	✓	✓	✓
MSZ-EF25VG	A+++ / A++(A+++)	✓	✓	✓	✓	✓	✓
MSZ-EF35VG	A+++ / A++(A+++)		✓	✓	✓	✓	✓
MSZ-EF42VG	A++ / A+			✓	✓	✓	✓
MSZ-EF50VG	A++ / A+			✓	✓	✓	✓

*VEH

Quiet Comfort All Day Long

Mitsubishi Electric's advanced "Silent Mode" fan speed setting provides super-quiet operation as low as 19dB for EF18/22/25 models for cooling. This unique feature makes the Kirigamine ZEN series ideal for use in any situation.

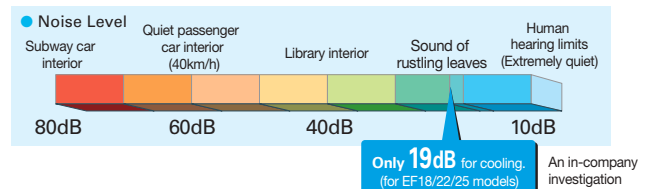

Superior Exterior and Operating Design Concept

The indoor unit of the Kirigamine ZEN keeps its amazingly thin form even during operation. The only physical change notable is the movement of the variable vent. As a result, a slim attractive look is maintained.

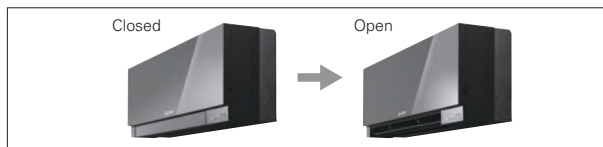

V Blocking Filter



V Blocking Filter with antiviral effect inhibits 99% of adhered virus, and other harmful substances, such as bacteria, mold and allergen.

Two-layered filter with non-woven fabric and electrostatic filter can effectively capture and remove small particles from the air in your room.

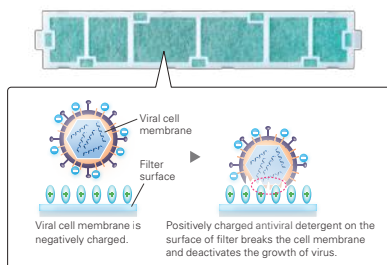

Low Standby Power

Electrical devices consume standby power even when they are not in actual use. While we obviously strive to reduce power consumption during actual use, reducing this wasted power that cannot be seen is also very important.

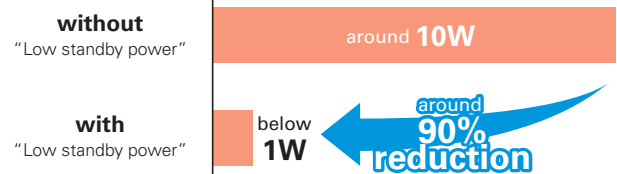

Outdoor Units for Cold Region

(25/35)

Single split-type outdoor units are available in both standard and heater-equipped units. An electric heater is installed in each unit to prevent freezing in cold outdoor environments.

Standard Units



MUZ-EF25/35VG

Heater Installed



MUZ-EF25/35VGH

MSZ-E SERIES



Indoor Unit / Remote Controller

R32 R410A



MSZ-EF18/22/25/35/42/50VG(K)W

White



MSZ-EF18/22/25/35/42/50VG(K)S

Silver



MSZ-EF18/22/25/35/42/50VG(K)B*

Black



reddot award 2015 winner

Outdoor Unit

R32



MUZ-EF25/35VG(H),42VG



MUZ-EF50VG



Type		Inverter Heat Pump									
Indoor Unit		MSZ-EF18VG(K)	MSZ-EF22VG(K)	MSZ-EF25VG(K)	MSZ-EF25VG(K)	MSZ-EF35VG(K)	MSZ-EF35VG(K)	MSZ-EF42VG(K)	MSZ-EF50VG(K)		
Outdoor Unit		for MXZ connection		MUZ-EF25VG	MUZ-EF25VGH	MUZ-EF35VG	MUZ-EF35VGH	MUZ-EF42VG	MUZ-EF50VG		
Refrigerant		R32 ⁽¹⁾									
Power Supply		Outdoor Power supply									
Source		230/Single/50									
Outdoor (V / Phase / Hz)											
Cooling	Design load	kW		2.5	2.5	3.5	3.5	4.2	5.0		
	Annual electricity consumption ⁽²⁾	kWh/a		96	96	139	139	186	233		
	SEER ⁽⁴⁾			9.1	9.1	8.8	8.8	7.9	7.5		
	Energy efficiency class			-	-	A+++	A+++	A+++	A++	A++	
		Capacity	Rated	kW	2.5	2.5	3.5	3.5	4.2	5.0	
		Min-Max	kW	0.9-3.4	0.9-3.4	1.1-4.0	1.1-4.0	0.9-4.6	1.4-5.4		
	Total Input	Rated	kW	0.540	0.540	0.910	0.910	1.200	1.540		
Heating (Average Season) ⁽³⁾	Design load	kW		2.4 (-10°C)	2.4 (-10°C)	2.9 (-10°C)	2.9 (-10°C)	3.8 (-10°C)	4.2 (-10°C)		
	Declared Capacity	at reference design temperature		kW	2.4 (-10°C)	2.4 (-10°C)	2.9 (-10°C)	2.9 (-10°C)	3.8 (-10°C)	4.2 (-10°C)	
		at bivalent temperature		kW	2.4 (-10°C)	2.4 (-10°C)	2.9 (-10°C)	2.9 (-10°C)	3.8 (-10°C)	4.2 (-10°C)	
		at operation limit temperature		kW	2.0 (-15°C)	1.6 (-20°C)	2.4 (-15°C)	1.7 (-20°C)	3.4 (-15°C)	3.5 (-15°C)	
	Back up heating capacity	kW		0.0 (-10°C)	0.0 (-10°C)	0.0 (-10°C)	0.0 (-10°C)	0.0 (-10°C)	0.0 (-10°C)		
	Annual electricity consumption ⁽²⁾	kWh/a		713	727	882	900	1151	1304		
	SCOP ⁽⁴⁾			4.7	4.6	4.6	4.5	4.6	4.5		
	Energy efficiency class			-	-	A++	A++	A+	A++	A+	
Capacity		Rated	kW	3.2	3.2	4.0	4.0	5.4	5.8		
		Min-Max	kW	1.0-4.2	1.0-4.2	1.3-5.1	1.3-5.1	1.3-6.3	1.4-7.5		
	Total Input	Rated	kW	0.700	0.700	0.950	0.950	1.455	1.560		
Operating Current (Max)	Input	Rated	kW	0.026	0.026	0.026	0.030	0.033	0.043		
	Operating Current (Max)	A		0.3	0.3	0.3	0.3	0.3	0.4		
Dimensions	H*W*D	mm		299-885-195	299-885-195	299-885-195	299-885-195	299-885-195	299-885-195		
	Weight	kg		11.5	11.5	11.5	11.5	11.5	11.5		
Indoor Unit	Air Volume	Cooling	m ³ /min	4.0-4.6-6.3-8.3-10.5	4.0-4.6-6.3-8.3-10.5	4.0-4.6-6.3-8.3-10.5	4.0-4.6-6.3-8.3-10.5	4.0-4.6-6.3-8.3-10.5	5.8-6.6-7.7-8.9-11.2	5.8-6.6-7.7-8.9-11.2	
		Heating	m ³ /min	4.0-4.6-6.2-8.9-11.9	4.0-4.6-6.2-8.9-11.9	4.0-4.6-6.2-8.9-11.9	4.0-4.6-6.2-8.9-11.9	4.0-4.6-6.2-8.9-12.7	5.5-6.3-7.8-9.9-13.2	6.4-7.2-9.0-11.1-14.6	
	Sound Level (SPL) (SLo-Lo-Mid-Hi-SH) ⁽⁵⁾	Cooling	dB(A)	19-23-29-36-42	19-23-29-36-42	19-23-29-36-42	19-23-29-36-42	21-24-30-36-42	21-24-30-36-42	28-31-35-39-43	30-33-36-40-43
		Heating	dB(A)	21-24-29-37-45	21-24-29-37-45	21-24-29-37-45	21-24-29-37-45	21-24-30-38-46	21-24-30-38-46	28-30-35-41-48	30-33-37-43-49
	Sound Level (PWL)	Cooling	dB(A)	60	60	60	60	60	60		
Outdoor Unit	Dimensions	H*W*D	mm	-	550-800-285	550-800-285	550-800-285	550-800-285	550-800-285	714-800-285	
		Weight	kg	-	31	31	34	34	35	40	
	Air Volume	Cooling	m ³ /min	-	27.8	27.8	34.3	34.3	32.0	40.2	
		Heating	m ³ /min	-	29.8	29.8	32.7	32.7	32.7	40.2	
	Sound Level (SPL)	Cooling	dB(A)	-	47	47	49	49	50	52	
		Heating	dB(A)	-	48	48	50	50	51	52	
		Sound Level (PWL)	Cooling	dB(A)	58	58	62	62	62	65	
		Operating Current (Max)	A		6.8	6.8	6.8	6.8	9.6	13.6	
	Breaker Size	A		10	10	10	10	12	16		
Ext. Piping	Diameter	Liquid/Gas	mm	-	6.35 / 9.52	6.35 / 9.52	6.35 / 9.52	6.35 / 9.52	6.35 / 9.52	6.35 / 9.52	
	Max.Length	Out-In	m	-	20	20	20	20	30		
	Max.Height	Out-In	m	-	12	12	12	12	15		
Guaranteed Operating Range (Outdoor)	Cooling	°C	-	-10 ~ +46	-10 ~ +46	-10 ~ +46	-10 ~ +46	-10 ~ +46	-10 ~ +46		
	Heating	°C	-	-15 ~ +24	-20 ~ +24	-15 ~ +24	-20 ~ +24	-15 ~ +24	-15 ~ +24		

(1) Refrigerant leakage contributes to climate change. Refrigerant with lower global warming potential (GWP) would contribute less to global warming than a refrigerant with higher GWP, if leaked to the atmosphere. This appliance contains a refrigerant fluid with a GWP equal to 550. This means that if 1 kg of this refrigerant fluid would be leaked to the atmosphere, the impact on global warming would be 550 times higher than 1 kg of CO₂ over a period of 100 years. Never try to interfere with the refrigerant circuit yourself or disassemble the product yourself and always ask a professional.

The GWP of R32 is 675 in the IPCC 4th Assessment Report.

(2) Energy consumption based on standard test results. Actual energy consumption will depend on how the appliance is used and where it is located.

(3) SHi: Super High

(4) SEER, SCOP and other related description are based on COMMISSION DELEGATED REGULATION (EU) No.626/2011. The temperature conditions for calculating SCOP are based on "Average Season".

(5) Please see page 57-58 for heating (warmer season) specifications.

MSZ-BT20/25/35/50VG(K)

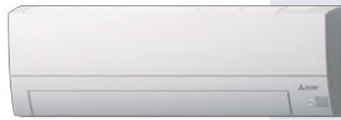

MSZ-BT SERIES

The BT series featured with its high performance, energy efficiency, and simplicity of use brings greater comfort to your room.

High Energy Efficiency for Entire Range of Series



All models in the series, from the low-capacity 20 to the high-capacity 50, have achieved the "Rank A++" for SEER and size 25 and 35 have achieved the "Rank A++" for SCOP as energy-savings rating. For home use, such as in bedrooms and living rooms, to light commercial use, such as in offices, our air conditioners are contributing to reduced energy consumption in a wide range.

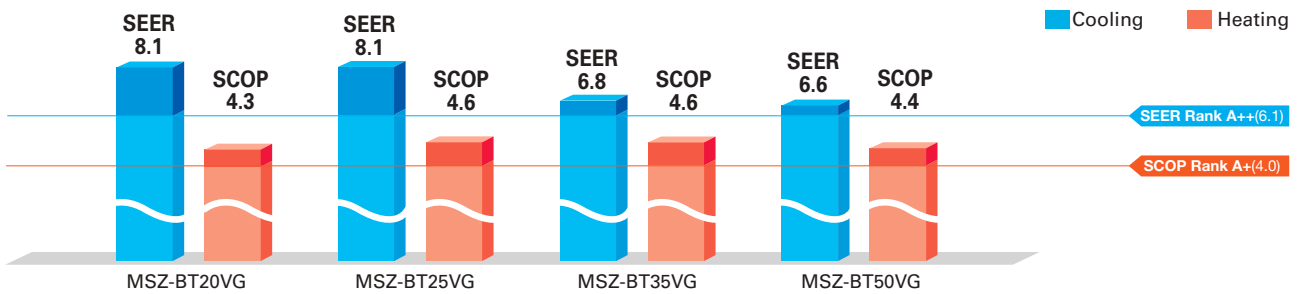

Quiet Operation

The indoor unit noise level is as low as 19dB for AP Series, offering a peaceful inside environment.

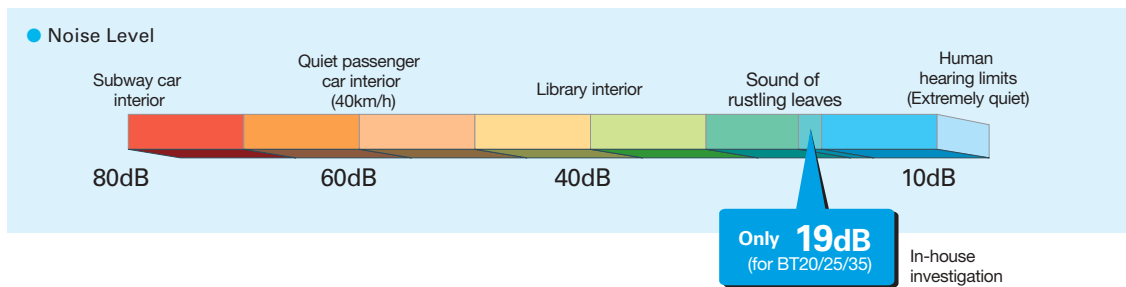

New Remote Controller

New stylish and compact remote controller features easy-read big display and simple button position with fundamental functions.



Built-in Wi-Fi Interface

(MSZ-BT20/25/35/50VGK)

The indoor unit is equipped with a Wi-Fi Interface inside an exclusive pocket in the unit. This eliminates the need to install a Wi-Fi interface, and also contributes to the beautiful appearance since the interface is hidden.

V Blocking Filter

V Blocking Filter with antiviral effect inhibits 99% of adhered virus, and other harmful substances, such as bacteria, mold and allergen. Two-layered filter with non-woven fabric and electrostatic filter can effectively capture and remove small particles from the air in your room.

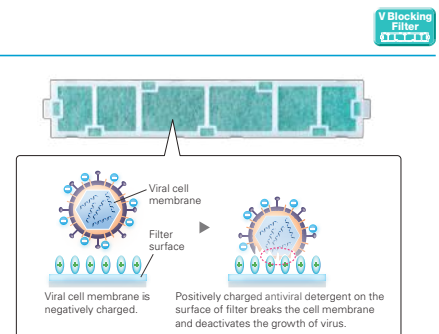

MSZ-BT SERIES



Indoor Unit

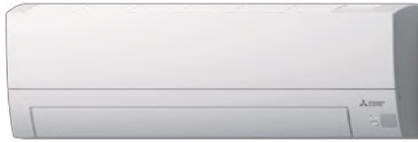

MSZ-BT20/25/35/50VG(K)

Outdoor Unit



MUZ-BT20VG



MUZ-BT25/35VG



MUZ-BT50VG

Remote Controller

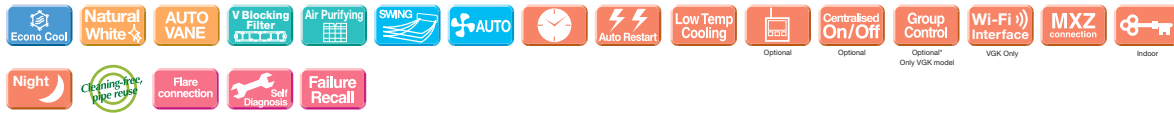

Type	Inverter Heat Pump						
Indoor Unit	MSZ-BT20VG(K)	MSZ-BT25VG(K)	MSZ-BT35VG(K)	MSZ-BT50VG(K)			
Outdoor Unit	MUZ-BT20VG	MUZ-BT25VG	MUZ-BT35VG	MUZ-BT50VG			
Refrigerant	R32 ⁽¹⁾						
Power Supply	Outdoor Power supply						
	Outdoor (V / Phase / Hz)						
				230V/Single/50Hz			
Cooling	Design load	kW	2.0	2.5	3.5	5.0	
	Annual electricity consumption ⁽²⁾	kWh/a	86	108	180	265	
	SEER ⁽⁴⁾		8.1	8.1	6.8	6.6	
	Energy efficiency class		A++	A++	A++	A++	
		Capacity	kW	2.0	2.5	3.5	5.0
	Min-Max	kW	0.5-2.9	0.5-3.0	0.9-3.5	1.3-5.0	
	Total Input	kW	0.450	0.700	1.240	2.050	
Heating (Average Season) ⁽⁵⁾	Design load	kW	1.5 (-10°C)	1.9 (-10°C)	2.4 (-10°C)	3.8 (-10°C)	
	Declared Capacity	at reference design temperature	kW	1.5 (-10°C)	1.9 (-10°C)	2.4 (-10°C)	3.8 (-10°C)
		at bivalent temperature	kW	1.5 (-10°C)	1.9 (-10°C)	2.4 (-10°C)	3.8 (-10°C)
		at operation limit temperature	kW	1.3 (-15°C)	1.7 (-15°C)	2.1 (-15°C)	3.4 (-15°C)
	Back up heating capacity	kW	0.0 (-10°C)	0.0 (-10°C)	0.0 (-10°C)	0.0 (-10°C)	
	Annual electricity consumption ⁽²⁾	kWh/a	487	577	727	1209	
	SCOP ⁽⁴⁾		4.3	4.6	4.6	4.4	
	Energy efficiency class		A+	A++	A++	A+	
		Capacity	kW	2.5	3.15	3.6	5.4
		Min-Max	kW	0.7-3.2	0.7-3.5	0.9-4.1	1.4-6.5
	Total Input	kW	0.550	0.750	0.930	1.550	
Operating Current (Max)	Input	A	5.6	7.0	7.0	10.0	
	Rated	kW	0.024	0.024	0.031	0.037	
	Operating Current(Max)	A	0.25	0.25	0.31	0.35	
	Dimensions	H*W*D	280-838-235	280-838-235	280-838-235	280-838-235	
Indoor Unit	Weight	kg	9	9	9	9	
	Air Volume (Lo-Mid-Hi-SH) ⁽³⁾	Cooling	m ³ /min	4.2 - 5.2 - 6.8 - 8.7 - 10.9	4.2 - 5.2 - 6.8 - 8.7 - 10.9	4.2 - 5.2 - 6.8 - 8.7 - 13.2	6.3 - 7.6 - 9.0 - 11.0 - 13.2
		Heating	m ³ /min	4.2 - 5.0 - 6.8 - 9.0 - 11.9	4.2 - 5.0 - 6.8 - 9.0 - 11.9	4.2 - 5.0 - 6.8 - 9.0 - 11.9	6.0 - 7.8 - 9.9 - 11.9 - 14.1
	Sound Level (SPL) (Lo-Mid-Hi-SH) ⁽³⁾	Cooling	dB(A)	19 - 22 - 30 - 37 - 43	19 - 22 - 30 - 37 - 43	19 - 22 - 31 - 38 - 46	29 - 33 - 36 - 40 - 46
		Heating	dB(A)	20 - 23 - 30 - 37 - 43	20 - 23 - 30 - 37 - 43	20 - 23 - 30 - 37 - 44	29 - 33 - 38 - 43 - 48
	Sound Level (PWL)	Cooling	dB(A)	57	57	60	60
	Dimensions	H*W*D	mm	538-699-249	538-699-249	538-699-249	550-800-285
Outdoor Unit	Weight	kg	23	24	24	35	
	Air Volume	Cooling	m ³ /min	30.3	32.2	32.2	30.4
		Heating	m ³ /min	30.3	32.2	34.6	32.7
	Sound Level (SPL)	Cooling	dB(A)	50	50	52	50
		Heating	dB(A)	50	50	52	51
	Sound Level (PWL)	Cooling	dB(A)	63	63	64	64
	Operating Current (Max)	A	5.3	6.7	6.7	9.6	
Breaker Size	A	10	10	10	12		
Ext. Piping	Diameter	Liquid/Gas	mm	6.35 / 9.52	6.35 / 9.52	6.35 / 12.7	
	Max.Length	Out-In	m	20	20	20	
	Max.Height	Out-In	m	12	12	12	
Guaranteed Operating Range (Outdoor)	Cooling	°C	-10 ~ +46	-10 ~ +46	-10 ~ +46	-10 ~ +46	
	Heating	°C	-15 ~ +24	-15 ~ +24	-15 ~ +24	-15 ~ +24	

(1) Refrigerant leakage contributes to climate change. Refrigerant with lower global warming potential (GWP) would contribute less to global warming than a refrigerant with higher GWP. If leaked to the atmosphere, this appliance contains a refrigerant fluid with a GWP equal to 550. This means that if 1 kg of this refrigerant fluid would be leaked to the atmosphere, the impact on global warming would be 550 times higher than 1 kg of CO₂ over a period of 100 years. Never try to interfere with the refrigerant circuit yourself or disassemble the product yourself and always ask a professional.

The GWP of R32 is 675 in the IPCC 4th Assessment Report.

(2) Energy consumption based on standard test results. Actual energy consumption will depend on how the appliance is used and where it is located.

(3) SH: Super High

(4) SEER, SCOP and other related description are based on COMMISSION DELEGATED REGULATION (EU) No.626/2011. The temperature conditions for calculating SCOP are based on "Average Season".

(5) Please see page 57-58 for heating (warmer season) specifications.

MSZ-HR SERIES

Compact, high-performance indoor and outdoor units with R32 that is low global warming potential compared with the current refrigerant R410A contribute to room comfort and to prevent global warming.

R32

MSZ-HR25/35/42/50VF(K)



MSZ-HR60/71VF(K)

“Rank A++/A+” Energy Savings Achieved for Entire Range of Series



All models in the series, from capacity 25 to 71, have achieved the “Rank A++” for SEER and “Rank A+” for SCOP as energy-savings rating, thanks to Mitsubishi Electric’s inverter technologies which are adopted to provide automatic adjustment of operation load according to need.

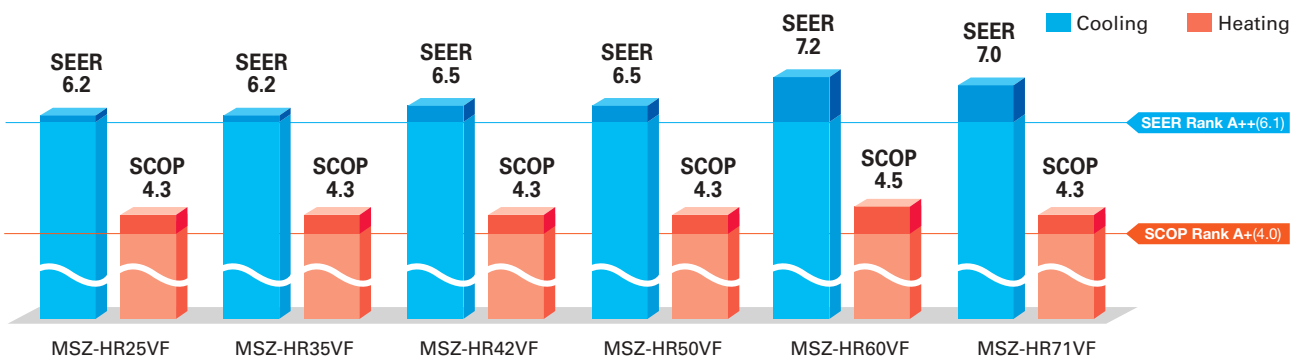

Simple and Friendly Design

The round front surface provides a simple and friendly impression. And the width of indoor unit is compact, making installation in smaller, tighter spaces possible.

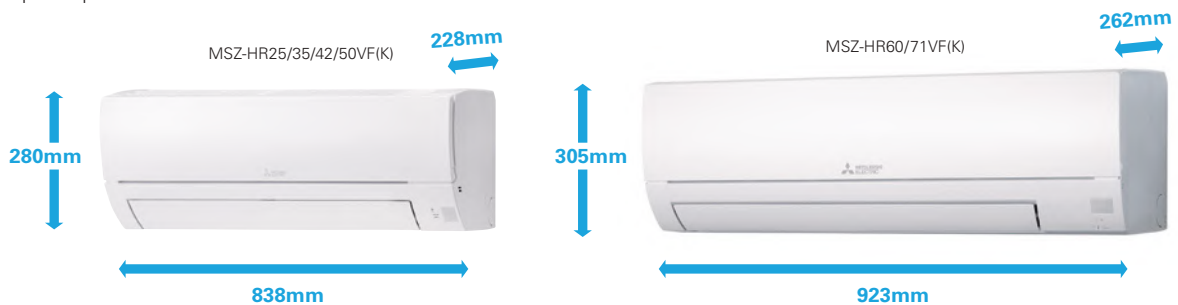

Wi-Fi and System Control

Wi-Fi Interface (Built-in) *Only VFK model

Built-in interface enabling users to control air conditioners and check operating status via devices such as personal computers, tablets and smartphones.

System Control Interface (Optional)

- Remote on/off operation is possible by input to the connector.
- Depending on the interface used, connecting a wired remote-control such as the PAR-41MAA is possible.
- Centralised control is possible when connected to M-NET.

*Wi-Fi Interface and System Control Interface cannot be used simultaneously.

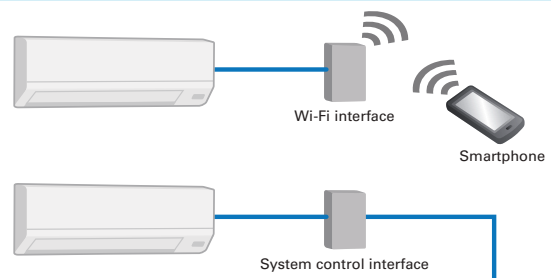

Air Purifying Filter



This filter generates stable antibacterial and deodorising effects. The size of the three-dimensional surface has been increased as well, enlarging the filter capture area. These features give the Air Purifying Filter better dust collection performance than conventional filters. The superior air-cleaning effectiveness raises room comfort yet another level.

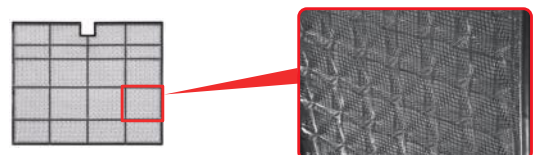

* It is okay to wash the filter with water (air-cleaning effect is maintained)

3D surface (Waved surface)

MSZ-HR SERIES



Indoor Unit R32



MSZ-HR25/35/42/50VF(K)



MSZ-HR60/71VF(K)

Outdoor Unit



MUZ-HR25VF



MUZ-HR35VF



MUZ-HR42/50VF



MUZ-HR60/71VF

Remote Controller

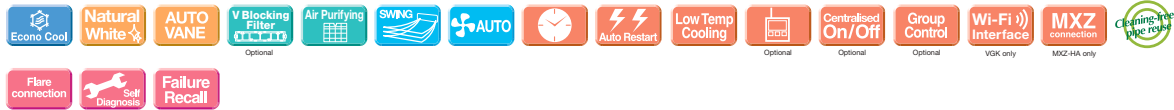

Type	Inverter Heat Pump									
Indoor Unit	MSZ-HR25VF(K)	MSZ-HR35VF(K)	MSZ-HR42VF(K)	MSZ-HR50VF(K)	MSZ-HR60VF(K)	MSZ-HR71VF(K)				
Outdoor Unit	MUZ-HR25VF	MUZ-HR35VF	MUZ-HR42VF	MUZ-HR50VF	MUZ-HR60VF	MUZ-HR71VF				
Refrigerant	R32 ⁽¹⁾									
Power Supply	Outdoor Power supply 230V/Single/50Hz									
Cooling	Design load	kW	2.5	3.4	4.2	5.0	6.1	7.1		
	Annual electricity consumption ⁽²⁾	kWh/a	141	191	226	269	296	355		
	SEER ⁽⁴⁾		6.2	6.2	6.5	6.5	7.2	7.0		
	Capacity	Rated	kW	2.5	3.4	4.2	5.0	6.1	7.1	
		Min-Max	kW	0.5-2.9	0.9-3.4	1.1-4.6	1.3-5.0	1.7-7.1	1.8-7.3	
Heating (Average Season) ⁽³⁾	Design load	kW	1.9 (-10°C)	2.4 (-10°C)	2.9 (-10°C)	3.8 (-10°C)	4.6 (-10°C)	5.4 (-10°C)		
	Declared Capacity	at reference design temperature	kW	1.9 (-10°C)	2.4 (-10°C)	2.9 (-10°C)	3.8 (-10°C)	4.6 (-10°C)	5.4 (-10°C)	
		at bivalent temperature	kW	1.9 (-10°C)	2.4 (-10°C)	2.9 (-10°C)	3.8 (-10°C)	4.6 (-10°C)	5.4 (-10°C)	
		at operation limit temperature	kW	1.9 (-10°C)	2.4 (-10°C)	2.9 (-10°C)	3.8 (-10°C)	4.6 (-10°C)	5.4 (-10°C)	
	Back up heating capacity	kW	0.0 (-10°C)	0.0 (-10°C)	0.0 (-10°C)	0.0 (-10°C)	0.0 (-10°C)	0.0 (-10°C)		
Annual electricity consumption ⁽²⁾	kWh/a	614	781	928	1224	1430	1755			
Capacity	Rated	kW	3.15	3.6	4.7	5.4	6.8	8.1		
	Min-Max	kW	0.7-3.5	0.9-3.7	0.9-5.4	1.4-6.5	1.5-8.5	1.5-9.0		
	Total Input	kW	0.850	0.975	1.300	1.550	1.810	2.440		
Operating Current (Max)	Input	A	5.0	6.7	8.5	10.0	14.1	14.1		
	Operating Current(Max)	A	0.020	0.028	0.032	0.039	0.055	0.055		
Indoor Unit	Dimensions	H*W*D	mm	280-838-228	280-838-228	280-838-228	280-838-228	305-923-262	305-923-262	
	Weight	kg		8.5	8.5	9	9	12.5	12.5	
	Air Volume (Lo-Mid-Hi-SH) ⁽³⁾	Cooling	m ³ /min		3.6 - 5.4 - 7.2 - 9.7	3.6 - 5.6 - 7.8 - 11.7	6.0 - 8.7 - 10.8 - 13.1	6.4 - 9.2 - 11.2 - 13.1	10.4 - 12.6 - 15.4 - 19.6	10.4 - 12.6 - 15.4 - 19.6
		Heating	m ³ /min		3.3 - 5.4 - 7.4 - 10.1	3.3 - 5.4 - 7.4 - 10.5	5.6 - 7.9 - 10.8 - 13.4	6.1 - 8.3 - 11.2 - 14.5	10.7 - 13.1 - 16.7 - 19.6	10.7 - 13.1 - 16.7 - 19.6
	Sound Level (SPL) (Lo-Mid-Hi-SH) ⁽³⁾	Cooling	dB(A)		21 - 30 - 37 - 43	22 - 31 - 38 - 46	24 - 34 - 39 - 45	28 - 36 - 40 - 45	33 - 38 - 44 - 50	33 - 38 - 44 - 50
Heating		dB(A)		21 - 30 - 37 - 43	21 - 30 - 37 - 44	24 - 32 - 40 - 46	27 - 34 - 41 - 47	33 - 38 - 44 - 50	33 - 38 - 44 - 50	
Outdoor Unit	Dimensions	H*W*D	mm	538-699-249	538-699-249	560-800-285	550-800-285	714-800-285	714-800-285	
	Weight	kg		23	22	32.5	34	40	40	
	Air Volume	Cooling	m ³ /min		30.3	32.2	30.4	30.4	42.8	42.8
		Heating	m ³ /min		30.3	32.2	32.7	32.7	48.3	48.3
	Sound Level (SPL)	Cooling	dB(A)		50	51	50	50	53	53
Heating		dB(A)		50	51	51	51	57	57	
Operating Current (Max)	Cooling	A		4.8	6.4	8.2	9.6	13.6	13.6	
	Heating	A		4.8	6.4	8.2	9.6	13.6	13.6	
Ext. Piping	Diameter	Liquid/Gas	mm	6.35 / 9.52	6.35 / 9.52	6.35 / 9.52	6.35 / 9.52	6.35 / 12.7	6.35 / 12.7	
	Max.Length	Out-In	m	20	20	20	20	30	30	
	Max.Height	Out-In	m	12	12	12	12	15	15	
Guaranteed Operating Range (Outdoor)	Cooling	°C		-10 ~ +46	-10 ~ +46	-10 ~ +46	-10 ~ +46	-10 ~ +46	-10 ~ +46	
	Heating	°C		-10 ~ +24	-10 ~ +24	-10 ~ +24	-10 ~ +24	-10 ~ +24	-10 ~ +24	

(1) Refrigerant leakage contributes to climate change. Refrigerant with lower global warming potential (GWP) would contribute less to global warming than a refrigerant with higher GWP, if leaked to the atmosphere. This appliance contains a refrigerant fluid with a GWP equal to 550. This means that if 1 kg of this refrigerant fluid would be leaked to the atmosphere, the impact on global warming would be 550 times higher than 1 kg of CO₂ over a period of 100 years. Never try to interfere with the refrigerant circuit yourself or disassemble the product yourself and always ask a professional.

The GWP of R32 is 675 in the IPCC 4th Assessment Report.

(2) Energy consumption based on standard test results. Actual energy consumption will depend on how the appliance is used and where it is located.

(3) SH: Super High

(4) SEER, SCOP and other related description are based on COMMISSION DELEGATED REGULATION (EU) No.626/2011. The temperature conditions for calculating SCOP are based on "Average Season".

(5) Please see page 57-59 for description (warmer season) specifications.

MSZ-DW SERIES

R32

Introducing an indoor unit that is compact yet packed with a variety of features.

High energy saving performance and Air Purifying Filter bring you a comfortable indoor environment.

MSZ-DW25/35/50VF



Energy Saving



Mitsubishi Electric's inverter technologies are adopted to provide automatic adjustment of operation load according to need. This reduces excessive consumption of electricity, and thereby realises Energy Rank "A++" for SEER (cooling) and "A+" for SCOP (heating).

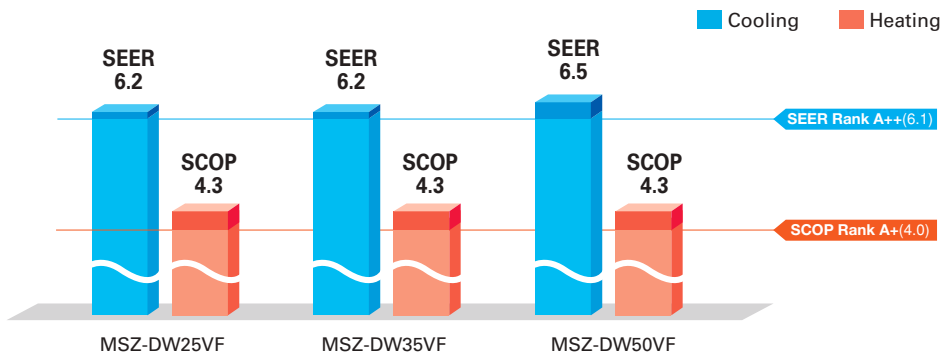

Simple and Compact Design

The stylish design makes it a natural match for any room. The width of indoor units is compact, making installation in smaller, tighter spaces possible.



Simple Control

The simple remote controller and functions provide the easy control solution and comforts of life.



Air Purifying Filter



Air Purifying Filter generates stable antibacterial, antifungal, and deodorant effects. The three-dimensional surface expands the filter's capture area and contributes to the better dust collection performance than conventional filters.



Wi-Fi and System Control

Wi-Fi Interface (Optional)

Optional interface and a Cloud-based solution "MELCloud" enable users to control air conditioners and check operating status via devices such as laptops, tablets and smartphones.

System Control Interface (Optional)

- Remote on/off operation is possible by input to the connector.
- Depending on the interface used, connecting a wired remote control such as the PAR-41MAA is possible.
- Centralised control is possible when connected to M-NET.

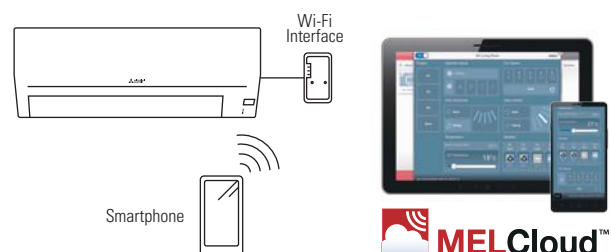

MSZ-DW SERIES



Indoor Unit R32



MSZ-DW25/35/50VF

Outdoor Unit



MUZ-DW25VF



MUZ-DW35VF



MUZ-DW50VF

Remote Controller

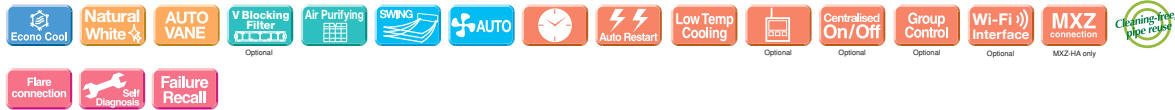

Type	Inverter Heat Pump					
Indoor Unit	MSZ-DW25VF	MSZ-DW35VF	MSZ-DW50VF			
Outdoor Unit	MUZ-DW25VF	MUZ-DW35VF	MUZ-DW50VF			
Refrigerant	R32 ⁽¹⁾					
Power Supply	Outdoor Power supply 230V/Single/50Hz					
Cooling	Design load	kW	2.5	3.4	5.0	
	Annual electricity consumption ⁽²⁾	kWh/a	135	184	261	
	SEER ⁽⁴⁾		6.2	6.2	6.5	
	Energy efficiency class			A++	A++	A++
	Capacity		kW	2.5	3.4	5.0
Heating (Average Season) ⁽⁵⁾	Design load	kW	1.9 (-10°C)	2.4 (-10°C)	3.8 (-10°C)	
	Declared Capacity		kW	1.9 (-10°C)	2.4 (-10°C)	3.8 (-10°C)
	Back up heating capacity		kW	1.9 (-10°C)	2.4 (-10°C)	3.8 (-10°C)
	Annual electricity consumption ⁽²⁾	kWh/a	618	781	1174	
	SCOP ⁽⁴⁾		4.3	4.3	4.3	
Operating Current (Max)	Energy efficiency class			A+	A+	
	Capacity		kW	3.15	3.6	5.4
	Total Input		kW	0.7-3.5	0.9-3.7	1.4-6.5
	Operating Current (Max)		A	0.850	0.975	1.550
	Input		kW	0.023	0.028	0.029
Indoor Unit	Operating Current (Max)		A	0.24	0.29	
	Dimensions	H*W*D	mm	290-799-232	290-799-232	290-799-232
	Weight		kg	9	9	10
	Air Volume (Lo-Mid-Hi-SH)⁽³⁾	Cooling	m ³ /min	3.6 - 5.6 - 7.5 - 9.9	3.6 - 5.8 - 8.1 - 11.3	5.9 - 7.7 - 9.7 - 12.3
	Sound Level (SPL) (Lo-Mid-Hi-SH)⁽³⁾	Heating	m ³ /min	3.4 - 5.6 - 7.7 - 10.3	3.4 - 5.6 - 7.7 - 10.7	6.0 - 7.7 - 9.7 - 12.6
Outdoor Unit	Sound Level (SPL)	Cooling	dB(A)	21 - 30 - 37 - 43	22 - 31 - 38 - 46	28 - 36 - 40 - 45
	Sound Level (PWL)	Heating	dB(A)	21 - 30 - 37 - 43	21 - 30 - 37 - 44	27 - 34 - 41 - 47
	Sound Level (PWL)	Cooling	dB(A)	57	60	60
	Dimensions	H*W*D	mm	538-699-249	538-699-249	550-800-285
	Weight		kg	23	24	35
Ext. Piping	Air Volume	Cooling	m ³ /min	30.3	32.2	33.5
	Sound Level (SPL)	Heating	m ³ /min	30.3	32.2	32.7
	Sound Level (SPL)	Cooling	dB(A)	50	51	50
	Sound Level (PWL)	Heating	dB(A)	50	51	51
	Sound Level (PWL)	Cooling	dB(A)	63	64	64
Guaranteed Operating Range (Outdoor)	Operating Current (Max)		A	5.3	7.0	9.2
	Breaker Size		A	10	10	12
	Diameter	Liquid/Gas	mm	6.35 / 9.52	6.35 / 9.52	6.35 / 9.52
	Max.Length	Out-In	m	20	20	20
	Max.Height	Out-In	m	12	12	12
Guaranteed Operating Range (Outdoor)	Guaranteed Operating Range	Cooling	°C	-10 ~ +46	-10 ~ +46	-10 ~ +46
	Guaranteed Operating Range	Heating	°C	-10 ~ +24	-10 ~ +24	-10 ~ +24

(1) Refrigerant leakage contributes to climate change. Refrigerant with lower global warming potential (GWP) would contribute less to global warming than a refrigerant with higher GWP. If leaked to the atmosphere, this appliance contains a refrigerant fluid with a GWP equal to 550. This means that if 1 kg of this refrigerant fluid would be leaked to the atmosphere, the impact on global warming would be 550 times higher than 1 kg of CO₂ over a period of 100 years. Never try to interfere with the refrigerant circuit yourself or disassemble the product yourself and always ask a professional.

The GWP of R32 is 675 in the IPCC 4th Assessment Report.

(2) Energy consumption based on standard test results. Actual energy consumption will depend on how the appliance is used and where it is located.

(3) SH: Super High

(4) SEER, SCOP and other related description are based on COMMISSION DELEGATED REGULATION (EU) No.626/2011. The temperature conditions for calculating SCOP are based on "Average Season".

(5) Please see page 57-59 for heating (warmer season) specifications.

MSY-TP SERIES

R32

MSY-TP35/50VF



Cooling only model with high-performance provides high SHF in various environments thanks to wide operation range.

High Energy-Saving Performance with High SHF

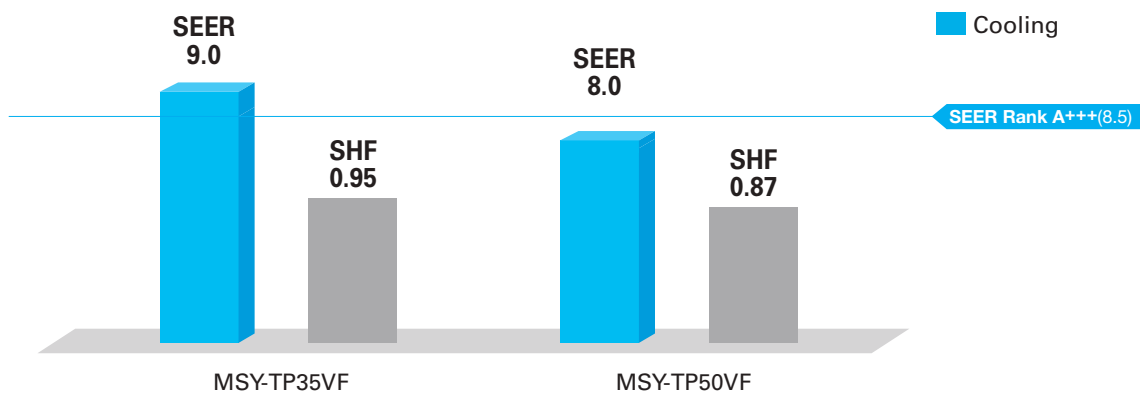

Wide Cooling Operating Range

As a result of an extended operating range in cooling, these models accommodate a wide range of usage environments and applications.

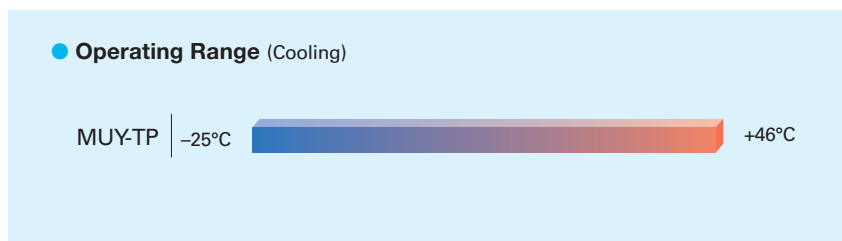

MSY-TP SERIES



Indoor Unit R32



MSY-TP35/50VF

Outdoor Unit R32



MUY-TP35/TP50VF

Remote Controller

- Wired remote controller can be connected to indoor unit.

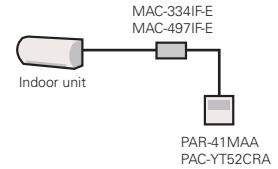

Type		Inverter Heat Pump			
Indoor Unit		MSY-TP35VF		MSY-TP50VF	
Outdoor Unit		MUY-TP35VF		MUY-TP50VF	
Refrigerant		R32 ⁽¹⁾			
Power Supply		Indoor Power supply			
Source		230V / Single / 50Hz			
Outdoor (V / Phase / Hz)					
Cooling	Design load	kW	3.5	5.0	
	Annual electricity consumption ⁽²⁾	kWh/a	136	218	
	SEER ⁽⁴⁾		9.0	8.0	
	Capacity	Energy efficiency class		A+++	A++
		Rated	kW	3.5	5.0
	Total Input	Min-Max	kW	1.5 - 4.0	1.5 - 5.7
Rated		kW	0.760	1.450	
Heating (Average Season) ⁽³⁾	Design load	kW	-	-	
	Declared Capacity	at reference design temperature	kW	-	-
		at bivalent temperature	kW	-	-
		at operation limit temperature	kW	-	-
	Back up heating capacity	kW	-	-	
	Annual electricity consumption ⁽²⁾	kWh/a	-	-	
	SCOP ⁽⁴⁾		-	-	
	Capacity	Energy efficiency class		-	-
Rated		kW	-	-	
Total Input	Min-Max	kW	-	-	
	Rated	kW	-	-	
Operating Current (Max)		A	9.6	9.6	
Indoor Unit	Input	Rated	kW	0.033	0.034
		Operating Current (Max)	A	0.4	0.4
	Dimensions	H*W*D	mm	305-923-250	305-923-250
	Weight		kg	12.5	12.5
	Air Volume (Lo-Mid-Hi-SH) ⁽³⁾	Cooling	m ³ /min	10.1 - 11.6 - 13.7 - 16.4	10.1 - 11.6 - 13.7 - 16.4
		Heating	m ³ /min	-	-
	Sound Level (SPL) (Lo-Mid-Hi-SH) ⁽³⁾	Cooling	dB(A)	31 - 36 - 40 - 45	31 - 36 - 40 - 45
		Heating	dB(A)	-	-
	Sound Level (PWL)	Cooling	dB(A)	60	60
		Heating	dB(A)	10	10
	Breaker Size	A		10	10
	Outdoor Unit	Dimensions	H*W*D	mm	550-800-285
Weight			kg	34	34
Air Volume		Cooling	m ³ /min	29.3	29.3
		Heating	m ³ /min	-	-
Sound Level (SPL)		Cooling	dB(A)	45	47
		Heating	dB(A)	-	-
Sound Level (PWL)		Cooling	dB(A)	58	61
		Heating	dB(A)	9.2	9.2
Ext. Piping	Diameter	Liquid/Gas	mm	6.35/9.52	6.35/9.52
	Max.Length	Out-In	m	20	20
	Max.Height	Out-In	m	12	12
Guaranteed Operating Range (Outdoor)	Cooling	°C	-25 - +46	-25 - +46	
	Heating	°C	-	-	

(1) Refrigerant leakage contributes to climate change. Refrigerant with lower global warming potential (GWP) would contribute less to global warming than a refrigerant with higher GWP, if leaked to the atmosphere. This appliance contains a refrigerant fluid with a GWP equal to 550. This means that if 1 kg of this refrigerant fluid would be leaked to the atmosphere, the impact on global warming would be 550 times higher than 1 kg of CO₂ over a period of 100 years. Never try to interfere with the refrigerant circuit yourself or disassemble the product yourself and always ask a professional.

The GWP of R32 is 675 in the IPCC 4th Assessment Report.

(2) Energy consumption based on standard test results. Actual energy consumption will depend on how the appliance is used and where it is located.

(3) SHi: Super High

(4) SEER and other related description are based on COMMISSION DELEGATED REGULATION (EU) No.626/2011.

MSZ-S SERIES

MSZ-G SERIES

Introducing a compact and stylish indoor unit with amazingly quiet performance. Not only are neat installations in small bedrooms possible, increase energy-savings by selecting the optimal capacity required for each room.



“Rank A+/A+” Energy Savings Achieved for Entire Range of Series



All models in the series, from the low-capacity 25 to the high-capacity 71, have achieved the “Rank A+” for SEER and “Rank A+” for SCOP as energy-savings rating. For home use, such as in bedrooms and living rooms, to light commercial use, such as in offices, our air conditioners are contributing to reduced energy consumption in a wide range.

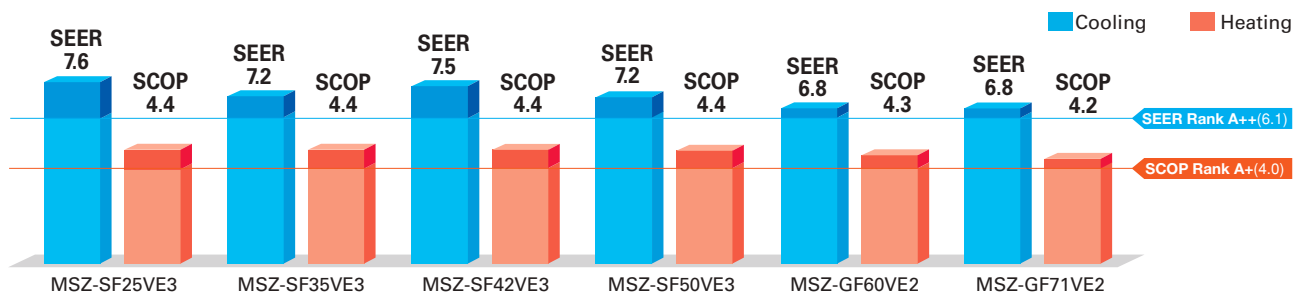

Wide Line-up

Eight different indoor units (Model 15-71) are available to meet your diversified air conditioning needs.



Compact and Stylish

(MSZ-SF15/20VA)

The stylish, square indoor unit adds a touch of class to any room interior. The compact design is 64mm thinner than our previous indoor unit with the lowest output capacity (MSZ-GE22VA).

Comparison with our previous model GE



Family Design

(MSZ-SF15/20/25/35/42/50)

Models in the 25-50 class are introduced as single-split units while retaining the popular design of the SF15/20VA* as indoor units exclusively for multi-systems. From small rooms to living rooms, it is possible to coordinate residences with a unified design.

*Size may vary.

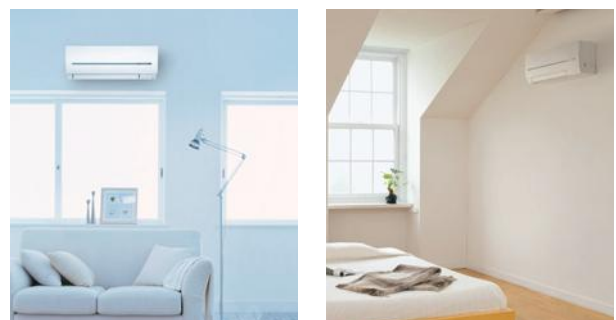

“Weekly Timer”



Easily set desired temperatures and operation start/stop times to match lifestyle patterns. Reduce wasted energy consumption by using the timer to prevent forgetting to turn off the unit and eliminate temperature setting adjustments.

■ Example Operation Pattern (Winter/Heating mode)

	Mon.	Tues.	Wed.	Thurs.	Fri.	Sat.	Sun.
6:00	ON 20°C	ON 20°C	ON 20°C	ON 20°C	ON 20°C	ON 20°C	ON 20°C
8:00	Automatically changes to high-power operation at wake-up time						
10:00	OFF	OFF	OFF	OFF	OFF	ON 18°C	ON 18°C
12:00	Automatically turned off during work hours					Midday is warmer, so the temperature is set lower	
14:00							
16:00							
18:00	ON 20°C	ON 20°C	ON 20°C	ON 20°C	ON 20°C	ON 20°C	ON 20°C
20:00	Automatically turns on, synchronized with arrival at home					Automatically raises temperature setting to match time when outside-air temperature is low	
22:00 (during sleeping hours)	ON 18°C	ON 18°C	ON 18°C	ON 18°C	ON 18°C	ON 18°C	ON 18°C
	Automatically lowers temperature at bedtime for energy-saving operation at night						

Settings **Pattern Settings:** Input up to four settings for each day
Settings: • Start/Stop operation • Temperature setting *The operation mode cannot be set.

■ Easy set-up using dedicated buttons



The remote controller is equipped with buttons that are used exclusively for setting the Weekly Timer. Setting operation patterns is easy and quick.

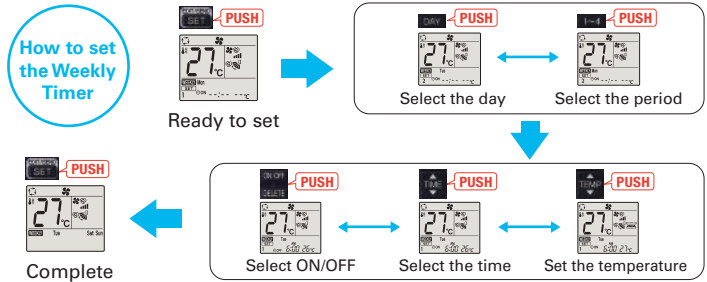

- Start by pushing the “SET” button and follow the instructions to set the desired patterns. Once all of the desired patterns are input, point the top end of the remote controller at the indoor unit and push the “SET” button one more time. (Push the “SET” button only after inputting all of the desired patterns into the remote controller memory. Pushing the “CANCEL” button will end the set-up process without sending the operation patterns to the indoor unit).
- It takes a few seconds to transmit the Weekly Timer operation patterns to the indoor unit. Please continue to point the remote controller at the indoor unit until all data has been sent.
- When “Weekly Timer” is set, temperature can not be set 10°C.

Low Standby Power

Electrical devices consume standby power even when they are not in actual use. While we obviously strive to reduce power consumption during actual use, reducing this wasted power that cannot be seen is also very important.

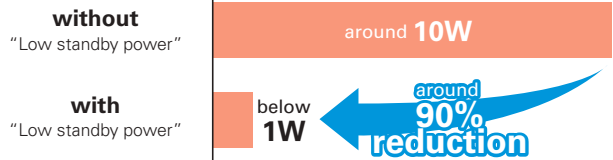

Air Purifying Filter (MSZ-SF25/35/42/50, MSZ-GF60/71)

This filter generates stable antibacterial and deodorising effects. The size of the three-dimensional surface has been increased as well, enlarging the filter capture area. These features give the Air Purifying Filter better dust collection performance than conventional filters. The superior air-cleaning effectiveness raises room comfort yet another level.

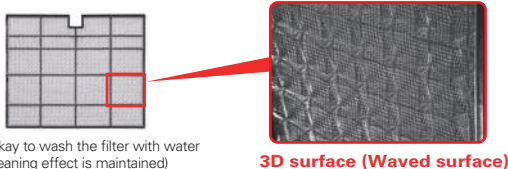

* It is okay to wash the filter with water (air-cleaning effect is maintained)

3D surface (Waved surface)

“i save” Mode



“i save” is a simplified setting function that recalls the preferred (pre-set) temperature by pressing a single button on the remote controller. Press the same button twice in repetition to immediately return to the previous temperature setting. Using this function contributes to comfortable, waste-free operation, realising the most suitable air conditioning settings and saving on power consumption when, for example, leaving the room or going to bed.

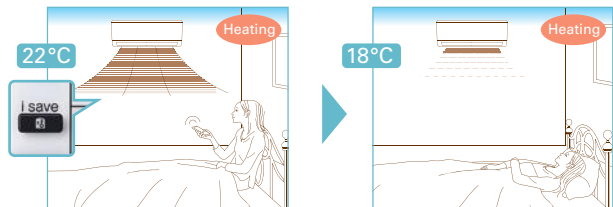

* Temperature can be preset to 10°C when heating in the “i-save” mode.

Outdoor Units for Cold Region (25/35/42/50)

Single split-type outdoor units are available in both standard and heater-equipped units. An electric heater is installed in each unit to prevent freezing in cold outdoor environments.



MSZ-S SERIES



Indoor Unit

R410A



MSZ-SF15/20VA



Outdoor Unit

For Multi Connection Only

Remote Controller



Type	Inverter Heat Pump										
Indoor Unit	MSZ-SF15VA		MSZ-SF20VA		MSZ-SF25VE3		MSZ-SF35VE3		MSZ-SF35VE3		
Outdoor Unit	for MXZ connection				MUZ-SF25VE		MUZ-SF25VEH		MUZ-SF35VE		
Refrigerant	R410A ⁽¹⁾										
Power Source	Outdoor Power supply										
Supply	Outdoor (V / Phase / Hz)										
Cooling	Design load	kW	-	-	2.5	2.5	3.5	3.5	3.5	3.5	
	Annual electricity consumption ⁽²⁾	kWh/a	-	-	116	116	171	171	171	171	
	SEER ⁽³⁾		-	-	7.6	7.6	7.2	7.2	7.2	7.2	
	Energy efficiency class			-	-	A++	A++	A++	A++	A++	A++
		Rated	kW	-	-	2.5	2.5	3.5	3.5	3.5	3.5
	Capacity	Min-Max	kW	-	-	0.9-3.4	0.9-3.4	1.1-3.8	1.1-3.8	1.1-3.8	1.1-3.8
Total Input	Rated	kW	-	-	0.600	0.600	1.080	1.080	1.080	1.080	
Heating (Average Season) ⁽⁴⁾	Design load	kW	-	-	2.4(-10°C)	2.4(-10°C)	2.9(-10°C)	2.9(-10°C)	2.9(-10°C)	2.9(-10°C)	
	Declared Capacity	at reference design temperature	kW	-	-	2.4(-10°C)	2.4(-10°C)	2.9(-10°C)	2.9(-10°C)	2.9(-10°C)	2.9(-10°C)
		at bivalent temperature	kW	-	-	2.4(-10°C)	2.4(-10°C)	2.9(-10°C)	2.9(-10°C)	2.9(-10°C)	2.9(-10°C)
		at operation limit temperature	kW	-	-	2.0(-15°C)	1.6(-20°C)	2.2(-15°C)	1.6(-20°C)	1.6(-20°C)	1.6(-20°C)
	Back up heating capacity	kW	-	-	0.0(-10°C)	0.0(-10°C)	0.0(-10°C)	0.0(-10°C)	0.0(-10°C)	0.0(-10°C)	
	Annual electricity consumption ⁽²⁾	kWh/a	-	-	764	790	923	948	948	948	
SCOP ⁽⁴⁾			-	-	4.4	4.3	4.4	4.4	4.3	4.3	
	Energy efficiency class		-	-	A+	A+	A+	A+	A+	A+	
Capacity	Rated	kW	-	-	3.2	3.2	4.0	4.0	4.0	4.0	
	Min-Max	kW	-	-	1.0-4.1	1.0-4.1	1.3-4.6	1.3-4.6	1.3-4.6	1.3-4.6	
Total Input	Rated	kW	-	-	0.780	0.780	1.030	1.030	1.030	1.030	
Operating Current (Max)		A	-	-	8.4	8.4	8.5	8.5	8.5	8.5	
Indoor Unit	Input	Rated	kW	0.017	0.019	0.024	0.024	0.027	0.027	0.027	
		Operating Current(Max)	A	0.17	0.19	0.2	0.2	0.3	0.3	0.3	
	Dimensions	H*W*D	mm	250-760-168	250-760-168	299-798-195	299-798-195	299-798-195	299-798-195	299-798-195	
	Weight	kg	7.7	7.7	10	10	10	10	10	10	
	Air Volume (SLo-Lo-Mid-Hi-SH) ⁽⁵⁾	Cooling	m ³ /min	3.5 - 3.9 - 4.6 - 5.5 - 6.4	3.5 - 3.9 - 4.6 - 5.5 - 6.9	3.2 - 4.1 - 5.6 - 7.2 - 9.1	3.2 - 4.1 - 5.6 - 7.2 - 9.1	3.2 - 4.1 - 5.6 - 7.2 - 9.1	3.2 - 4.1 - 5.6 - 7.2 - 9.1	3.2 - 4.1 - 5.6 - 7.2 - 9.1	
		Heating	m ³ /min	3.7 - 4.4 - 5.0 - 6.0 - 6.8	3.7 - 4.4 - 5.0 - 6.0 - 7.3	3.0 - 4.1 - 6.7 - 8.2 - 10.3	3.0 - 4.1 - 6.7 - 8.2 - 10.3	3.0 - 4.1 - 6.7 - 8.3 - 11.0	3.0 - 4.1 - 6.7 - 8.3 - 11.0	3.0 - 4.1 - 6.7 - 8.3 - 11.0	
Sound Level (SPL) (SLo-Lo-Mid-Hi-SH) ⁽⁵⁾	Cooling	dB(A)	21 - 26 - 30 - 35 - 40	21 - 26 - 30 - 35 - 42	19 ⁽⁶⁾ - 24 - 30 - 36 - 42	19 ⁽⁶⁾ - 24 - 30 - 36 - 42	19 ⁽⁶⁾ - 24 - 30 - 36 - 42	19 ⁽⁶⁾ - 24 - 30 - 36 - 42	19 ⁽⁶⁾ - 24 - 30 - 36 - 42		
	Heating	dB(A)	21 - 26 - 30 - 35 - 40	21 - 26 - 30 - 35 - 42	19 ⁽⁶⁾ - 24 - 34 - 39 - 45	19 ⁽⁶⁾ - 24 - 34 - 39 - 45	19 ⁽⁶⁾ - 24 - 34 - 40 - 46	19 ⁽⁶⁾ - 24 - 34 - 40 - 46	19 ⁽⁶⁾ - 24 - 34 - 40 - 46		
Sound Level (PWL)	Cooling	dB(A)	59	60	57	57	57	57	57		
Dimensions	H*W*D	mm	-	-	550-800-285	550-800-285	550-800-285	550-800-285	550-800-285		
Weight	kg	-	-	-	31	31	31	31	31		
Outdoor Unit	Air Volume	Cooling	m ³ /min	-	-	31.1	31.1	35.9	35.9	35.9	
		Heating	m ³ /min	-	-	30.7	30.7	35.9	35.9	35.9	
	Sound Level (SPL)	Cooling	dB(A)	-	-	47	47	49	49	49	
		Heating	dB(A)	-	-	48	48	50	50	50	
	Sound Level (PWL)	Cooling	dB(A)	-	-	58	58	62	62	62	
		Heating	dB(A)	-	-	58	58	62	62	62	
Operating Current (Max)	A	-	-	8.2	8.2	8.2	8.2	8.2			
Breaker Size	A	-	-	10	10	10	10	10			
Ext. Piping	Diameter	Liquid/Gas	mm	6.35/9.52	6.35/9.52	6.35 / 9.52	6.35 / 9.52	6.35 / 9.52	6.35 / 9.52		
	Max.Length	Out-In	m	-	-	20	20	20	20		
	Max.Height	Out-In	m	-	-	12	12	12	12		
Guaranteed Operating Range (Outdoor)	Cooling	°C	-	-	-10 ~ +46	-10 ~ +46	-10 ~ +46	-10 ~ +46	-10 ~ +46		
	Heating	°C	-	-	-15 ~ +24	-20 ~ +24	-15 ~ +24	-15 ~ +24	-20 ~ +24		

(1) Refrigerant leakage contributes to climate change. Refrigerant with lower global warming potential (GWP) would contribute less to global warming than a refrigerant with higher GWP, if leaked to the atmosphere. This appliance contains a refrigerant fluid with a GWP equal to 1975. This means that if 1 kg of this refrigerant fluid would be leaked to the atmosphere, the impact on global warming would be 1975 times higher than 1 kg of CO₂ over a period of 100 years. Never try to interfere with the refrigerant circuit yourself or disassemble the product yourself and always ask a professional.

The GWP of R410A is 2088 in the IPCC 4th Assessment Report.

(2) Energy consumption based on standard test results. Actual energy consumption will depend on how the appliance is used and where it is located.

(3) SH: Super High

(4) SEER, SCOP and other related description are based on COMMISSION DELEGATED REGULATION (EU) No.626/2011. The temperature conditions for calculating SCOP are based on "Average Season".

(5) Please see page 57-59 for heating (warmer season) specifications.

(6) For single use: only 19dB(A). For multi use (MXZ): 21dB(A).

MSZ-S SERIES MSZ-G SERIES



Indoor Unit

R410A



MSZ-SF25/35/42/50VE3



MSZ-GF60/71VE2

Outdoor Unit

R410A



MUZ-SF25/35/42VE(H)



MUZ-SF50VE(H)
MUZ-GF60/71VE

Remote Controller



Type	Inverter Heat Pump								
Indoor Unit	MSZ-SF42VE3	MSZ-SF42VE3	MSZ-SF50VE3	MSZ-SF50VE3	MSZ-GF60VE2	MSZ-GF71VE2			
Outdoor Unit	MUZ-SF42VE	MUZ-SF42VEH	MUZ-SF50VE	MUZ-SF50VEH	MUZ-SF60VE	MUZ-SF60VE	MUZ-GF71VE		
Refrigerant	R410A ⁽¹⁾								
Power Source	Outdoor Power supply								
Supply	230/Single/50								
Cooling	Design load	kW	4.2	4.2	5.0	5.0	6.1	7.1	
	Annual electricity consumption ⁽²⁾	kWh/a	196	196	246	246	311	364	
	SEER ⁽³⁾		7.5	7.5	7.2	7.2	6.8	6.8	
	Energy efficiency class		A++	A++	A++	A++	A++	A++	
		Capacity	kW	4.2	4.2	5.0	5.0	6.1	7.1
Heating (Average Season) ⁽⁴⁾	Design load	kW	3.8 (-10°C)	3.8 (-10°C)	4.2 (-10°C)	4.2 (-10°C)	4.6 (-10°C)	6.7 (-10°C)	
	Declared Capacity	at reference design temperature	kW	3.8 (-10°C)	3.8 (-10°C)	4.2 (-10°C)	4.2 (-10°C)	4.6 (-10°C)	6.7 (-10°C)
		at bivalent temperature	kW	3.8 (-10°C)	3.8 (-10°C)	4.2 (-10°C)	4.2 (-10°C)	4.6 (-10°C)	6.7 (-10°C)
		at operation limit temperature	kW	3.4 (-15°C)	3.2 (-20°C)	3.4 (-15°C)	2.3 (-20°C)	3.7 (-15°C)	5.4 (-15°C)
	Back up heating capacity	kW	0.0 (-10°C)	0.0 (-10°C)	0.0 (-10°C)	0.0 (-10°C)	0.0 (-10°C)	0.0 (-10°C)	
SCOP ⁽⁵⁾	Annual electricity consumption ⁽²⁾	kWh/a	1215	1242	1351	1380	1489	2204	
	SCOP ⁽⁵⁾		4.4	4.3	4.4	4.3	4.3	4.2	
	Energy efficiency class		A+	A+	A+	A+	A+	A+	
		Capacity	kW	5.4	5.4	5.8	5.8	6.8	8.1
	Total Input	Min-Max	kW	1.3-6.0	1.3-6.0	1.4-7.3	1.4-7.3	2.0-9.3	2.2-9.9
Rated		kW	1.580	1.580	1.700	1.700	1.810	2.230	
Operating Current (Max)	Input	A	9.5	9.5	12.3	12.3	14.5	16.6	
	Operating Current(Max)	A	0.3	0.3	0.3	0.3	0.5	0.5	
Indoor Unit	Dimensions	H*W*D	mm	299-798-195	299-798-195	299-798-195	299-798-195	325-1100-238	325-1100-238
	Weight		kg	10	10	10	10	16	16
	Air Volume (SLo-Lo-Mid-Hi-SH) ⁽⁶⁾	Cooling	m ³ /min	4.7 - 5.8 - 6.7 - 7.9 - 9.1	4.7 - 5.8 - 6.7 - 7.9 - 9.1	5.1 - 6.2 - 7.0 - 8.2 - 9.9	5.1 - 6.2 - 7.0 - 8.2 - 9.9	9.8-11.3-13.4-15.6-18.3	9.7-11.5-13.3-15.4-17.8
		Heating	m ³ /min	4.7 - 5.8 - 7.2 - 9.1 - 11.4	4.7 - 5.8 - 7.2 - 9.1 - 11.4	5.1 - 6.4 - 8.0 - 9.8 - 12.0	5.1 - 6.4 - 8.0 - 9.8 - 12.0	9.8-11.3-13.4-15.6-18.3	10.2-11.5-13.3-15.4-17.8
	Sound Level (SPL) (SLo-Lo-Mid-Hi-SH) ⁽⁶⁾	Cooling	dB(A)	26 ⁽⁶⁾ - 31 - 34 - 38 - 42	26 ⁽⁶⁾ - 31 - 34 - 38 - 42	28 ⁽⁷⁾ - 33 - 36 - 40 - 45	28 ⁽⁷⁾ - 33 - 36 - 40 - 45	29 - 37 - 41 - 45 - 49	30 - 37 - 41 - 45 - 49
		Heating	dB(A)	26 ⁽⁶⁾ - 31 - 36 - 42 - 47	26 ⁽⁶⁾ - 31 - 36 - 42 - 47	28 ⁽⁷⁾ - 33 - 38 - 43 - 49	28 ⁽⁷⁾ - 33 - 38 - 43 - 49	29 - 37 - 41 - 45 - 49	30 - 37 - 41 - 45 - 49
	Sound Level (PWL)	Cooling	dB(A)	57	57	58	58	65	65
		Heating	dB(A)	57	57	58	58	65	65
	Dimensions	H*W*D	mm	550-800-285	550-800-285	880-840-330	880-840-330	880-840-330	880-840-330
	Weight		kg	35	35	55	55	50	53
Outdoor Unit	Air Volume	Cooling	m ³ /min	35.2	35.2	44.6	44.6	49.2	50.1
		Heating	m ³ /min	33.6	33.6	44.6	44.6	49.2	48.2
	Sound Level (SPL)	Cooling	dB(A)	50	50	52	52	55	55
		Heating	dB(A)	51	51	52	52	55	55
	Sound Level (PWL)	Cooling	dB(A)	63	63	65	65	65	65
Heating		dB(A)	63	63	65	65	65	65	
Ext. Piping	Operating Current (Max)	A	9.2	9.2	12	12	14	16.1	
	Breaker Size	A	10	10	16	16	20	20	
	Diameter	Liquid/Gas	mm	6.35 / 9.52	6.35 / 9.52	6.35 / 12.7	6.35 / 12.7	6.35/15.88	9.52/15.88
Guaranteed Operating Range (Outdoor)	Max.Length	Out-In	m	20	20	30	30	30	
	Max.Height	Out-In	m	12	12	15	15	15	
	Max.Length	Out-In	m	20	20	30	30	30	
Guaranteed Operating Range (Outdoor)	Cooling	°C	-10 ~ +46	-10 ~ +46	-10 ~ +46	-10 ~ +46	-10 ~ +46	-10 ~ +46	
	Heating	°C	-15 ~ +24	-20 ~ +24	-15 ~ +24	-20 ~ +24	-15 ~ +24	-15 ~ +24	

(1) Refrigerant leakage contributes to climate change. Refrigerant with lower global warming potential (GWP) would contribute less to global warming than a refrigerant with higher GWP, if leaked to the atmosphere. This appliance contains a refrigerant fluid with a GWP equal to 1975. This means that if 1 kg of this refrigerant fluid would be leaked to the atmosphere, the impact on global warming would be 1975 times higher than 1 kg of CO₂ over a period of 100 years. Never try to interfere with the refrigerant circuit yourself or disassemble the product yourself and always ask a professional.

The GWP of R410A is 2088 in the IPCC 4th Assessment Report.

(2) Energy consumption based on standard test results. Actual energy consumption will depend on how the appliance is used and where it is located.

(3) SH: Super High

(4) SEER, SCOP and other related description are based on COMMISSION DELEGATED REGULATION (EU) No.626/2011. The temperature conditions for calculating SCOP are based on "Average Season".

(5) Please see page 57-59 for heating (warmer season) specifications.

(6) For single use: only 26dB(A). For multi use (MXZ): 28dB(A).

(7) For single use: only 28dB(A). For multi use (MXZ): 30dB(A).

MSZ-DM SERIES

R410A

MSZ-DM25/35VA

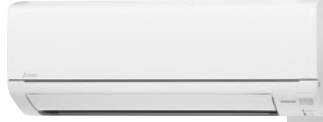

Compact, high-performance indoor and outdoor units equipped with high-performance air purifying filters contribute to greater room comfort. Wi-Fi and system controller connectivity enable enhanced expandability.

Advanced Inverter Control – Efficient Operation All the Time



Mitsubishi Electric's cutting-edge inverter technologies are adopted to provide automatic adjustment of operation load according to need. This reduces excessive consumption of electricity, and thereby realises an Energy Rank "A+."

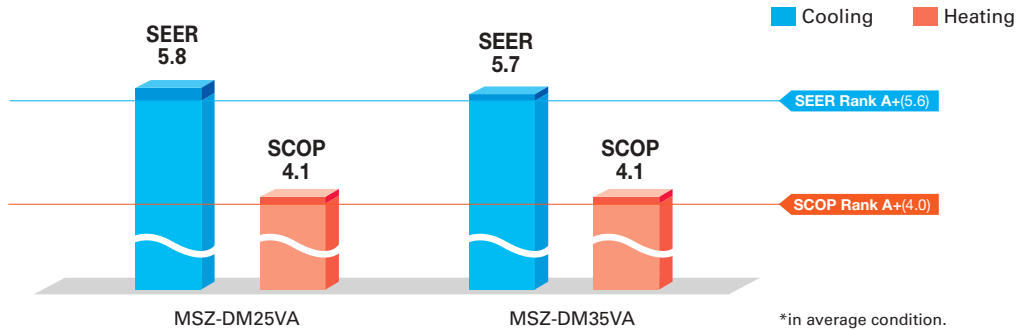

Wider Cooling Operating Range

As a result of an extended operating range in cooling, these models accommodate a wider range of usage environments and applications than previous models.

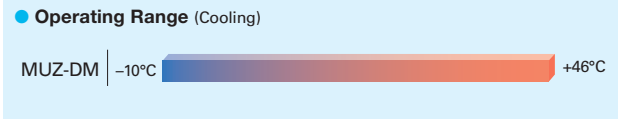

Wi-Fi and System Control

Wi-Fi Interface (Optional)

Optional interface enabling users to control air conditioners and check operating status via devices such as personal computers, tablets and smartphones.

System Control Interface (Optional)

- Remote on/off operation is possible by input to the connector.
- Depending on the interface used, connecting a wired remote-control such as the PAR-41MAA is possible.
- Centralised control is possible when connected to M-NET.

*Wi-Fi Interface and System Control Interface cannot be used simultaneously.

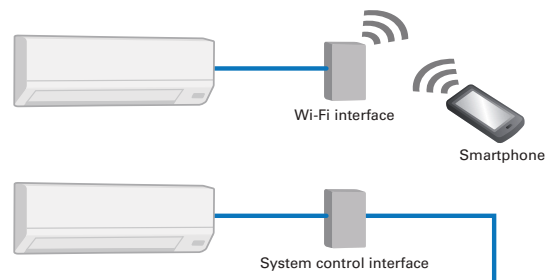

Silver-ionized Air Purifier Filter

The high performance filter is attached as standard. Captures the bacteria, pollen and other allergens in the air and neutralises them.

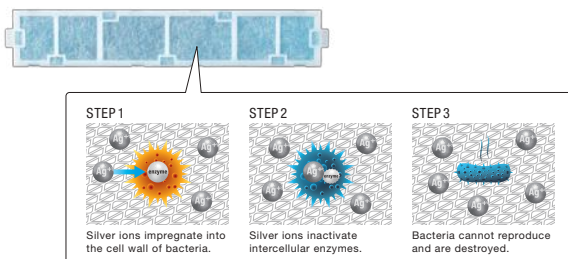

Compact Units

The width of both indoor and outdoor units are compact, making installation in smaller, tighter spaces possible.

Indoor Unit: MSZ-DM25VA

Outdoor Unit: MUZ-DM25/35VA

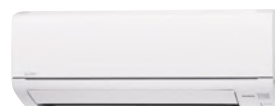

Only 799mm width



Only 699mm width

MSZ-DM SERIES



Indoor Unit

R410A



MSZ-DM25/35VA

Outdoor Unit

R410A



MUZ-DM25/35VA

Remote Controller

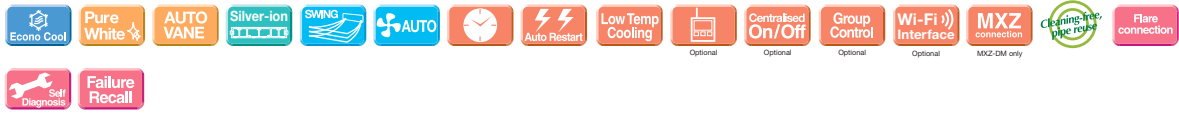

Type	Inverter Heat Pump			
Indoor Unit	MSZ-DM25VA		MSZ-DM35VA	
Outdoor Unit	MUZ-DM25VA		MUZ-DM35VA	
Refrigerant	R410A ⁽¹⁾			
Power Source	Indoor Power supply			
Supply	Outdoor (V / Phase / Hz)			
		230V/Single/50Hz		
Cooling	Design load	kW	2.5	
	Annual electricity consumption ⁽²⁾	kWh/a	149	
	SEER ⁽⁴⁾		5.8	
	Energy efficiency class			A+
		Capacity	kW	3.15
Capacity	Rated	kW	2.5	
	Min-Max	kW	1.3 - 3.0	
Total Input	Rated	kW	0.710	
	Rated	kW	1.020	
Heating (Average Season) ⁽³⁾	Design load	kW	1.9 (-10°C)	
	Declared Capacity	at reference design temperature	kW	1.9 (-10°C)
		at bivalent temperature	kW	1.9 (-10°C)
		at operation limit temperature	kW	1.9 (-10°C)
	Back up heating capacity	kW	0.0 (-10°C)	
	Annual electricity consumption ⁽²⁾	kWh/a	647	
	SCOP ⁽⁴⁾		4.1	
	Energy efficiency class			A+
		Capacity	kW	3.6
	Capacity	Rated	kW	3.15
Min-Max		kW	0.9 - 3.5	
Total Input	Rated	kW	0.850	
	Rated	kW	0.975	
Operating Current (Max)		A	5.8	
	Input	kW	0.020	
Operating Current(Max)		A	0.3	
	Dimensions	H*W*D	290-799-232	
Weight		kg	9	
	Air Volume (SLo-Lo-Mid-Hi-SHi ⁽⁵⁾)	Cooling	m ³ /min	
Sound Level (SPL) (SLo-Lo-Mid-Hi-SHi ⁽⁵⁾)	Heating	m ³ /min	3.8 - 5.5 - 7.3 - 9.5	
	Cooling	m ³ /min	3.5 - 5.5 - 7.5 - 10.0	
Sound Level (PWL)	Cooling	dB(A)	22 - 30 - 37 - 43	
	Heating	dB(A)	23 - 30 - 37 - 43	
Dimensions	Cooling	dB(A)	57	
	Heating	dB(A)	60	
Weight	H*W*D	mm	538-699-249	
	Weight	kg	24	
Air Volume	Cooling	m ³ /min	31.5	
	Heating	m ³ /min	31.5	
Sound Level (SPL)	Cooling	dB(A)	50	
	Heating	dB(A)	51	
Sound Level (PWL)	Cooling	dB(A)	63	
	Heating	dB(A)	64	
Operating Current (Max)	A		5.5	
	Breaker Size	A	10	
Ext. Piping	Diameter	Liquid/Gas	6.35/9.52	
	Max.Length	Out-In	20	
	Max.Height	Out-In	12	
Guaranteed Operating Range (Outdoor)	Cooling	°C	-10 - +46	
	Heating	°C	-10 - +24	

(1) Refrigerant leakage contributes to climate change. Refrigerant with lower global warming potential (GWP) would contribute less to global warming than a refrigerant with higher GWP, if leaked to the atmosphere. This appliance contains a refrigerant fluid with a GWP equal to 1975. This means that if 1 kg of this refrigerant fluid would be leaked to the atmosphere, the impact on global warming would be 1975 times higher than 1 kg of CO₂, over a period of 100 years. Never try to interfere with the refrigerant circuit yourself or disassemble the product yourself and always ask a professional.
The GWP of R410A is 2088 in the IPCC 4th Assessment Report.

(2) Energy consumption based on standard test results. Actual energy consumption will depend on how the appliance is used and where it is located.

(3) SHi: Super High

(4) SEER, SCOP and other related description are based on COMMISSION DELEGATED REGULATION (EU) No.626/2011. The temperature conditions for calculating SCOP are based on "Average Season".

(5) Please see page 57-59 for heating (warmer season) specifications.

MSZ-HJ SERIES

Compact, high-performance indoor and outdoor units and advanced inverter technologies provide superior energy savings and comfort in all rooms.

R410A

MSZ-HJ25/35/50VA

MSZ-HJ60/71VA



Stylish Design with Flat Panel Front

A stylish flat panel design is employed for the front of the indoor unit. The simple look matches room aesthetics.



Advanced Inverter Control – Efficient Operation All the Time

DC Inverter



Mitsubishi Electric's cutting-edge inverter technologies are adopted to provide automatic adjustment of operation load according to need. This reduces excessive consumption of electricity, and thereby realises an Energy Rank "A" rating for 25/35 classes and "A+" for 50/60/71 classes.

Silent Operation

Quiet, relaxing space is within reach. Operational noise is a low 22dB (25/35 classes). Operation is so silent you might even forget the air conditioner is on.

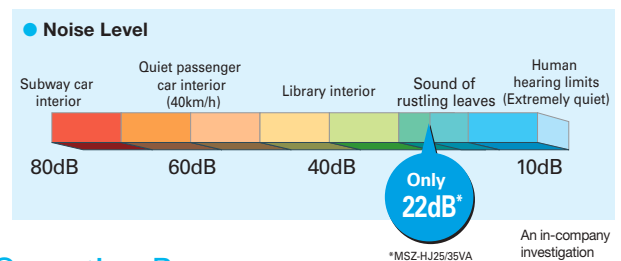

Long Piping Length

Compared to previous models, the piping length is significantly increased, further enhancing the ease and flexibility of installation.

	MSZ-HJ60/71	MSZ-HJ25/35/50	MSZ-HC
Max piping length	30m	20m	10m
Max piping height difference	15m	12m	5m

Operating Range

As a result of an extended operating range in cooling, these models accommodate a wider range of usage environments and applications than previous models.

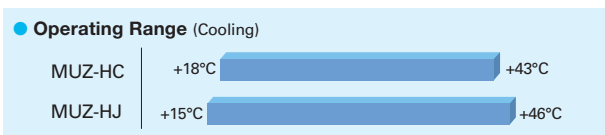

Compact Units

The widths of both indoor and outdoor units are compact, making installation in smaller, tighter spaces possible.

Indoor Unit: MSZ-HJ25/35/50VA



Only 799mm width

Outdoor Unit: MUZ-HJ25/35VA



Only 699mm width

Compared to other models, width is down by 16%.

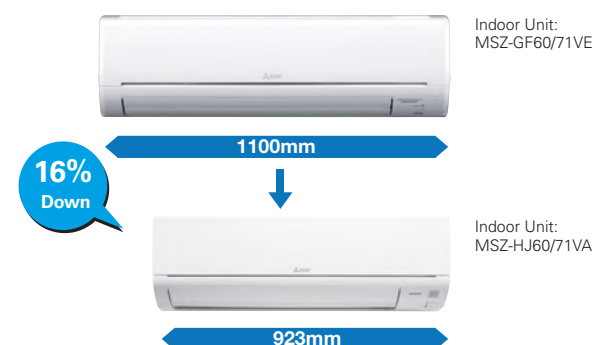

MSZ-HJ SERIES



Indoor Unit **R410A**



MSZ-HJ25/35/50VA



MSZ-HJ60/71VA

Outdoor Unit **R410A**



MUZ-HJ25/35VA



MUZ-HJ50VA



MUZ-HJ60/71VA

Remote Controller



Type		Inverter Heat Pump						
Indoor Unit		MSZ-HJ25VA	MSZ-HJ35VA	MSZ-HJ50VA	MSZ-HJ60VA	MSZ-HJ71VA		
Outdoor Unit		MUZ-HJ25VA	MUZ-HJ35VA	MUZ-HJ50VA	MUZ-HJ60VA	MUZ-HJ71VA		
Refrigerant		R410A ⁽¹⁾						
Power Source		Indoor Power supply						
Supply	Outdoor (V / Phase / Hz)	230V/Single/50Hz						
Cooling	Design load	kW	2.5	3.1	5.0	6.1	7.1	
	Annual electricity consumption ⁽²⁾	kWh/a	171	212	292	354	441	
	SEER ⁽⁴⁾		5.1	5.1	6.0	6.0	5.6	
	Energy efficiency class		A					
			A+					
Capacity	Rated	kW	2.5	3.15	5.0	6.1	7.1	
	Min-Max	kW	1.3 - 3.0	1.4 - 3.5	1.3 - 5.0	1.7 - 7.1	1.8 - 7.1	
Total Input	Rated	kW	0.730	1.040	2.050	1.900	2.330	
Heating (Average Season) ⁽³⁾	Design load	kW	1.9 (-10°C)	2.4 (-10°C)	3.8 (-10°C)	4.6 (-10°C)	5.4 (-10°C)	
	Declared Capacity	at reference design temperature	kW	1.9 (-10°C)	2.4 (-10°C)	3.8 (-10°C)	4.6 (-10°C)	5.4 (-10°C)
		at bivalent temperature	kW	1.9 (-10°C)	2.4 (-10°C)	3.8 (-10°C)	4.6 (-10°C)	5.4 (-10°C)
		at operation limit temperature	kW	1.9 (-10°C)	2.4 (-10°C)	3.8 (-10°C)	4.6 (-10°C)	5.4 (-10°C)
	Back up heating capacity	kW	0.0 (-10°C)	0.0 (-10°C)	0.0 (-10°C)	0.0 (-10°C)	0.0 (-10°C)	
	Annual electricity consumption ⁽²⁾	kWh/a	698	885	1267	1544	1854	
	SCOP ⁽⁴⁾		3.8	3.8	4.2	4.1	4.0	
	Energy efficiency class		A					
			A+					
	Capacity	Rated	kW	3.15	3.6	5.4	6.8	8.1
Min-Max		kW	0.9 - 3.5	1.1 - 4.1	1.4 - 6.5	1.5 - 8.4	1.5 - 8.5	
Total Input	Rated	kW	0.870	0.995	1.480	1.970	2.440	
Operating Current (Max)	Input	A	5.8	6.5	9.8	12.5	12.5	
	Rated	kW	0.020	0.024	0.037	0.055	0.055	
Indoor Unit	Operating Current(Max)	A	0.3	0.3	0.4	0.5	0.5	
	Dimensions	H*W*D	mm	290-799-232	290-799-232	290-799-232	305-923-250	305-923-250
Outdoor Unit	Weight	kg	9	9	9	13	13	
	Air Volume	Cooling	m ³ /min	3.8 - 5.5 - 7.3 - 9.5	3.8 - 5.7 - 7.8 - 10.9	6.3 - 9.1 - 11.1 - 12.9	9.3 - 12.2 - 15.0 - 19.9	10.0 - 12.2 - 15.0 - 19.9
		Heating	m ³ /min	3.5 - 5.5 - 7.5 - 10.0	3.5 - 5.5 - 7.5 - 10.3	6.1 - 8.3 - 11.1 - 14.3	9.4 - 12.5 - 16.0 - 19.9	10.3 - 12.7 - 16.4 - 19.9
	Sound Level (SPL) (SLo-Lo-Mid-Hi-SH) ⁽⁵⁾	Cooling	dB(A)	22 - 30 - 37 - 43	22 - 31 - 38 - 45	28 - 36 - 40 - 45	31 - 38 - 44 - 50	33 - 38 - 44 - 50
		Heating	dB(A)	23 - 30 - 37 - 43	23 - 30 - 37 - 44	27 - 34 - 41 - 47	31 - 38 - 44 - 49	33 - 38 - 44 - 49
	Sound Level (PWL)	Cooling	dB(A)	57	60	65	65	65
Dimensions	H*W*D	mm	538-699-249	538-699-249	550-800-285	880-840-330	880-840-330	
Outdoor Unit	Weight	kg	24	25	36	55	55	
	Air Volume	Cooling	m ³ /min	31.5	31.5	36.3	47.9	49.3
		Heating	m ³ /min	31.5	31.5	34.8	47.9	47.9
	Sound Level (SPL)	Cooling	dB(A)	50	50	55	55	55
		Heating	dB(A)	50	50	51	55	55
	Sound Level (PWL)	Cooling	dB(A)	63	64	64	65	66
Operating Current (Max)	A	5.5	6.2	9.4	12.0	12.0		
Ext. Piping	Breaker Size	A	10	10	12	16	16	
	Diameter	Liquid/Gas	mm	6.35/9.52	6.35/9.52	6.35/12.7	6.35/15.88	9.52/15.88
Ext. Piping	Max.Length	Out-In	m	20	20	20	30	30
	Max.Height	Out-In	m	12	12	12	15	15
Guaranteed Operating Range (Outdoor)	Cooling	°C	+15 ~ +46	+15 ~ +46	+15 ~ +46	+15 ~ +46	+15 ~ +46	
	Heating	°C	-10 ~ +24	-10 ~ +24	-10 ~ +24	-10 ~ +24	-10 ~ +24	

(1) Refrigerant leakage contributes to climate change. Refrigerant with lower global warming potential (GWP) would contribute less to global warming than a refrigerant with higher GWP, if leaked to the atmosphere. This appliance contains a refrigerant fluid with a GWP equal to 1975. This means that if 1 kg of this refrigerant fluid would be leaked to the atmosphere, the impact on global warming would be 1975 times higher than 1 kg of CO₂ over a period of 100 years. Never try to interfere with the refrigerant circuit yourself or disassemble the product yourself and always ask a professional.

The GWP of R410A is 2088 in the IPCC 4th Assessment Report.

(2) Energy consumption based on standard test results. Actual energy consumption will depend on how the appliance is used and where it is located.

(3) SHi: Super High

(4) SEER, SCOP and other related description are based on COMMISSION DELEGATED REGULATION (EU) No.626/2011. The temperature conditions for calculating SCOP are based on "Average Season".

(5) Please see page 57-59 for heating (warmer season) specifications.

MFZ SERIES

High Capacity, Energy Savings and a Design in Harmony with Living Spaces
Raise the Value of Your Room to the Next Level.

MFZ-KT25/35/50/60VG

R32



Simple, Flat Design

Uneven surfaces have been smoothed to provide a simple design with linear beauty, harmonised with all types of interiors.

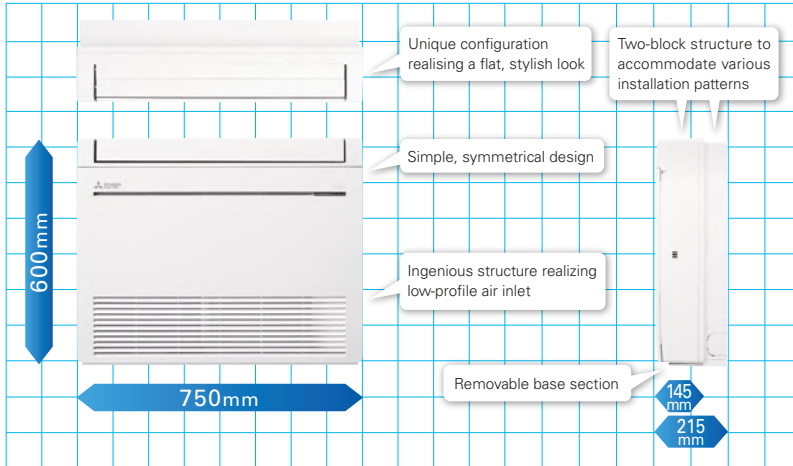

Images of installed unit

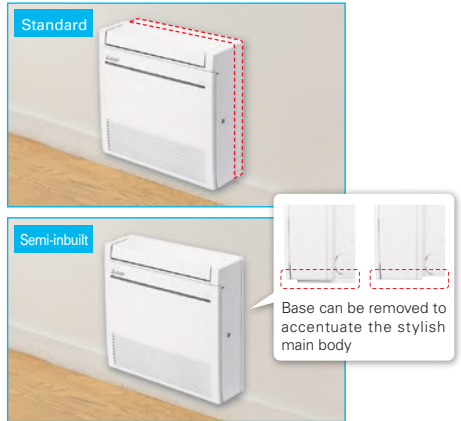

New Line-up

New models have been introduced to expand the line-up. The diverse selection enables the best solution for both customers and locations.

Capacity	2.5kW	3.5kW	5.0kW	6.0kW
MFZ-KJ	✓	✓	✓	
MFZ-KT	✓	✓	✓	✓

Multi-flow Vane

Three uniquely shaped vanes control the airflow and allow the freedom to customize comfort according to preferences.

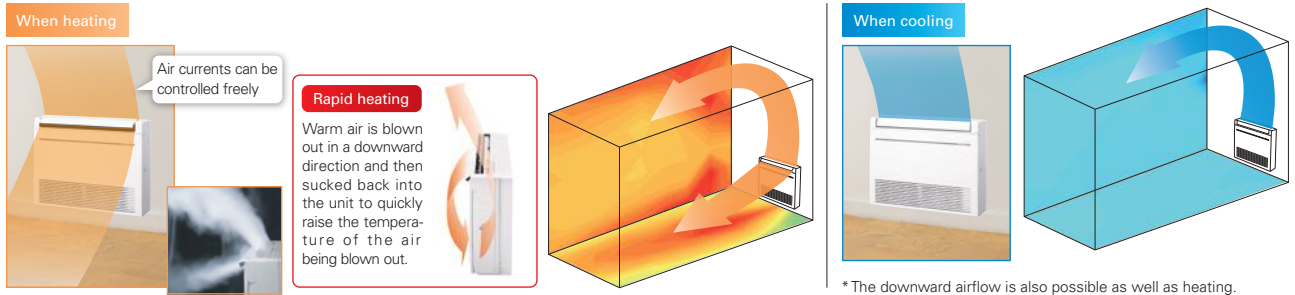

Weekly Timer (Introduced in response to market demand)

Temperature settings and On/Off control can be managed over a period of one week using the Weekly Timer. Up to eight setting patterns per calendar day are possible.

V Blocking Filter



V Blocking Filter with antiviral effect inhibits 99% of adhered virus, and other harmful substances, such as bacteria, mold and allergen. Two-layered filter with non-woven fabric and electrostatic capture and remove small particles from the air in your room.

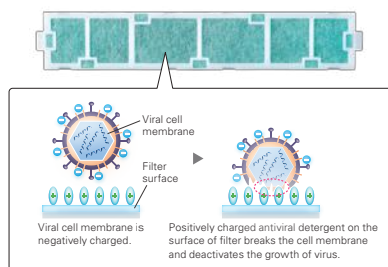

Quiet Operation

The indoor unit noise level is as low as 19dB for MFZ Series, offering a peaceful inside environment.

* Single connection only.

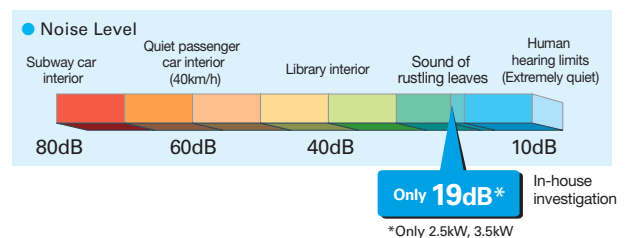

MFZ-KT SERIES



Indoor Unit

R32



MFZ-KT25/35/50/60VG

Outdoor Unit

R32



SUZ-M25/35VA



SUZ-M50VA



SUZ-M60VA

Remote Controller



Enclosed in MFZ-KT



*optional



*optional



*optional

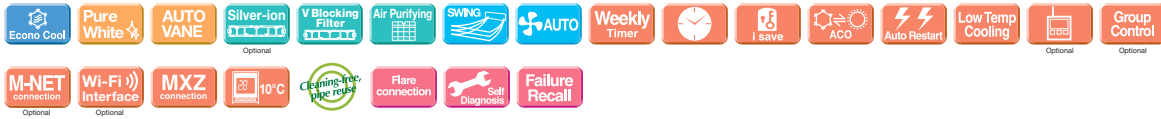

Type		Inverter Heat Pump					
Indoor Unit		MFZ-KT25VG	MFZ-KT35VG	MFZ-KT50VG	MFZ-KT60VG		
Outdoor Unit		SUZ-M25VA	SUZ-M35VA	SUZ-M50VA	SUZ-M60VA		
Refrigerant		R32 ^(*)	R32 ^(*)	R32 ^(*)	R32 ^(*)		
Power Supply		Outdoor power supply 230 / Single / 50					
Cooling	Design load	kW	2.5	3.5	5.0	6.1	
	Annual electricity consumption ⁽²⁾	kWh/a	134	185	257	343	
	SEER ^{(4), (5)}		6.5	6.6	6.8	6.2	
	Capacity	Energy efficiency class		A ⁺⁺	A ⁺⁺	A ⁺⁺	A ⁺⁺
		Rated	kW	2.5	3.5	5.0	6.1
Total Input	Min-Max	kW	1.6 - 3.2	0.9 - 3.9	1.2 - 5.6	1.7 - 6.3	
	Rated	kW	0.62	1.06	1.55	1.84	
Heating (Average Season)	Design load	kW	2.2	2.6	4.3	4.6	
	Declared Capacity	at reference design temperature	kW	2.0 (-10°C)	2.3 (-10°C)	3.5 (-10°C)	4.1 (-10°C)
		at bivalent temperature	kW	2.0 (-7°C)	2.3 (-7°C)	3.9 (-7°C)	4.1 (-7°C)
		at operation limit temperature	kW	2.0 (-10°C)	2.3 (-10°C)	3.5 (-10°C)	4.1 (-10°C)
	Back up heating capacity	kW	0.2	0.3	0.8	0.5	
	Annual electricity consumption ⁽²⁾	kWh/a	732	825	1423	1568	
	SCOP ^{(4), (5)}		4.2	4.4	4.2	4.1	
Capacity	Energy efficiency class		A ⁺	A ⁺	A ⁺	A ⁺	
	Rated	kW	3.4	4.3	6.0	7.0	
Total Input	Min-Max	kW	1.3 - 4.2	1.1 - 5.0	1.5 - 7.2	1.6 - 8.0	
	Rated	kW	0.91	1.26	1.86	2.18	
Operating Current (Max)							
Indoor Unit	Input	Rated	kW	0.020 / 0.024	0.020 / 0.024	0.037 / 0.052	0.063 / 0.059
	Operating Current(Max)		A	0.20	0.20	0.45	0.55
	Dimensions	H*W*D	mm	600-750-215	600-750-215	600-750-215	600-750-215
	Weight		kg	14.5	14.5	14.5	15.0
	Air Volume (SLO-Lo-Mid-Hi-SHI ⁽³⁾)	Cooling	m ³ /min	3.9 - 4.8 - 6.5 - 7.8 - 8.9	3.9 - 4.8 - 6.5 - 7.8 - 8.9	5.6 - 6.7 - 8.6 - 10.4 - 12.3	5.6 - 8.0 - 9.6 - 12.3 - 15.0
		Heating	m ³ /min	3.5 - 4.0 - 5.6 - 7.3 - 9.7	3.5 - 4.0 - 5.6 - 7.3 - 9.7	6.0 - 7.7 - 9.4 - 11.6 - 14.0	6.0 - 7.7 - 9.7 - 12.5 - 14.6
	Sound Level (SPL) (SLO-Lo-Mid-Hi-SHI ⁽³⁾)	Cooling	dB(A)	19 - 24 - 31 - 37 - 41	19 - 24 - 31 - 37 - 41	28 - 32 - 37 - 42 - 48	28 - 36 - 40 - 46 - 53
		Heating	dB(A)	19 - 23 - 30 - 37 - 44	19 - 23 - 30 - 37 - 44	29 - 35 - 40 - 44 - 49	29 - 35 - 41 - 47 - 51
	Sound Level (PWL)	Cooling	dB(A)	54	54	60	65
	Outdoor Unit	Dimensions	H*W*D	mm	550-800-285	550-800-285	714-800-285
Weight			kg	30	35	41	54
Air Volume		Cooling	m ³ /min	36.3	34.3	45.8	50.1
		Heating	m ³ /min	34.6	32.7	43.7	50.1
Sound Level (SPL)		Cooling	dB(A)	45	48	48	49
		Heating	dB(A)	46	48	49	51
Sound Level (PWL)		Cooling	dB(A)	59	59	64	65
Operating Current(Max)			A	7	9	14	15
Breaker Size			A	10	10	16	16
Ext. Piping		Diameter	Liquid/Gas	mm	6.35 / 9.52	6.35 / 9.52	6.35 / 12.7
	Max.Length	Out-In	m	20	20	30	30
	Max.Height	Out-In	m	12	12	30	30
Guaranteed Operating Range [Outdoor]							
		Cooling	°C	-10 ~ +46	-10 ~ +46	-15 ~ +46	-15 ~ +46
		Heating	°C	-10 ~ +24	-10 ~ +24	-10 ~ +24	-10 ~ +24

(*) Refrigerant leakage contributes to climate change. Refrigerant with lower global warming potential (GWP) would contribute less to global warming than a refrigerant with higher GWP, if leaked to the atmosphere. This appliance contains a refrigerant fluid with a GWP equal to 1975. This means that if 1 kg of this refrigerant fluid would be leaked to the atmosphere, the impact on global warming would be 1975 times higher than 1 kg of CO₂, over a period of 100 years. Never try to interfere with the refrigerant circuit yourself or disassemble the product yourself and always ask a professional.
The GWP of R410A is 2088 in the IPCC 4th Assessment Report.

(2) Energy consumption based on standard test results. Actual energy consumption will depend on how the appliance is used and where it is located.

(3) SH: Super High

(4) SEER, SCOP and other related description are based on COMMISSION DELEGATED REGULATION (EU) No 626/2011. The temperature conditions for calculating SCOP are based on "Average Season".

(5) SEER and SCOP are based on 2009/125/EC Energy-related Products Directive and Regulation (EU) No 206/2012.

MLZ SERIES

Introducing a new type of ceiling cassette for the Multi-Split Series with streamlined interior dimensions and a sharp, sleek appearance.

MLZ-KP25/35/50VF

R32

MLZ-KY20VG



reddot award 2018 winner



Slim Design KY KP

Industry leading slim body realized a simple design with linear beauty.

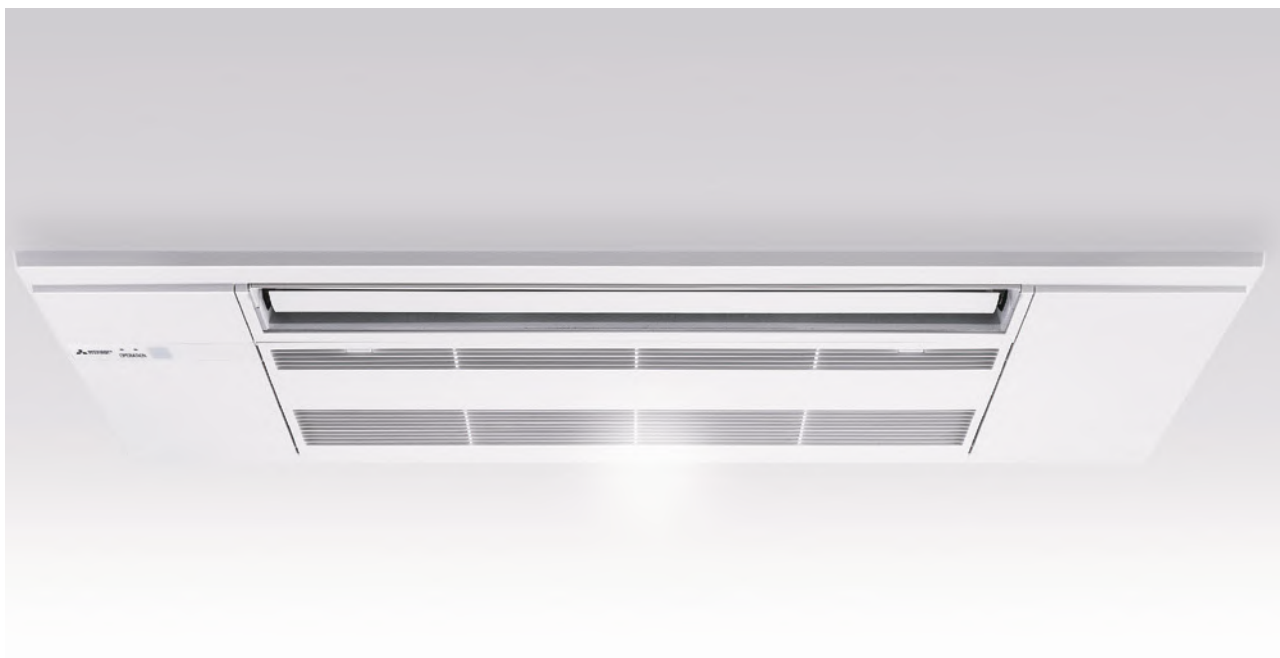

Ceiling Mounted KY KP

Installing the ceiling-mounted MLZ Series unit in a room creates a more spacious feel that enhances room comfort. This overhead format is also an excellent solution when lighting equipment is installed at the centre of the room and fixtures such as book shelves are mounted on wall surfaces.

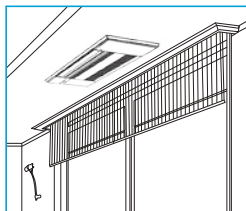

Slim Body KY

V Blocking Filter with antiviral effect inhibits 99% of adhered virus and other harmful substances, such as bacteria, mold and allergen. Two-layered filter with non-woven fabric and electrostatic filter can effectively capture and remove small particles from the air in your room.

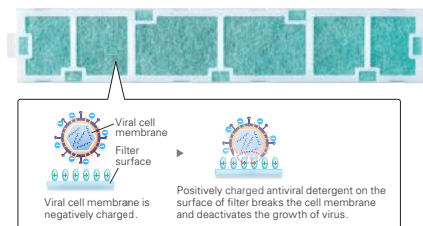

Set Airflow According to Ceiling Height KY KP

Dual-level airflow selection is engineered to accommodate specific ceiling heights. This is a key feature for adjusting airflow effectively when it is either too strong or too weak due to being mismatched with the height of the ceiling.

	20	25	35	50
Standard	2.4m	2.4m	2.4m	2.4m
High ceiling	2.7m	2.7m	2.7m	2.7m

Auto Vane Control KY KP

Outlet vanes can be moved left and right, and up and down using the remote controller. This improved airflow control feature solves the problem of drafts.

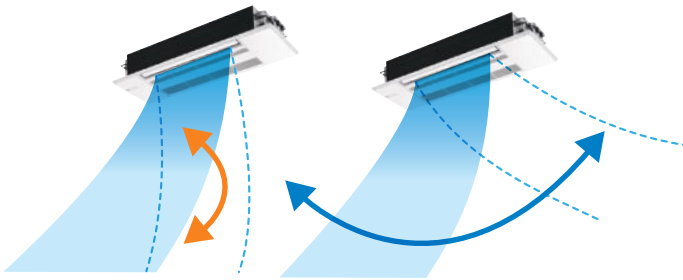

Up and Down

Left and Right

*Only available when Econo Cool is set.

Horizontal Airflow KY KP

The new airflow control completely eliminates that uncomfortable drafty-feeling with the introduction of a horizontal airflow that spreads across the ceiling. The ideal airflow for offices and restaurants.

[Horizontal Airflow]
Model name: MLZ-KP35VF
Ceiling height: 2.4m
Model: Cooling

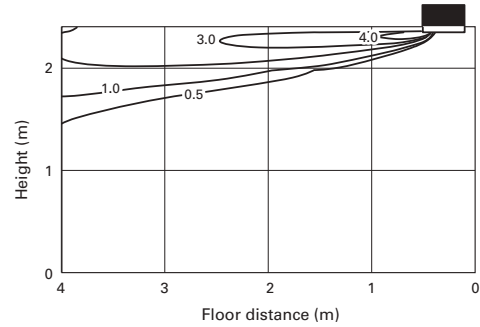

Weekly Timer KY KP Built-in Weekly Timer Function

Easily set desired temperatures and operation ON/OFF times to match lifestyle patterns. Reduce wasted energy consumption by using the timer to prevent forgetting to turn off the unit and eliminate temperature setting adjustments.

Example Operation Pattern (Winter/Heating mode)

	Mon.	Tues.	Wed.	Thurs.	Fri.	Sat.	Sun.
6:00	ON 20°C	ON 20°C	ON 20°C	ON 20°C	ON 20°C	ON 20°C	ON 20°C
8:00	Automatically changes to high-power operation at wake-up time						
10:00	OFF	OFF	OFF	OFF	OFF	ON 18°C	ON 18°C
12:00	Automatically turned off during work hours					Midday is warmer, so the temperature is set lower	
14:00							
16:00							
18:00	ON 22°C	ON 22°C	ON 22°C	ON 22°C	ON 22°C	ON 22°C	ON 22°C
20:00	Automatically turns on, synchronized with arrival at home					Automatically raises temperature setting to match time when outside-air temperature is low	
22:00							
(during sleeping hours)	ON 18°C	ON 18°C	ON 18°C	ON 18°C	ON 18°C	ON 10°C	ON 10°C
	Automatically lowers temperature at bedtime for energy-saving operation at night						

Settings

Pattern Settings: Input up to four settings for each day

Settings: •Start/Stop operation •Temperature setting *The operation mode cannot be set.

Easy set-up using dedicated buttons



The remote controller is equipped with buttons that are used exclusively for setting the Weekly Timer. Setting operation patterns is easy and quick.



How to set the Weekly Timer

Complete

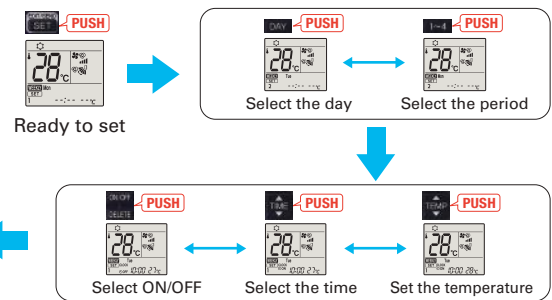

- Start by pushing the "SET" button and follow the instructions to set the desired patterns. Once all of the desired patterns are input, point the top end of the remote controller at the indoor unit and push the "SET" button one more time. (Push the "SET" button only after inputting all of the desired patterns into the remote controller memory. Pushing the "CANCEL" button will end the set-up process without sending the operation patterns to the indoor unit).
- It takes a few seconds to transmit the Weekly Timer operation patterns to the indoor unit. Please continue to point the remote controller at the indoor unit until all data has been sent.

Easy Installation

Temporary hanging hook KY KP

Work efficiency has improved during installation.

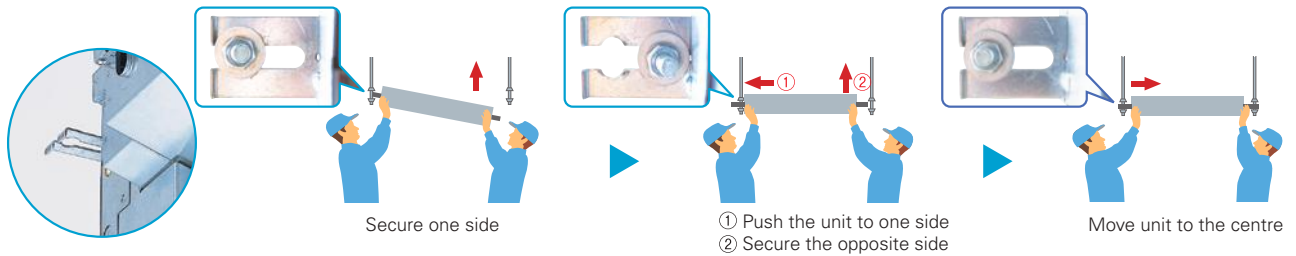

Refrigerant Piping Supporters + Drain Cover KY KP

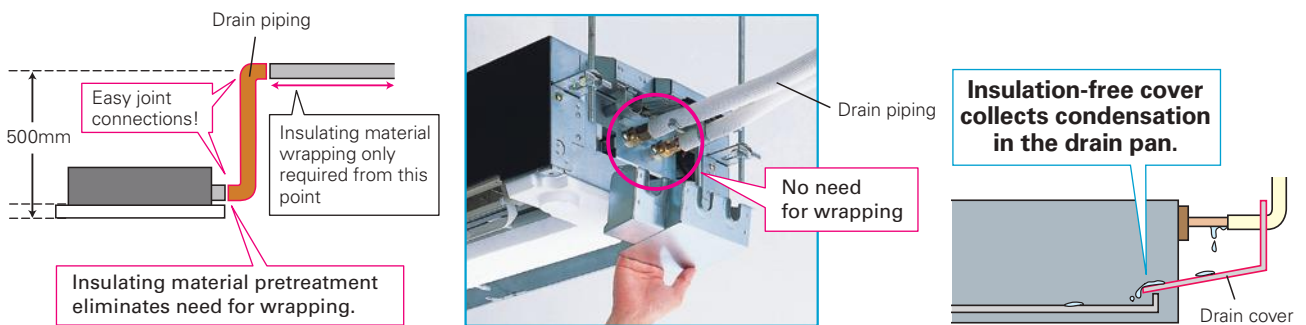

High Serviceability KY KP

No need to put off the panel even when the unit has some troubles to be checked inside. Simply open the panel to see the inside of the unit.



Wi-Fi Space

There is space inside the panel for a Wi-Fi interface.

* This image is for MLZ-KY

MLZ SERIES



Indoor Unit R32



MLZ-KP25/35/50VF



R32



MLZ-KY20VG

Panel

MLP-444W

MLP-448W

Outdoor Unit



SUZ-M25/35VA



SUZ-M50VA

For Multi Connection Only

Remote Controller



Built in MLZ-KP/KY



*optional



*optional



*optional

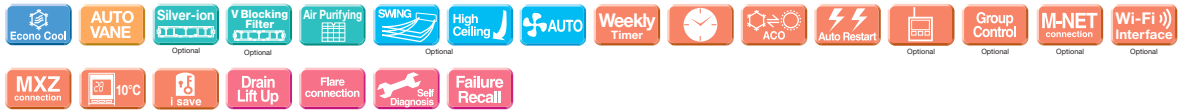

Type	Inverter Heat Pump						
Indoor Unit	MLZ-KP25VF	MLZ-KP35VF	MLZ-KP50VF	MLZ-KY20VG			
Outdoor Unit	SUZ-M25VA	SUZ-M35VA	SUZ-M50VA	For Multi connection only			
Refrigerant	R32 ⁽¹⁾						
Power Supply	Outdoor Power supply						
	230V / Single / 50Hz						
Cooling	Design load	kW	2.5	3.5	5.0	-	
	Annual electricity consumption ⁽²⁾	kWh/a	141	175	260	-	
	SEER ^{(4), (5)}		6.2	7.0	6.7	-	
	Energy efficiency class			A++	A++	A++	-
		Rated	kW	2.5	3.5	5.0	-
	Capacity	Min-Max	kW	1.4 - 3.2	0.8 - 3.9	1.7 - 5.6	-
Total Input	Rated	kW	0.59	0.94	1.38	-	
Heating (Average Season)	Design load	kW	2.2	2.6	4.3	-	
	Declared Capacity	at reference design temperature	kW	2.0 (-10°C)	2.3 (-10°C)	3.8 (-10°C)	-
		at bivalent temperature	kW	2.0 (-7°C)	2.3 (-7°C)	3.8 (-7°C)	-
		at operation limit temperature	kW	2.0 (-10°C)	2.3 (-10°C)	3.8 (-10°C)	-
	Back up heating capacity	kW	0.2	0.3	0.5	-	
	Annual electricity consumption ⁽²⁾	kWh/a	697	791	1397	-	
	SCOP ^{(4), (5)}		4.4	4.6	4.3	-	
	Energy efficiency class			A+	A++	A+	-
		Rated	kW	3.2	4.1	6.0	-
	Capacity	Min-Max	kW	1.4 - 4.2	1.1 - 4.9	1.7 - 7.2	-
Total Input	Rated	kW	0.80	1.10	1.86	-	
Operating Current (Max)	Input	A	7.2	8.9	13.9	-	
	Operating Current (Max)	A	0.40	0.40	0.40	0.12	
Indoor Unit	Dimensions	H*W*D	mm	185-1102-360	185-1102-360	185-1102-360	194-842-301
	Weight		kg	15.5	15.5	15.5	14
	Air Volume (SLo-Le-Mid-Hi ⁽³⁾)	Cooling	m ³ /min	6.0-7.2-8.0-8.8	6.0-7.3-8.4-9.4	6.0-8.3-9.8-11.4	4.3-4.7-5.2-5.6
		Heating	m ³ /min	6.0-7.0-8.2-9.2	6.0-7.7-8.8-9.9	6.0-8.8-10.3-11.8	4.3-4.9-5.5-6.0
	Sound Level (SPL) (SLo-Le-Mid-Hi ⁽³⁾)	Cooling	dB(A)	27-31-34-38	27-32-36-40	29-36-41-47	30-32-34-37
		Heating	dB(A)	26-27-34-37	29-32-36-40	26-37-42-48	29-32-35-58
Sound Level (PWL)	Cooling	dB(A)	52	53	59	40-42-44-50	
Panel	Dimensions	H*W*D	mm	24-1200-424	24-1200-424	24-1200-424	34-915-370
	Weight		kg	3.5	3.5	3.5	3.8
Outdoor Unit	Dimensions	H*W*D	mm	550-800-285	550-800-285	550-800-285	-
	Weight		kg	30	35	41	-
	Air Volume	Cooling	m ³ /min	36.3	34.3	45.8	-
		Heating	m ³ /min	34.6	32.7	43.7	-
	Sound Level (SPL)	Cooling	dB(A)	45	48	48	-
		Heating	dB(A)	46	48	49	-
Sound Level (PWL)	Cooling	dB(A)	59	59	64	-	
Operating Current (Max)	A		6.8	8.5	13.5	-	
Breaker Size	A		10	10	20	-	
Ext. Piping	Diameter	Liquid/Gas	mm	6.35/9.52	6.35/9.52	6.35/12.7	6.35/9.52
	Max.Length	Out-In	m	20	20	30	-
	Max.Height	Out-In	m	12	12	30	-
Guaranteed Operating Range (Outdoor)	Cooling	°C	-10~+46	-10~+46	-15~+46	-	
	Heating	°C	-10~+24	-10~+24	-10~+24	-	

(1) Refrigerant leakage contributes to climate change. Refrigerant with lower global warming potential (GWP) would contribute less to global warming than a refrigerant with higher GWP, if leaked to the atmosphere. This appliance contains a refrigerant fluid with a GWP equal to 1975. This means that if 1 kg of this refrigerant fluid would be leaked to the atmosphere, the impact on global warming would be 1975 times higher than 1 kg of CO₂, over a period of 100 years. Never try to interfere with the refrigerant circuit yourself or disassemble the product yourself and always ask a professional.

(2) The GWP of R410A is 2088 in the IPCC 4th Assessment Report.

(3) Energy consumption based on standard test results. Actual energy consumption will depend on how the appliance is used and where it is located.

(4) SEER, SCOP and other related description are based on COMMISSION DELEGATED REGULATION (EU) No.626/2011. The temperature conditions for calculating SCOP are based on "Average Season".

(5) SEER and SCOP are based on 2009/125/EC:Energy-related Products Directive and Regulation(EU) No206/2012.

Specification on Warmer/Colder Condition

Type		Inverter Heat Pump				
Indoor Unit		MSZ-RW25VG	MSZ-RW35VG	MSZ-RW50VG		
Outdoor Unit		MUZ-RW25VGHZ	MUZ-RW35VGHZ	MUZ-RW50VGHZ		
Refrigerant		R32 ⁽³⁾				
Cooling	Design load	kW	2.5	3.5	5.0	
	Annual electricity consumption ⁽²⁾	kWh/a	78	130	230	
	SEER		11.2	9.4	7.6	
		Energy efficiency class	A+++	A+++	A++	
Heating (Warmer Season)	Design load	kW	1.8	2.2	3.3	
	Declared Capacity	at reference design temperature	kW	1.8	2.2	3.3
		at bivalent temperature	kW	1.8	2.2	3.3
		at operation limit temperature	kW	2.6	2.6	4.0
	Back up heating capacity	kW	0.0	0.0	0.0	
	Annual electricity consumption ⁽²⁾	kWh/a	372	469	715	
SCOP		6.7	6.5	6.4		
		Energy efficiency class	A+++	A+++	A+++	
Heating (Colder Season)	Design load	kW	4.7	5.9	8.8	
	Declared Capacity	at reference design temperature	kW	3.7	4.0	5.6
		at bivalent temperature	kW	3.2	4.0	6.0
		at operation limit temperature	kW	2.6	2.6	4.0
	Back up heating capacity	kW	1.0	1.9	3.2	
	Annual electricity consumption ⁽²⁾	kWh/a	2407	3083	5157	
SCOP		4.1	4.0	3.5		
		Energy efficiency class	A+	A+	A	

Type		Inverter Heat Pump								
Indoor Unit		MSZ-LN25VG2		MSZ-LN35VG2		MSZ-LN50VG2		MSZ-LN60VG2		
Outdoor Unit		MUZ-LN25VG2	MUZ-LN25VGHZ2	MUZ-LN35VG2	MUZ-LN35VGHZ2	MUZ-LN50VG2	MUZ-LN50VGHZ	MUZ-LN60VG2		
Refrigerant		R32 ⁽³⁾								
Cooling	Design load	kW	2.5	2.5	3.5	3.5	5.0	6.1		
	Annual electricity consumption ⁽²⁾	kWh/a	83	83	129	130	205	230	285	
	SEER		10.5	10.5	9.5	9.4	8.5	7.6	7.5	
		Energy efficiency class	A+++	A+++	A+++	A+++	A+++	A++	A++	
Heating (Warmer Season)	Design load	kW	1.7 (2°C)	1.8 (2°C)	2.0 (2°C)	2.2 (2°C)	2.5 (2°C)	3.3 (2°C)	3.3 (2°C)	
	Declared Capacity	at reference design temperature	kW	1.7 (2°C)	1.8 (2°C)	2.0 (2°C)	2.2 (2°C)	2.5 (2°C)	3.3 (2°C)	3.3 (2°C)
		at bivalent temperature	kW	1.7 (2°C)	1.8 (2°C)	2.0 (2°C)	2.2 (2°C)	2.5 (2°C)	3.3 (2°C)	3.3 (2°C)
		at operation limit temperature	kW	2.5 (-15°C)	2.3 (-25°C)	3.2 (-15°C)	3.1 (-25°C)	4.2 (-15°C)	4.7 (-25°C)	6.0 (-15°C)
	Back up heating capacity	kW	0.0 (2°C)	0.0 (2°C)	0.0 (2°C)	0.0 (2°C)	0.0 (2°C)	0.0 (2°C)	0.0 (2°C)	
	Annual electricity consumption ⁽²⁾	kWh/a	369	382	431	467	602	779	779	
SCOP		6.4	6.6	6.5	6.5	5.8	5.9	5.9		
		Energy efficiency class	A+++	A+++	A+++	A+++	A+++	A+++		
Heating (Colder Season)	Design load	kW	—	4.7 (-22°C)	—	5.9 (-22°C)	—	8.8 (-22°C)	—	
	Declared Capacity	at reference design temperature	kW	—	2.6 (-22°C)	—	3.4 (-22°C)	—	5.1 (-22°C)	—
		at bivalent temperature	kW	—	3.2 (-10°C)	—	4.0 (-10°C)	—	6.0 (-10°C)	—
		at operation limit temperature	kW	—	2.3 (-25°C)	—	3.1 (-25°C)	—	4.7 (-25°C)	—
	Back up heating capacity	kW	—	2.1 (-22°C)	—	2.5 (-22°C)	—	3.7 (-22°C)	—	
	Annual electricity consumption ⁽²⁾	kWh/a	—	2425	—	3075	—	5340	—	
SCOP		—	4.0	—	4.0	—	3.4	—		
		Energy efficiency class	—	A+	—	A+	—	A	—	

Type		Inverter Heat Pump				
Indoor Unit		MSZ-FT25VG	MSZ-FT35VG	MSZ-FT50VG		
Outdoor Unit		MUZ-FT25VGHZ	MUZ-FT35VGHZ	MUZ-FT50VGHZ		
Refrigerant		R32 ⁽³⁾				
Cooling	Design load	kW	2.5	3.5	5.0	
	Annual electricity consumption ⁽²⁾	kWh/a	101	142	243	
	SEER		8.6	8.6	7.2	
		Energy efficiency class	A+++	A+++	A++	
Heating (Warmer Season)	Design load	kW	1.8 (2°C)	2.2 (2°C)	2.7 (2°C)	
	Declared Capacity	at reference design temperature	kW	1.8 (2°C)	2.2 (2°C)	2.7 (2°C)
		at bivalent temperature	kW	1.8 (2°C)	2.2 (2°C)	2.7 (2°C)
		at operation limit temperature	kW	3.0 (-25°C)	3.4 (-25°C)	3.6 (-25°C)
	Back up heating capacity	kW	0.0 (2°C)	0.0 (2°C)	0.0 (2°C)	
	Annual electricity consumption ⁽²⁾	kWh/a	432	527	684	
SCOP		5.8	5.8	5.5		
		Energy efficiency class	A+++	A+++	A+++	
Heating (Colder Season)	Design load	kW	4.7 (-22°C)	5.9 (-22°C)	7.4 (-22°C)	
	Declared Capacity	at reference design temperature	kW	3.1 (-22°C)	3.7 (-22°C)	4.0 (-22°C)
		at bivalent temperature	kW	3.2 (-10°C)	4.0 (-10°C)	5.0 (-10°C)
		at operation limit temperature	kW	3.0 (-25°C)	3.4 (-25°C)	3.6 (-25°C)
	Back up heating capacity	kW	1.6 (-22°C)	2.2 (-22°C)	3.4 (-22°C)	
	Annual electricity consumption ⁽²⁾	kWh/a	2766	3453	4707	
SCOP		3.5	3.5	3.3		
		Energy efficiency class	A	A	B	

Type		Inverter Heat Pump									
Indoor Unit		MSZ-AY25VGK(P)	MSZ-AY25VGK(P)	MSZ-AY35VGK(P)	MSZ-AY35VGK(P)	MSZ-AY42VGK(P)	MSZ-AY42VGK(P)	MSZ-AY50VGK(P)	MSZ-AY50VGK(P)		
Outdoor Unit		MUZ-AY25VG	MUZ-AY25VGH	MUZ-AY35VG	MUZ-AY35VGH	MUZ-AY42VG	MUZ-AY42VGH	MUZ-AY50VG	MUZ-AY50VGH		
Refrigerant		R32 ⁽³⁾									
Cooling	Design load	kW	2.5	2.5	3.5	3.5	4.2	4.2	5.0	5.0	
	Annual electricity consumption ⁽²⁾	kWh/a	100	100	141	141	186	186	232	232	
	SEER ⁽⁴⁾		8.7	8.7	8.7	8.7	7.9	7.9	7.5	7.5	
		Energy efficiency class	A+++	A+++	A+++	A+++	A++	A++	A++	A++	
Heating (Warmer Season)	Design load	kW	1.3 (2°C)	1.3 (2°C)	1.6 (2°C)	1.6 (2°C)	2.1 (2°C)	2.1 (2°C)	2.3 (2°C)	2.3 (2°C)	
	Declared Capacity	at reference design temperature	kW	1.3 (2°C)	1.3 (2°C)	1.6 (2°C)	1.6 (2°C)	2.1 (2°C)	2.1 (2°C)	2.3 (2°C)	2.3 (2°C)
		at bivalent temperature	kW	1.3 (2°C)	1.3 (2°C)	1.6 (2°C)	1.6 (2°C)	2.1 (2°C)	2.1 (2°C)	2.3 (2°C)	2.3 (2°C)
		at operation limit temperature	kW	1.9 (-20°C)	1.9 (-20°C)	2.0 (-20°C)	2.0 (-20°C)	2.7 (-20°C)	2.7 (-20°C)	3.0 (-20°C)	3.0 (-20°C)
	Back up heating capacity	kW	0.0 (2°C)	0.0 (2°C)	0.0 (2°C)	0.0 (2°C)	0.0 (2°C)	0.0 (2°C)	0.0 (2°C)	0.0 (2°C)	
	Annual electricity consumption ⁽²⁾	kWh/a	319	319	376	376	495	495	523	523	
SCOP		5.7	5.7	5.9	5.9	5.9	5.9	6.1	6.1		
		Energy efficiency class	A+++	A+++	A+++	A+++	A+++	A+++	A+++	A+++	

Type		Inverter Heat Pump					
Indoor Unit		MSZ-AP15VG	MSZ-AP20VG	MSZ-AP60VG(K)	MSZ-AP71VG(K)		
Outdoor Unit		MUZ-AP15VG	MUZ-AP20VG	MUZ-AP60VG	MUZ-AP71VG		
Refrigerant		R32 ^(*)					
Cooling	Design load	kW	1.5	2.0	6.1	7.1	
	Annual electricity consumption ⁽²⁾	kWh/a	72	81	288	345	
	SEER		7.2	8.6	7.4	7.2	
		Energy efficiency class	A++	A+++	A++	A++	
Heating (Warmer Season)	Design load	kW	0.9 (2°C)	1.3 (2°C)	2.5 (2°C)	3.7 (2°C)	
	Declared Capacity	at reference design temperature	kW	0.9 (2°C)	1.3 (2°C)	2.5 (2°C)	3.7 (2°C)
		at bivalent temperature	kW	0.9 (2°C)	1.3 (2°C)	2.5 (2°C)	3.7 (2°C)
		at operation limit temperature	kW	1.6 (-15°C)	2.2 (-15°C)	3.7 (-15°C)	5.4 (-15°C)
	Back up heating capacity	kW	0.0 (2°C)	0.0 (2°C)	0.0 (2°C)	0.0 (2°C)	
	Annual electricity consumption ⁽²⁾	kWh/a	265	350	627	891	
SCOP		4.7	5.2	5.5	5.8		
		Energy efficiency class	A++	A+++	A+++	A+++	

Type		Inverter Heat Pump							
Indoor Unit		MSZ-EF25VG		MSZ-EF35VG		MSZ-EF42VG	MSZ-EF50VG		
Outdoor Unit		MUZ-EF25VG	MUZ-EF25VGH	MUZ-EF35VG	MUZ-EF35VGH	MUZ-EF42VG	MUZ-EF50VG		
Refrigerant		R32 ^(*)							
Cooling	Design load	kW	2.5	2.5	3.5	3.5	4.2	5.0	
	Annual electricity consumption ⁽²⁾	kWh/a	96	96	139	139	186	233	
	SEER		9.1	9.1	8.8	8.8	7.9	7.5	
		Energy efficiency class	A+++	A+++	A+++	A+++	A++	A++	
Heating (Warmer Season)	Design load	kW	1.3 (2°C)	1.3 (2°C)	1.6 (2°C)	1.6 (2°C)	2.1 (2°C)	2.3 (2°C)	
	Declared Capacity	at reference design temperature	kW	1.3 (2°C)	1.3 (2°C)	1.6 (2°C)	1.6 (2°C)	2.1 (2°C)	2.3 (2°C)
		at bivalent temperature	kW	1.3 (2°C)	1.3 (2°C)	1.6 (2°C)	1.6 (2°C)	2.1 (2°C)	2.3 (2°C)
		at operation limit temperature	kW	2.0 (-15°C)	2.0 (-15°C)	2.4 (-15°C)	2.4 (-15°C)	3.4 (-15°C)	3.5 (-15°C)
	Back up heating capacity	kW	0.0 (2°C)	0.0 (2°C)	0.0 (2°C)	0.0 (2°C)	0.0 (2°C)	0.0 (2°C)	
	Annual electricity consumption ⁽²⁾	kWh/a	311	311	398	398	489	595	
SCOP		5.9	5.9	5.6	5.6	6.0	5.4		
		Energy efficiency class	A+++	A+++	A+++	A+++	A+++	A+++	

Type		Inverter Heat Pump					
Indoor Unit		MSZ-BT20VG	MSZ-BT25VG	MSZ-BT35VG	MSZ-BT50VG		
Outdoor Unit		MUZ-BT20VG	MUZ-BT25VG	MUZ-BT35VG	MUZ-BT50VG		
Refrigerant		R32 ^(*)					
Cooling	Design load	kW	2.0	2.5	3.5	5.0	
	Annual electricity consumption ⁽²⁾	kWh/a	86	108	180	265	
	SEER		8.1	8.1	6.8	6.6	
		Energy efficiency class	A++	A++	A++	A++	
Heating (Warmer Season)	Design load	kW	0.9 (2°C)	1.1 (2°C)	1.3 (2°C)	2.1 (2°C)	
	Declared Capacity	at reference design temperature	kW	0.9 (2°C)	1.1 (2°C)	1.3 (2°C)	2.1 (2°C)
		at bivalent temperature	kW	0.9 (2°C)	1.1 (2°C)	1.3 (2°C)	2.1 (2°C)
		at operation limit temperature	kW	1.3 (-15°C)	1.7 (-15°C)	2.1 (-15°C)	3.4 (-15°C)
	Back up heating capacity	kW	0.0 (2°C)	0.0 (2°C)	0.0 (2°C)	0.0 (2°C)	
	Annual electricity consumption ⁽²⁾	kWh/a	234	268	304	543	
SCOP ⁽⁴⁾		5.3	5.7	5.9	5.4		
		Energy efficiency class	A+++	A+++	A+++	A+++	

Type		Inverter Heat Pump							
Indoor Unit		MSZ-HR25VF	MSZ-HR35VF	MSZ-HR42VF	MSZ-HR50VF	MSZ-HR60VF	MSZ-HR71VF		
Outdoor Unit		MUZ-HR25VF	MUZ-HR35VF	MUZ-HR42VF	MUZ-HR50VF	MUZ-HR60VF	MUZ-HR71VF		
Refrigerant		R32 ^(*)							
Cooling	Design load	kW	2.5	3.4	4.2	5.0	6.1	7.1	
	Annual electricity consumption ⁽²⁾	kWh/a	141	191	226	269	296	355	
	SEER		6.2	6.2	6.5	6.5	7.2	7.0	
		Energy efficiency class	A++	A++	A++	A++	A++	A++	
Heating (Warmer Season)	Design load	kW	1.1 (2°C)	1.3 (2°C)	1.6 (2°C)	2.1 (2°C)	2.5 (2°C)	3.0 (2°C)	
	Declared Capacity	at reference design temperature	kW	1.1 (2°C)	1.3 (2°C)	1.6 (2°C)	2.1 (2°C)	2.5 (2°C)	3.0 (2°C)
		at bivalent temperature	kW	1.1 (2°C)	1.3 (2°C)	1.6 (2°C)	2.1 (2°C)	2.5 (2°C)	3.0 (2°C)
		at operation limit temperature	kW	1.9 (-10°C)	2.4 (-10°C)	2.9 (-10°C)	3.8 (-10°C)	4.6 (-10°C)	5.4 (-10°C)
	Back up heating capacity	kW	0.0 (2°C)	0.0 (2°C)	0.0 (2°C)	0.0 (2°C)	0.0 (2°C)	0.0 (2°C)	
	Annual electricity consumption ⁽²⁾	kWh/a	289	344	427	558	640	802	
SCOP		5.3	5.2	5.2	5.2	5.4	5.2		
		Energy efficiency class	A+++	A+++	A+++	A+++	A+++	A+++	

Type		Inverter Heat Pump				
Indoor Unit		MSZ-DW25VF	MSZ-DW35VF	MSZ-DW50VF		
Outdoor Unit		MUZ-DW25VF	MUZ-DW35VF	MUZ-DW50VF		
Refrigerant		R32 ^(*)				
Cooling	Design load	kW	2.5	3.4	5.0	
	Annual electricity consumption ⁽²⁾	kWh/a	135	184	261	
	SEER		6.2	6.2	6.5	
		Energy efficiency class	A++	A++	A++	
Heating (Warmer Season)	Design load	kW	1.1 (2°C)	1.3 (2°C)	2.1 (2°C)	
	Declared Capacity	at reference design temperature	kW	1.1 (2°C)	1.3 (2°C)	2.1 (2°C)
		at bivalent temperature	kW	1.1 (2°C)	1.3 (2°C)	2.1 (2°C)
		at operation limit temperature	kW	1.9 (-10°C)	2.4 (-10°C)	3.8 (-10°C)
	Back up heating capacity	kW	0.0 (2°C)	0.0 (2°C)	0.0 (2°C)	
	Annual electricity consumption ⁽²⁾	kWh/a	287	351	508	
SCOP		5.3	5.1	5.3		
		Energy efficiency class	A+++	A+++	A+++	

(*) Refrigerant leakage contributes to climate change. Refrigerant with lower global warming potential (GWP) would contribute less to global warming than a refrigerant with higher GWP, if leaked to the atmosphere. This appliance contains a refrigerant fluid with a GWP equal to 1975. This means that if 1 kg of this refrigerant fluid would be leaked to the atmosphere, the impact on global warming would be 1975 times higher than 1 kg of CO₂, over a period of 100 years. Never try to interfere with the refrigerant circuit yourself or disassemble the product yourself and always ask a professional.

(2) Energy consumption based on standard test results. Actual energy consumption will depend on how the appliance is used and where it is located.

(3) Refrigerant leakage contributes to climate change. Refrigerant with lower global warming potential (GWP) would contribute less to global warming than a refrigerant with higher GWP, if leaked to the atmosphere. This appliance contains a refrigerant fluid with a GWP equal to 550. This means that if 1 kg of this refrigerant fluid would be leaked to the atmosphere, the impact on global warming would be 550 times higher than 1 kg of CO₂, over a period of 100 years. Never try to interfere with the refrigerant circuit yourself or disassemble the product yourself and always ask a professional.

Specification on Warmer/Colder Condition

Type		Inverter Heat Pump							
Indoor Unit		MSZ-FH25VE2		MSZ-FH35VE2		MSZ-FH50VE2			
Outdoor Unit		MUZ-FH25VE	MUZ-FH25VEHZ	MUZ-FH35VE	MUZ-FH35VEHZ	MUZ-FH50VE	MUZ-FH50VEHZ		
Refrigerant		R410A ⁽¹⁾							
Cooling	Design load	kW	2.5	2.5	3.5	3.5	5.0	5.0	
	Annual electricity consumption ⁽²⁾	kWh/a	96	96	138	138	244	244	
	SEER		9.1	9.1	8.9	8.9	7.2	7.2	
		Energy efficiency class	A+++	A+++	A+++	A+++	A++	A++	
Heating (Warmer Season)	Design load	kW	1.7 (2°C)	1.8 (2°C)	2.0 (2°C)	2.2 (2°C)	2.5 (2°C)	3.3 (2°C)	
	Declared Capacity	at reference design temperature	kW	1.7 (2°C)	1.8 (2°C)	2.0 (2°C)	2.2 (2°C)	2.5 (2°C)	3.3 (2°C)
		at bivalent temperature	kW	1.7 (2°C)	1.8 (2°C)	2.0 (2°C)	2.2 (2°C)	2.5 (2°C)	3.3 (2°C)
		at operation limit temperature	kW	2.5 (-15°C)	1.7 (-25°C)	3.2 (-15°C)	2.6 (-25°C)	5.2 (-15°C)	3.8 (-25°C)
	Back up heating capacity	kW	0.0 (2°C)	0.0 (2°C)	0.0 (2°C)	0.0 (2°C)	0.0 (2°C)	0.0 (2°C)	
	Annual electricity consumption ⁽²⁾	kWh/a	376	397	429	471	614	787	
	SCOP		6.3	6.3	6.5	4.8 / 6.5	5.7	5.9	
		Energy efficiency class	A+++	A+++	A+++	A+++	A+++	A+++	

Type		Inverter Heat Pump									
Indoor Unit		MSZ-SF25VE3		MSZ-SF35VE3		MSZ-SF42VE3		MSZ-SF50VE3			
Outdoor Unit		MUZ-SF25VE	MUZ-SF25VEH	MUZ-SF35VE	MUZ-SF35VEH	MUZ-SF42VE	MUZ-SF42VEH	MUZ-SF50VE	MUZ-SF50VEH		
Refrigerant		R410A ⁽¹⁾									
Cooling	Design load	kW	2.5	2.5	3.5	3.5	4.2	4.2	5.0	5.0	
	Annual electricity consumption ⁽²⁾	kWh/a	116	116	171	171	196	196	246	246	
	SEER		7.6	7.6	7.2	7.2	7.5	7.5	7.2	7.2	
		Energy efficiency class	A++	A++	A++	A++	A++	A++	A++	A++	
Heating (Warmer Season)	Design load	kW	1.3 (2°C)	1.3 (2°C)	1.6 (2°C)	1.6 (2°C)	2.1 (2°C)	2.1 (2°C)	2.3 (2°C)	2.3 (2°C)	
	Declared Capacity	at reference design temperature	kW	1.3 (2°C)	1.3 (2°C)	1.6 (2°C)	1.6 (2°C)	2.1 (2°C)	2.1 (2°C)	2.3 (2°C)	2.3 (2°C)
		at bivalent temperature	kW	1.3 (2°C)	1.3 (2°C)	1.6 (2°C)	1.6 (2°C)	2.1 (2°C)	2.1 (2°C)	2.3 (2°C)	2.3 (2°C)
		at operation limit temperature	kW	2.0 (-15°C)	1.6 (-20°C)	2.2 (-15°C)	1.6 (-20°C)	3.4 (-15°C)	2.2 (-20°C)	3.4 (-15°C)	2.3 (-20°C)
	Back up heating capacity	kW	0.0 (2°C)	0.0 (2°C)	0.0 (2°C)	0.0 (2°C)	0.0 (2°C)	0.0 (2°C)	0.0 (2°C)	0.0 (2°C)	
	Annual electricity consumption ⁽²⁾	kWh/a	337	337	923 / 418	417	507	507	563	563	
	SCOP		5.4	5.4	5.4	5.4	5.8	5.8	5.7	5.7	
		Energy efficiency class	A+++	A+++	A+++	A+++	A+++	A+++	A+++	A+++	

Type		Inverter Heat Pump					
Indoor Unit		MSZ-GF60VE2	MSZ-GF71VE2	MSZ-WN25VA	MSZ-WN35VA		
Outdoor Unit		MUZ-GF60VE	MUZ-GF71VE	MUZ-WN25VA	MUZ-WN35VA		
Refrigerant		R410A ⁽¹⁾					
Cooling	Design load	kW	6.1	7.1	2.5	3.1	
	Annual electricity consumption ⁽²⁾	kWh/a	311	364	141	173	
	SEER		6.8	6.8	6.2	6.2	
		Energy efficiency class	A++	A++	A++	A++	
Heating (Warmer Season)	Design load	kW	2.5 (2°C)	3.7 (2°C)	1.1 (2°C)	1.3 (2°C)	
	Declared Capacity	at reference design temperature	kW	2.5 (2°C)	3.7 (2°C)	1.1 (2°C)	1.3 (2°C)
		at bivalent temperature	kW	2.5 (2°C)	3.7 (2°C)	1.1 (2°C)	1.3 (2°C)
		at operation limit temperature	kW	3.7 (-15°C)	5.4 (-15°C)	1.6 (-15°C)	2.0 (-15°C)
	Back up heating capacity	kW	0.0 (2°C)	0.0 (2°C)	0.0 (2°C)	0.0 (2°C)	
	Annual electricity consumption ⁽²⁾	kWh/a	664	963	304	362	
	SCOP ⁽³⁾		5.3	5.4	5.0	5.0	
		Energy efficiency class	A+++	A+++	A++	A++	

Type		Inverter Heat Pump								
Indoor Unit		MSZ-HJ25VA	MSZ-HJ35VA	MSZ-HJ50VA	MSZ-HJ60VA	MSZ-HJ71VA	MSZ-DM25VA	MSZ-DM35VA		
Outdoor Unit		MUZ-HJ25VA	MUZ-HJ35VA	MUZ-HJ50VA	MUZ-HJ60VA	MUZ-HJ71VA	MUZ-DM25VA	MUZ-DM35VA		
Refrigerant		R410A ⁽¹⁾								
Cooling	Design load	kW	2.5	3.1	5.0	6.1	7.1	2.5	3.1	
	Annual electricity consumption ⁽²⁾	kWh/a	171	212	292	354	441	149	190	
	SEER		5.1	5.1	6.0	6.0	5.6	5.8	5.7	
		Energy efficiency class	A	A	A+	A+	A+	A+	A+	
Heating (Warmer Season)	Design load	kW	1.1 (2°C)	1.3 (2°C)	2.1 (2°C)	2.5 (2°C)	2.9 (2°C)	1.1 (2°C)	1.3 (2°C)	
	Declared Capacity	at reference design temperature	kW	1.1 (2°C)	1.3 (2°C)	2.1 (2°C)	2.5 (2°C)	2.9 (2°C)	1.1 (2°C)	1.3 (2°C)
		at bivalent temperature	kW	1.1 (2°C)	1.3 (2°C)	2.1 (2°C)	2.5 (2°C)	2.9 (2°C)	1.1 (2°C)	1.3 (2°C)
		at operation limit temperature	kW	1.9 (-10°C)	2.4 (-10°C)	3.8 (-10°C)	4.6 (-10°C)	5.4 (-10°C)	1.9 (-10°C)	2.4 (-10°C)
	Back up heating capacity	kW	0.0 (2°C)	0.0 (2°C)	0.0 (2°C)	0.0 (2°C)	0.0 (2°C)	0.0 (2°C)	0.0 (2°C)	
	Annual electricity consumption ⁽²⁾	kWh/a	356	426	539	674	813	325	386	
	SCOP		4.3	4.3	5.5	5.1	4.9	4.7	4.7	
		Energy efficiency class	A+	A+	A+++	A+++	A++	A++	A++	

⁽¹⁾ Refrigerant leakage contributes to climate change. Refrigerant with lower global warming potential (GWP) would contribute less to global warming than a refrigerant with higher GWP, if leaked to the atmosphere. This appliance contains a refrigerant fluid with a GWP equal to 1975. This means that if 1 kg of this refrigerant fluid would be leaked to the atmosphere, the impact on global warming would be 1975 times higher than 1 kg of CO₂ over a period of 100 years. Never try to interfere with the refrigerant circuit yourself or disassemble the product yourself and always ask a professional.

⁽²⁾ Energy consumption based on standard test results. Actual energy consumption will depend on how the appliance is used and where it is located.

⁽³⁾ Refrigerant leakage contributes to climate change. Refrigerant with lower global warming potential (GWP) would contribute less to global warming than a refrigerant with higher GWP, if leaked to the atmosphere. This appliance contains a refrigerant fluid with a GWP equal to 550. This means that if 1 kg of this refrigerant fluid would be leaked to the atmosphere, the impact on global warming would be 550 times higher than 1 kg of CO₂ over a period of 100 years. Never try to interfere with the refrigerant circuit yourself or disassemble the product yourself and always ask a professional.



S

SERIES



SELECTION

Series line-up consists of two types of indoor units.
Choose the model that best matches room conditions.

SELECT INDOOR UNIT

Select the optimal unit and capacity required to match room construction and air conditioning requirements.

R32

R410A



Units without Remote Controller

SLZ-M15FA2
(Multi split series connection only)

SLZ-M25FA2
SLZ-M35FA2
SLZ-M50FA2
SLZ-M60FA2

Panel

Panel	With Signal Receiver	With 3D i-see Sensor	With Wireless Remote Controller	With Plasma Quad Connect
SLP-2FA				
SLP-2FAL	✓			
SLP-2FAE		✓		
SLP-2FALE	✓	✓		
SLP-2FALM2	✓		✓	
SLP-2FALME2	✓	✓	✓	
SLP-2FAP				✓
SLP-2FALP	✓			✓
SLP-2FALMP2	✓		✓	✓

R32

R410A



Units without Remote Controller

SEZ-M25DA2
SEZ-M35DA2
SEZ-M50DA2
SEZ-M60DA2
SEZ-M71DA2

Units with Wireless Remote Controller

SEZ-M25DAL2
SEZ-M35DAL2
SEZ-M50DAL2
SEZ-M60DAL2
SEZ-M71DAL2

R32



Units without Remote Controller

SFZ-M25VA
SFZ-M35VA
SFZ-M50VA
SFZ-M60VA
SFZ-M71VA

SELECT OUTDOOR UNIT

There is one outdoor unit for respective indoor units.

R32



SUZ-M25/35VA

R32



SUZ-M50VA

R32



SUZ-M60/71VA

R410A



SUZ-KA25/35VA6

R410A



SUZ-KA50/60/71VA6

*To confirm compatibility with the MXZ Series multi-type system, refer to the MXZ Series page.

SLZ SERIES

R32
R410A

SLZ-M15/25/35/50/60FA2



Compact, lightweight ceiling cassette units with 4-way air outlets provide maximum comfort by evenly distributing airflow throughout the entire room.

2x2 Cassette Line-up

The SLZ series was previously only able to be connected to standard inverters and some power inverters. However, it can now also be connected to low-capacity power inverters. The ability to connect to a high-performance power inverter allows us to offer a wider range of options to our customers.

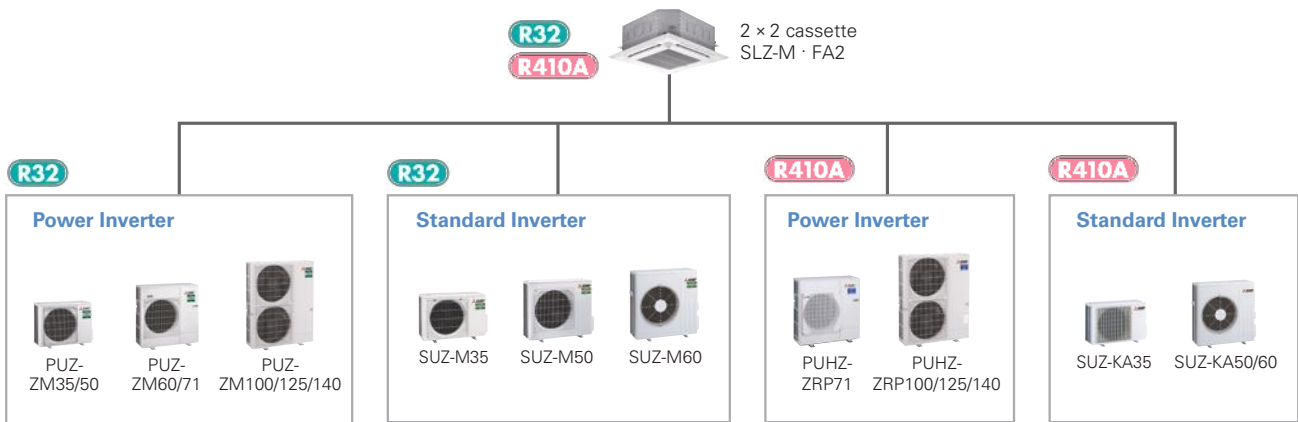

New lineup

1.5kW has been introduced for multi connection. The diverse selection enables the best solution for both customer and location.

Capacity	15	25	35	50	60
SLZ-KF		✓	✓	✓	✓
SLZ-M	✓	✓	✓	✓	✓

Beautiful design

The straight-line form introduced has resulted in a beautiful square design. Its high affinity ensures the ability to blend in seamlessly with any interior. The indoor unit is an ideal match for office or store use. Of course, design matched 2x2 (600mm*600mm) ceiling construction specifications.

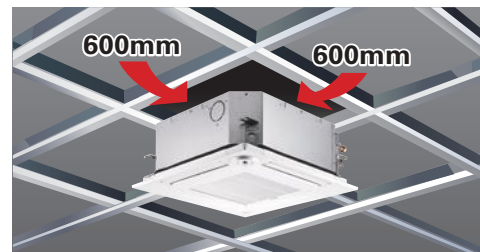

The height above ceiling of 245mm

The height above ceiling of 245mm enables fitting into narrow ceiling space. Installation is simple, even when the ceiling spaces are narrow to make the ceilings higher. Of course, in addition to our products, replacing competitors' product is simplified too.

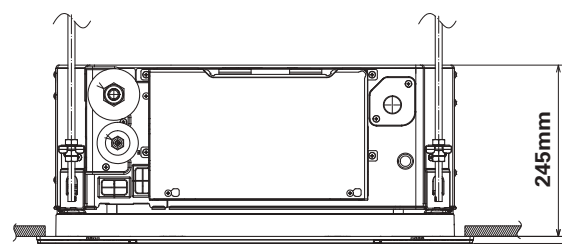

Energy-saving Performance*

The energy-saving performance achieved A++ in SEER and A+ in SCOP.

*In case of connecting with SUZ-KA-VA6

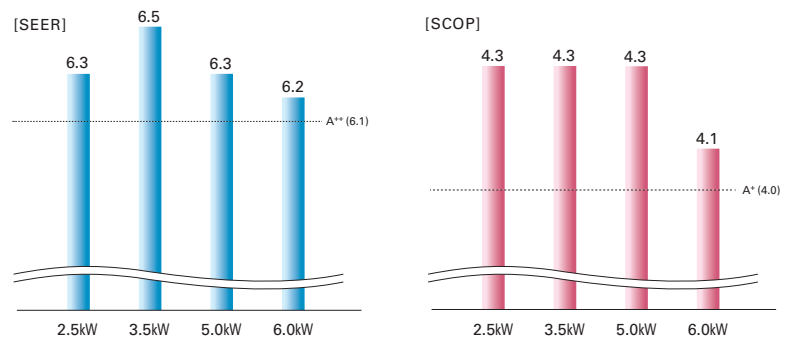

Quietness

Low sound level has been realized by introduction of 3D turbo fan. New SLZ can give users quieter and more comfortable room condition.



Horizontal Airflow

The new airflow control completely eliminates that uncomfortable drafty-feeling with the introduction of a horizontal airflow that spreads across the ceiling. The ideal airflow for offices and restaurants.

[Airflow distribution]*
SLZ-M60FA
Flow angle, cooling at 20°C (ceiling height 2.7m)

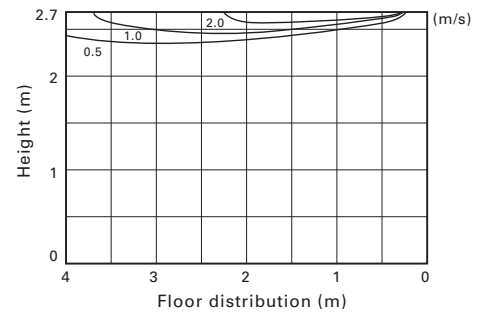

*Vane angle: Horizontal

Easy installation

Temporary hanging hook

The structure of the panel has been revised and is now equipped with a temporary hanging hook. This has improved work efficiency during temporary panel installation.



No need to remove screws

Installation is possible without removing the screws for control box simply loosen them. This eliminates the risk of losing screws.

■ Corner panel

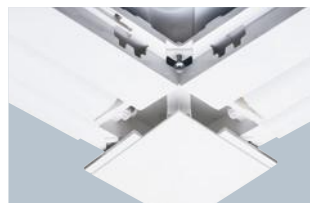

■ Control box cover



Drain lift

As the result of using a larger drain pan, the maximum drain lifting height has been up to 850mm, greatly enhancing construction flexibility compared to the existing model.

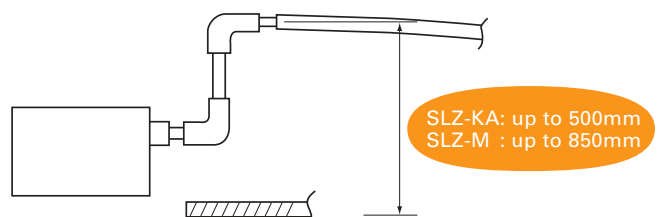

Detects number of people

Room occupancy energy-saving mode

The 3D i-see Sensor detects the number of people in the room. It then calculates the occupancy rate based on the maximum number of people in the room up to that point in time in order to save air-conditioning power. When the occupancy rate is approximately 30%, air-conditioning power equivalent to 1°C during both cooling and heating operation is saved. The temperature is controlled according to the number of people.

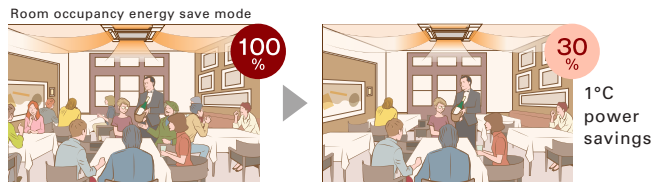

No occupancy energy-saving mode

When 3D i-see Sensor detects that no one is in the room, the system is switched to a pre-set power-saving mode. If the room remains unoccupied for more than 60min, air-conditioning power equivalent to 2°C during both cooling and heating operation is saved. This contributes to preventing waste in terms of heating and cooling.

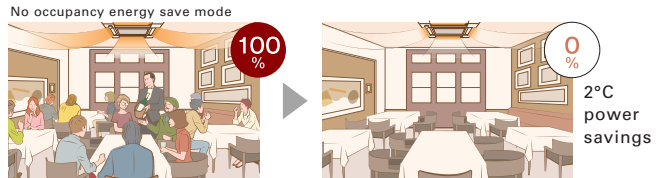

No occupancy Auto-OFF mode*

When the room remains unoccupied for a pre-set period of time, the air conditioner turns off automatically, thereby providing even greater power savings. The time until operation is stopped can be set in intervals of 10min, ranging from 60 to 180 min.

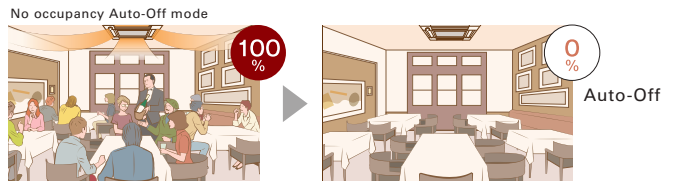

* When MA Remote Controller is used to control multiple refrigerant systems, "No occupancy Auto-OFF mode" cannot be used.

*PAR-41MAA is required for each setting

Detects people's position

Direct/Indirect settings*

Some people do not like the feel of wind, some want to be warm from head to toe. People's likes and dislikes vary. With the 3D i-see Sensor, it is possible to choose to block or not block to the wind for each vane.

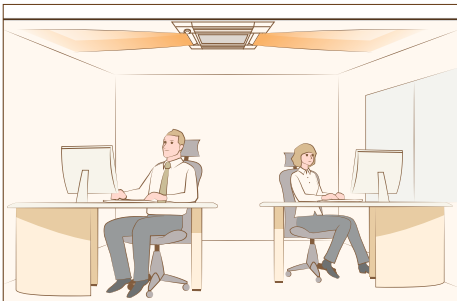

*PAR-41MAA or PAR-SL101A-E is required for each setting.

Seasonal airflow*

<When cooling>

Saves energy while keeping a comfortable effective temperature by automatically switching between ventilation and cooling. When a pre-set temperature is reached, the air conditioning unit switches to swing fan operation to maintain the effective temperature. This clever function contributes to keeping a comfortable coolness.

<When heating>

The air conditioning unit automatically switches between circulator and heating. Wasted heat that accumulates near the ceiling is reused via circulation. When a pre-set temperature is reached the air conditioner switches from heating to circulator and blows air in the horizontal direction. It pushes down the warm air that has gathered near the ceiling to people's height, thereby providing smart heating.

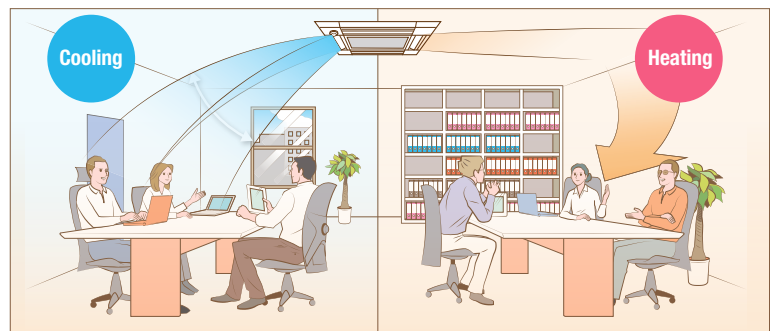

*PAR-41MAA is required for each setting.

Connectable to Plasma Quad Connect

The optional Plasma Quad Connect SLP-2FAP, SLP-2FALP, SLP-2FALMP2 can be installed on the indoor units.*1*2*3

*1 Plasma Quad Connect cannot be used with PAC-SK54/46KF-E (V blocking filter).

*2 If Plasma Quad Connect is used with MAC-334/397/5871F-E (Interface), Plasma Quad Connect use the indoor units CN105. Other interface use the another CN105 on Plasma Quad Connect's PCB.

*3 If Plasma Quad Connect is used with PAC-SK35VK-E (Valve kit) or PAC-SK39AP-E (Valve kit attachment), Plasma Quad Connect use the indoor units barring holes for valve kit. Valve kit needs to be installed on suspension bolts or on horizontal surface using dedicated attachment optional parts.



SLZ-M SERIES



Indoor Unit

R32
R410A



SLZ-M15/25/35/50/60FA2

Panel

Panel	With Signal Receiver	With 3D i-see Sensor	With Wireless Remote Controller	With Plasma Quad Connect
SLP-2FA				
SLP-2FAL	✓			
SLP-2FAE		✓		
SLP-2FALE	✓	✓		
SLP-2FALM2	✓		✓	
SLP-2FALME2	✓	✓	✓	
SLP-2FAP				✓
SLP-2FALP	✓			✓
SLP-2FALMP2	✓		✓	✓

Outdoor Unit

R32 For Single

R32 For Multi (Twin/Triple/Quadruple)



Remote Controller



Indoor Unit Combination	Outdoor Unit Capacity														
	For Single							For Twin			For Triple		For Quadruple		
	35	50	60	71	100	125	140	71	100	125	100	125	140	125	140
Power Inverter (PUZ-ZM)	35x1	50x1	60x1	-	-	-	-	35x2	50x2	60x2	35x3	50x3	50x3	35x4	35x4
Distribution Pipe	-	-	-	-	-	-	-	MSDD-50TR2-E			MSDF-111R3-E		MSDF-111R2-E		

Type			Inverter Heat Pump			
Indoor Unit			SLZ-M35FA2		SLZ-M50FA2	
Outdoor Unit			PUZ-ZM35VKA2		PUZ-ZM50VKA2	
Refrigerant ⁽¹⁾			R32			
Power Supply	Source		Outdoor power supply			
Cooling	Outdoor(V/Phase/Hz)		230/Single/50			
	Capacity	Rated	kW	3.6	5.0	6.1
		Min-Max	kW	1.6 - 4.5	2.3 - 5.6	2.7 - 6.5
	Total Input	Rated	kW	0.800	1.315	1.648
	EER			4.50	3.80	3.70
	Design load		kW	3.6	5.0	6.1
	Annual electricity consumption ⁽²⁾		kWh/a	194	280	346
SEER ⁽⁴⁾			6.5	6.2	6.1	
Heating	Energy efficiency class		A++			
	Capacity	Rated	kW	4.1	5.0	6.4
		Min-Max	kW	1.6 - 5.0	2.5 - 5.5	2.8 - 7.3
	Total Input	Rated	kW	1.205	1.470	2.064
	COP			3.40	3.40	3.10
	Design load		kW	2.4	3.8	4.4
	Declared Capacity	at reference design temperature	kW	2.4 (-10°C)	3.8 (-10°C)	4.4 (-10°C)
		at bivalent temperature	kW	2.4 (-10°C)	3.8 (-10°C)	4.4 (-10°C)
		at operation limit temperature	kW	2.2 (-11°C)	3.7 (-11°C)	2.8 (-20°C)
	Back up heating capacity		kW	0.0	0.0	0.0
Annual electricity consumption ⁽²⁾		kWh/a	820	1273	1560	
SCOP ⁽⁴⁾			4.0	4.1	3.9	
Energy efficiency class		A+				
Operating Current(Max)		A	13.2	13.3	19.4	
Indoor Unit	Input [cooling / Heating]	Rated	kW	0.02 / 0.02	0.03 / 0.03	0.04 / 0.04
	Operating Current(Max)		A	0.24	0.32	0.43
	Dimensions	H*W*D	mm	245-570-570 <10-625-625>	245-570-570 <10-625-625>	245-570-570 <10-625-625>
	Weight		kg	15 <3>	15 <3>	15 <3>
	Air Volume (Lo-Mi2-Mi1-Hi)		m³/min	6.5-8.0-9.5	7.0-9.0-11.5	7.5-11.5-13.0
	Sound Level (Lo-Mi2-Mi1-Hi) (SPL)		dB(A)	25-30-34	27-34-39	32-40-43
	Sound Level (PWL)		dB(A)	51	56	60
Outdoor Unit	Dimensions	H*W*D	mm	630-809-300	630-809-300	943-950-330(+25)
	Weight		kg	46	46	67
	Air Volume	Cooling	m³/min	45	45	55
		Heating	m³/min	45	45	55
	Sound Level (SPL)	Cooling	dB(A)	44	44	47
		Heating	dB(A)	46	46	49
	Sound Level (PWL)	Cooling	dB(A)	65	65	67
Operating Current(Max)		A	13	13	19	
Breaker Size		A	16	16	25	
Ext. Piping	Diameter ⁽³⁾	Liquid/Gas	mm	6.35 / 12.7	6.35 / 12.7	9.52 / 15.88
	Max.Length	Out-In	m	50	50	55
	Max.Height	Out-In	m	30	30	30
Guaranteed Operating Range (Outdoor)	Cooling ⁽²⁾	°C	-15 ~ +46	-15 ~ +46	-15 ~ +46	
	Heating	°C	-11 ~ +21	-11 ~ +21	-20 ~ +21	

*1 Refrigerant leakage contributes to climate change. Refrigerant with lower global warming potential (GWP) would contribute less to global warming than a refrigerant with higher GWP, if leaked to the atmosphere. This appliance contains a refrigerant fluid with a GWP equal to 1975. This means that if 1 kg of this refrigerant fluid would be leaked to the atmosphere, the impact on global warming would be 1975 times higher than 1 kg of CO₂ over a period of 100 years. Never try to interfere with the refrigerant circuit yourself or disassemble the product yourself and always ask a professional. The GWP of R410A is 2088 in the IPCC 4th Assessment Report.

*2 Energy consumption based on standard test results. Actual energy consumption will depend on how the appliance is used and where it is located.

*3 Optional air protection guide is required where ambient temperature is lower than -5°C.

*4 SEER and SCOP are based on 2009/125/EC:Energy-related Products Directive and Regulation(EU) No206/2012.

*5 Joint pipe is required depending on installed refrigerant pipes, outdoor units and indoor units.

SLZ-M SERIES



Indoor Unit

R32
R410A



SLZ-M15/25/35/50/60FA2

Panel

Panel	With Signal Receiver	With 3D i-see Sensor	With Wireless Remote Controller	With Plasma Quad Connect
SLP-2FA				
SLP-2FAL	✓			
SLP-2FAE		✓		
SLP-2FALE	✓	✓		
SLP-2FALM2	✓		✓	
SLP-2FALME2	✓	✓	✓	
SLP-2FAP				✓
SLP-2FALP	✓			✓
SLP-2FALMP2	✓		✓	✓

Outdoor Unit

For Single



Remote Controller



Indoor Unit Combination	Outdoor Unit Capacity				
	25	35	50	60	71
S Seires	25x1	35x1	50x1	60x1	-
Distribution Pipe	-	-	-	-	-

Type	Inverter Heat Pump							
Indoor Unit	SLZ-M25FA2	SLZ-M35FA2	SLZ-M50FA2	SLZ-M60FA2				
Outdoor Unit	SUZ-M25VA	SUZ-M35VA	SUZ-M50VA	SUZ-M60VA				
Refrigerant ⁽¹⁾	R32							
Power Supply	Outdoor power supply							
Source	230/Single/50							
Outdoor(V/Phase/Hz)								
Cooling	Capacity	Rated	kW	2.5	3.5	4.6	5.7	
		Min-Max	kW	1.4 - 3.2	0.7 - 3.9	1.0 - 5.2	1.5 - 6.3	
	Total Input	Rated	kW	0.657	1.093	1.352	1.676	
	EER			3.80	3.20	3.40	3.40	
	Design load		kW	2.5	3.5	4.6	5.7	
	Annual electricity consumption ⁽²⁾		kWh/a	139	183	253	321	
	SEER ⁽⁴⁾			6.3	6.7	6.3	6.2	
		Energy efficiency class		A++	A++	A++	A++	
		Capacity	Rated	kW	3.2	4.0	5.0	6.4
			Min-Max	kW	1.3 - 4.2	1.0 - 5.0	1.3 - 5.5	1.6 - 7.3
Heating	Total Input	Rated	kW	0.886	1.078	1.562	2.133	
	COP			3.61	3.71	3.20	3.00	
	Design load		kW	2.2	2.6	3.6	4.6	
	Declared Capacity		at reference design temperature	kW	2.0 (-10°C)	2.3 (-10°C)	3.2 (-10°C)	4.1 (-10°C)
			at bivalent temperature	kW	2.0 (-7°C)	2.3 (-7°C)	3.2 (-7°C)	4.1 (-7°C)
			at operation limit temperature	kW	2.0 (-10°C)	2.3 (-10°C)	3.2 (-10°C)	4.1 (-10°C)
	Back up heating capacity		kW	0.2	0.3	0.4	0.5	
	Annual electricity consumption ⁽²⁾		kWh/a	716	845	1192	1560	
	SCOP ⁽⁴⁾			4.3	4.3	4.2	4.1	
		Energy efficiency class		A+	A+	A+	A+	
Operating Current(Max)		A		7.0	8.7	13.8	15.2	
Indoor Unit	Input [cooling / Heating]	Rated	kW	0.02 / 0.02	0.02 / 0.02	0.03 / 0.03	0.04 / 0.04	
	Operating Current(Max)		A	0.20	0.24	0.32	0.43	
	Dimensions	H*W*D	mm	245-570-570 <10-625-625>	245-570-570 <10-625-625>	245-570-570 <10-625-625>	245-570-570 <10-625-625>	
	Weight		kg	15 <3>	15 <3>	15 <3>	15 <3>	
	Air Volume (Lo-Mi2-Mi1-Hi)		m³/min	6.5-7.5-8.5	6.5-8.0-9.5	7.0-9.0-11.5	7.5-11.5-13.0	
	Sound Level (Lo-Mi2-Mi1-Hi) (SPL)		dB(A)	25-28-31	25-30-34	27-34-39	32-40-43	
	Sound Level (PWL)		dB(A)	48	51	56	60	
	Outdoor Unit	Dimensions	H*W*D	mm	550-800-285	550-800-285	714-800-285	880-840-330
		Weight		kg	30	35	41	54
		Air Volume	Cooling	m³/min	36.3	34.3	45.8	50.1
Heating			m³/min	34.6	32.7	43.7	50.1	
Sound Level (SPL)		Cooling	dB(A)	45	48	48	49	
		Heating	dB(A)	46	48	49	51	
Sound Level (PWL)		Cooling	dB(A)	59	59	64	65	
		Heating	dB(A)	59	59	64	65	
Operating Current(Max)			A	6.8	8.5	13.5	14.8	
Breaker Size			A	10	10	20	20	
Ext.Piping	Diameter ⁽⁵⁾	Liquid/Gas	mm	6.35 / 9.52	6.35 / 9.52	6.35 / 12.7	6.35 / 15.88	
	Max.Length	Out-In	m	20	20	30	30	
	Max.Height	Out-In	m	12	12	30	30	
Guaranteed Operating Range (Outdoor)	Cooling ⁽³⁾	°C		-10 ~ +46	-10 ~ +46	-15 ~ +46	-15 ~ +46	
	Heating	°C		-10 ~ +24	-10 ~ +24	-10 ~ +24	-10 ~ +24	

*1 Refrigerant leakage contributes to climate change. Refrigerant with lower global warming potential (GWP) would contribute less to global warming than a refrigerant with higher GWP, if leaked to the atmosphere. This appliance contains a refrigerant fluid with a GWP equal to 1975. This means that if 1 kg of this refrigerant fluid would be leaked to the atmosphere, the impact on global warming would be 1975 times higher than 1 kg of CO₂ over a period of 100 years. Never try to interfere with the refrigerant circuit yourself or disassemble the product yourself and always ask a professional. The GWP of R410A is 2088 in the IPCC 4th Assessment Report.
*2 Energy consumption based on standard test results. Actual energy consumption will depend on how the appliance is used and where it is located.
*3 SEER and SCOP are based on 2009/125/EC: Energy-related Products Directive and Regulation (EU) No206/2012.
*4 Joint pipe is required depending on installed refrigerant pipes, outdoor units and indoor units.

SLZ-M SERIES



Indoor Unit

R32
R410A



SLZ-M15/25/35/50/60FA2

Panel

Panel	With Signal Receiver	With 3D i-see Sensor	With Wireless Remote Controller	With Plasma Quad Connect
SLP-2FA				
SLP-2FAL	✓			
SLP-2FAE				
SLP-2FALE	✓	✓		
SLP-2FALM2	✓		✓	
SLP-2FALME2	✓	✓	✓	
SLP-2FAP				✓
SLP-2FALP	✓			✓
SLP-2FALMP2	✓		✓	✓

Outdoor Unit

R410A For Single

R410A For Multi (Twin/Triple/Quadruple)



SUZ-KA25/35VA6

SUZ-KA50/60VA6

PUHZ-ZRP71

PUHZ-ZRP100/125/140

Remote Controller



Indoor Unit Combination	Outdoor Unit Capacity															
	For Single								For Twin			For Triple			For Quadruple	
	25	35	50	60	71	100	125	140	71	100	125	100	125	140	125	140
Power Inverter (PUZ-ZM)	25x1	35x1	50x1	60x1	-	-	-	-	35x2	50x2	60x2	35x3	50x3	50x3	35x4	35x4
Distribution Pipe	-	-	-	-	-	-	-	-	MSDD-50TR-E			MSDT-111R-E			MSDF-1111R-E	

Type	Inverter Heat Pump															
Indoor Unit	SLZ-M25FA2				SLZ-M35FA2				SLZ-M50FA2				SLZ-M60FA2			
Outdoor Unit	SUZ-KA25VA6				SUZ-KA35VA6				SUZ-KA50VA6				SUZ-KA60VA6			
Refrigerant ⁽¹⁾	R410A															
Power Supply	Outdoor power supply 230V/Single/50															
Cooling	Source	Outdoor(V/Phase/Hz)														
	Capacity	Rated	kW		2.6		3.5		4.6		5.6					
		Min-Max	kW		1.5 - 3.2		1.4 - 3.9		2.3 - 5.2		2.3 - 6.5					
	Total Input	Rated	kW		0.684		0.972		1.394		1.767					
	EER	Rated			3.80		3.60		3.30		3.17					
	Design load		kW		2.6		3.5		4.6		5.6					
	Annual electricity consumption ⁽²⁾		kWh/a		144		188		256		316					
SEER ⁽³⁾				6.3		6.5		6.3		6.2						
Heating	Energy efficiency class															
	Capacity	Rated	kW		3.2		4.0		5.0		6.4					
		Min-Max	kW		1.3 - 4.2		1.7 - 5.0		1.7 - 6.0		2.5 - 7.4					
	Total Input	Rated	kW		0.886		1.108		1.558		2.278					
	COP	Rated			3.61		3.61		3.21		2.81					
	Design load		kW		2.2		2.6		3.6		4.6					
	Declared Capacity		at reference design temperature	kW		2.0 (-10°C)		2.3 (-10°C)		3.2 (-10°C)		4.0 (-10°C)				
			at bivalent temperature	kW		2.0 (-7°C)		2.3 (-7°C)		3.2 (-7°C)		4.0 (-7°C)				
			at operation limit temperature	kW		2.0 (-10°C)		2.3 (-10°C)		3.2 (-10°C)		4.0 (-10°C)				
	Back up heating capacity		kW		0.2		0.3		0.4		0.6					
Annual electricity consumption ⁽²⁾		kWh/a		716		846		1166		1573						
SCOP ⁽⁴⁾				4.3		4.3		4.3		4.0						
Operating Current(Max)	Energy efficiency class															
			A		7.2		8.4		12.3		14.4					
Indoor Unit	Input [cooling / Heating]	Rated	kW		0.02 / 0.02		0.02 / 0.02		0.03 / 0.03		0.04 / 0.04					
	Operating Current(Max)		A		0.20		0.24		0.32		0.43					
	Dimensions	H*W*D	mm				245-570-570 <10-625-625>				245-570-570 <10-625-625>					
	Weight		kg		15 <3>		15 <3>		15 <3>		15 <3>					
	Air Volume (Lo-Mi2-Mi1-Hi)		m³/min		6.5-7.5-8.5		6.5-8.0-9.5		7.0-9.0-11.5		7.5-11.5-13.0					
	Sound Level (Lo-Mi2-Mi1-Hi) (SPL)		dB(A)		25-28-31		25-30-34		27-34-39		32-40-43					
	Sound Level (PWL)		dB(A)		48		51		56		60					
	Outdoor Unit	Dimensions	H*W*D	mm				550-800-285				550-800-285				
		Weight		kg		30		35		54		50				
		Air Volume	Cooling	m³/min		32.6		36.3		44.6		40.9				
Heating			m³/min		34.7		34.8		44.6		49.2					
Sound Level (SPL)		Cooling	dB(A)		47		49		52		55					
	Heating	dB(A)		48		50		52		55						
Sound Level (PWL)	Cooling	dB(A)		58		62		65		65						
Operating Current(Max)		A		7		8.2		12		14						
Breaker Size		A		10		10		20		20						
Ext.Piping Diameter ⁽⁵⁾	Liquid/Gas	mm		6.35 / 9.52		6.35 / 9.52		6.35 / 12.7		6.35 / 15.88						
	Max.Length	Out-In	m		20		20		30		30					
	Max.Height	Out-In	m		12		12		30		30					
Guaranteed Operating Range (Outdoor)	Cooling ⁽²⁾	°C		-10 ~ +46		-10 ~ +46		-15 ~ +46		-15 ~ +46						
	Heating	°C		-10 ~ +24		-10 ~ +24		-10 ~ +24		-10 ~ +24						

*1 Refrigerant leakage contributes to climate change. Refrigerant with lower global warming potential (GWP) would contribute less to global warming than a refrigerant with higher GWP, if leaked to the atmosphere. This appliance contains a refrigerant fluid with a GWP equal to 1975. This means that if 1 kg of this refrigerant fluid would be leaked to the atmosphere, the impact on global warming would be 1975 times higher than 1 kg of CO₂ over a period of 100 years. Never try to interfere with the refrigerant circuit yourself or disassemble the product yourself and always ask a professional. The GWP of R410A is 2088 in the IPCC 4th Assessment Report.
 *2 Energy consumption based on standard test results. Actual energy consumption will depend on how the appliance is used and where it is located.
 *3 SEER and SCOP are based on 2009/125/EC: Energy-related Products Directive and Regulation(EU) No206/2012.
 *4 Joint pipe is required depending on installed refrigerant pipes, outdoor units and indoor units.

SEZ SERIES



SEZ-M25-71DA(L)2



This concealed ceiling-mounted indoor unit series is compact, and fits easily into rooms with lowered ceilings. Highly reliable energy-saving performance makes it a best match choice for concealed unit installations.

High Energy Efficiency



Highly efficient indoor units with DC inverter contribute to a reduction in electricity consumption throughout a year. The SEZ series has achieved energy-saving performance of "A+" or higher when connected to PUZ series and "A" or higher when connected to SUZ-M series.

Power Inverter

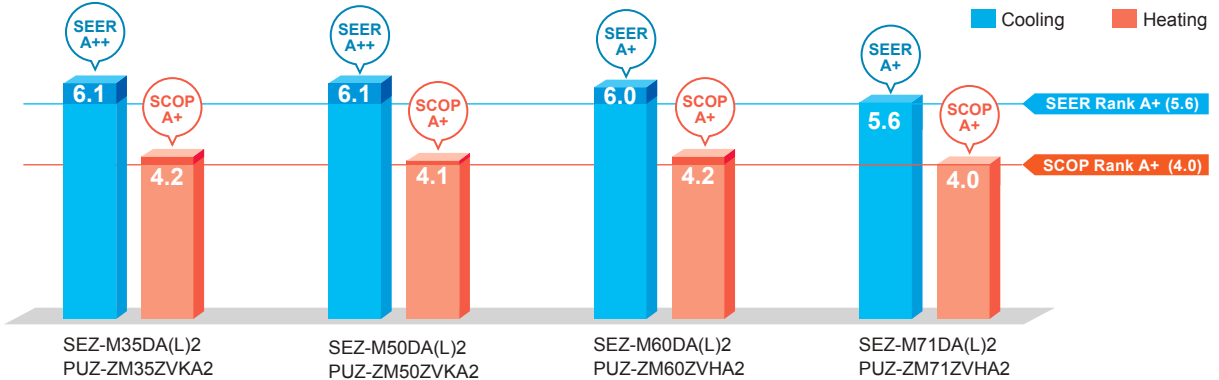

Standard Inverter (R32)

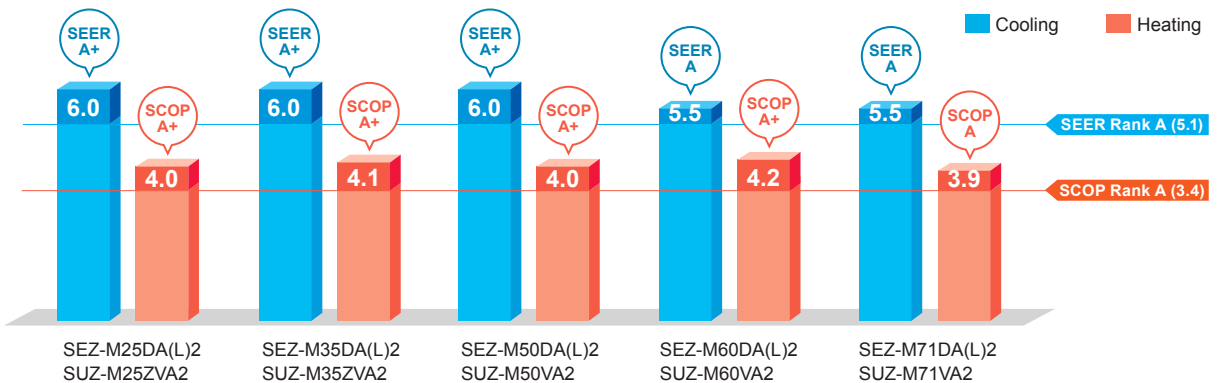

Lineup of compatible outdoor unit has been expanded by power inverter series

Although models in the SEZ series were previously only compatible with the standard inverter, they can now also be connected to small capacity power inverters. The ability to connect to a power inverter with high-performance specifications makes it possible to offer an even wider range of solutions to our customers.

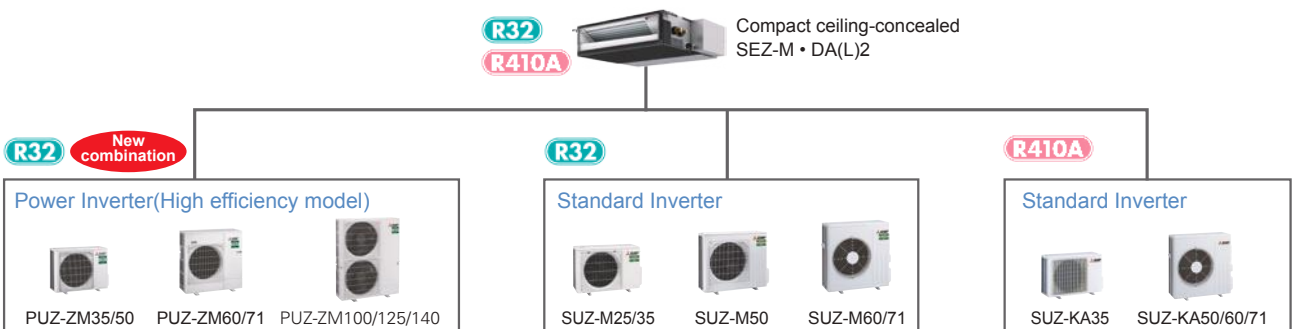

Compact Design with a Height of 200 mm

The height of the units is 200 mm for all capacity ranges. Its thin body is suitable for installation in low ceilings with a small cavity space.

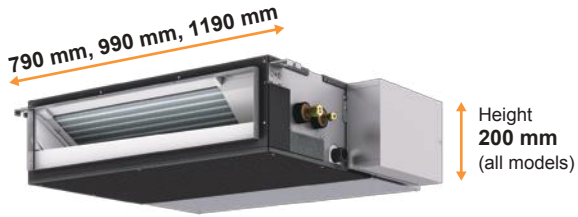

SEZ-M DA(L)2		M25	M35	M50	M60	M71
Height	mm	200				
Width	mm	790	990	1190		

Low Noise Operation

Low noise operation contributes to a peaceful indoor environment. The SPL of M25/35 model, which is the quietest model among the new series, is as low as 22 dB (ESP 5 Pa, low fan speed setting).

		Capacity	M25	M35	M50	M60	M71
Sound pressure level	Fan speed	High	29	30	36	37	39
		Mid	25	26	33	33	34
		Low	22	22	29	29	29

*When fan speed setting is low, the cooling/heating capacity is subject to reduce.

*Operation noise may increase due to the installation environment or the operation status.

Selectable Static Pressure Levels

External static pressure can be selected from 5, 25, 35, and 50 Pa (set to 25 Pa at the time of factory shipment).

Four levels Available for All Models

Drain Pump (Optional)

The PAC-KE07DM-E drain pump is available as an option. The drain connection can be raised as high as 580 mm, allowing more freedom in piping layout design.

*The use of drain pump may increase the operation noise.

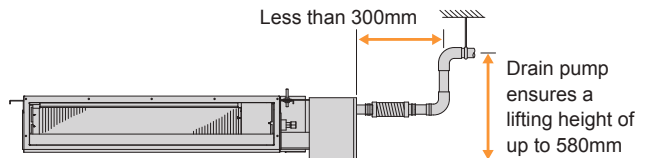

Connectable to Plasma Quad Connect

The optional Plasma Quad Connect MAC-100FT-E can be installed on the indoor unit's air inlet side. For installation, PQ attachment PAC-HA11PAR is required.

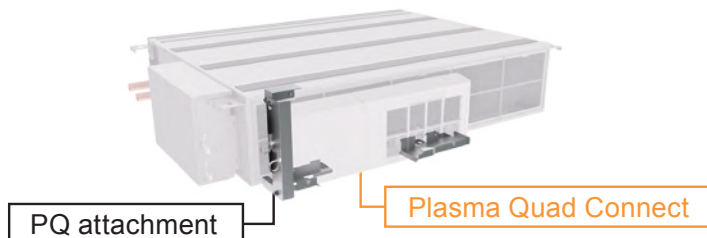

SEZ-M SERIES



Indoor Unit

R32
R410A



SEZ-M25/35/50/60/71DA2 (Requires Wired Remote Controller)
SEZ-M25/35/50/60/71DAL2 (Wireless Remote Controller is enclosed)

Outdoor Unit

R32 For Single

R32 For Multi (Twin/Triple/Quadruple)



PUZ-ZM35/50



PUZ-ZM60/71



PUZ-ZM71



PUZ-ZM100/125/140

Remote Controller



Enclosed in SEZ-M DAL2



*optional (for SEZ-M DA2)



*optional (for SEZ-M DA2)



*optional (for SEZ-M DA2)



Indoor Unit Combination	Outdoor Unit Capacity														
	For Single							For Twin			For Triple			For Quadruple	
	35	50	60	71	100	125	140	71	100	125	100	125	140	125	140
Power Inverter (PUZ-ZM)	35x1	50x1	60x1	71x1	-	-	-	35x2	50x2	60x2	35x3	50x3	50x3	35x4	35x4
Distribution Pipe	-	-	-	-	-	-	-	MSDD-50TR2-E			MSDT-111R3-E			MSDF-1111R2-E	

Type	Inverter Heat Pump															
Indoor Unit	SEZ-M35DA(L)2				SEZ-M50DA(L)2				SEZ-M60DA(L)2				SEZ-M71DA(L)2			
Outdoor Unit	PUZ-ZM35VKA2				PUZ-ZM50VKA2				PUZ-ZM60VHA2				PUZ-ZM71VHA2			
Refrigerant ^(*)	R32															
Power Source	Outdoor power supply															
Supply	230/Single/50															
Cooling	Capacity	Rated	kW	3.6	5.0	6.1	7.1									
		Min-Max	kW	1.6 - 3.9	2.3 - 5.6	2.7 - 6.3	3.3 - 8.1									
	Total Input	Rated	kW	0.857	1.315	1.525	1.918									
	EER ⁽⁴⁾			4.20	3.80	4.00	3.70									
	Design load		kW	3.6	5.0	6.1	7.1									
	Annual electricity consumption ⁽²⁾		kWh/a	205	287	352	440									
	SEER ⁽⁴⁾⁽⁵⁾			6.1	6.1	6.0	5.6									
Heating				Energy efficiency class												
	Capacity	Rated	kW	4.1	6.0	7.0	8.0									
		Min-Max	kW	1.6 - 5.0	2.5 - 7.2	2.8 - 8.0	3.5 - 10.2									
	Total Input	Rated	kW	1.025	1.578	1.707	2.051									
	COP ⁽⁴⁾			4.00	3.80	4.10	3.90									
	Design load		kW	2.4	3.8	4.4	4.7									
	Declared Capacity		at reference design temperature	kW	2.4 (-10°C)	3.8 (-10°C)	4.4 (-10°C)	4.7 (-10°C)								
			at bivalent temperature	kW	2.4 (-10°C)	3.8 (-10°C)	4.4 (-10°C)	4.7 (-10°C)								
			at operation limit temperature	kW	2.2 (-11°C)	3.7 (-11°C)	2.8 (-20°C)	3.5 (-20°C)								
	Back up heating capacity		kW	0.0	0.0	0.0	0.0									
Annual electricity consumption ⁽²⁾		kWh/a	791	1279	1464	1633										
SCOP ⁽⁴⁾⁽⁵⁾			4.2	4.1	4.2	4.0										
			Energy efficiency class													
Operating Current(Max)		A	13.7	13.8	19.9	20.0										
Indoor Unit	Input [cooling / Heating]	Rated	kW	0.047	0.077	0.084	0.102									
	Operating Current(Max)		A	0.65	0.82	0.88	1.00									
	Dimensions	H*W*D	mm	200 - 990 - 700	200 - 990 - 700	200 - 1190 - 700	200 - 1190 - 700									
	Weight		kg	22	22	25.5	25.5									
	Air Volume (Lo-Mid-Hi)		m³/min	7 - 9 - 11	10 - 12.5 - 15	12 - 15 - 18	12 - 16 - 20									
	External Static Pressure ⁽⁷⁾		Pa	<5> - 25 - <35> - <50>	<5> - 25 - <35> - <50>	<5> - 25 - <35> - <50>	<5> - 25 - <35> - <50>									
	Sound Level (Lo-Mid-Hi) (SPL)	Rated	dB(A)	23 - 27 - 31	30 - 34 - 37	30 - 34 - 38	30 - 35 - 40									
		5Pa ⁽⁸⁾	dB(A)	22 - 26 - 30	29 - 33 - 36	29 - 33 - 37	29 - 34 - 39									
			dB(A)	51	57	58	60									
	Outdoor Unit	Dimensions	H*W*D	mm	630-809-300	630-809-300	943-950-330(+25)	943-950-330(+25)								
Weight			kg	46	46	67	67									
Air Volume		Cooling	m³/min	45	45	55	55									
		Heating	m³/min	45	45	55	55									
Sound Level (SPL)		Cooling	dB(A)	44	44	47	47									
		Heating	dB(A)	46	46	49	49									
Sound Level (PWL)		Cooling	dB(A)	65	65	67	67									
		Heating	dB(A)	65	65	67	67									
Operating Current(Max)			A	13	13	19	19									
Breaker Size			A	16	16	25	25									
Ext. Piping	Diameter ⁽⁶⁾	Liquid/Gas	mm	6.35 / 12.7	6.35 / 12.7	9.52 / 15.88	9.52 / 15.88									
	Max.Length	Out-In	m	50	50	55	55									
	Max.Height	Out-In	m	30	30	30	30									
Guaranteed Operating Range (Outdoor)	Cooling ⁽²⁾	°C	-15 ~ +46	-15 ~ +46	-15 ~ +46	-15 ~ +46										
	Heating	°C	-11 ~ +21	-11 ~ +21	-20 ~ +21	-20 ~ +21										

*1 Refrigerant leakage contributes to climate change. Refrigerant with lower global warming potential (GWP) would contribute less to global warming than a refrigerant with higher GWP, if leaked to the atmosphere. This appliance contains a refrigerant fluid with a GWP equal to 550. This means that if 1 kg of this refrigerant fluid would be leaked to the atmosphere, the impact on global warming would be 550 times higher than 1 kg of CO₂ over a period of 100 years. Never try to interfere with the refrigerant circuit yourself or disassemble the product yourself and always ask a professional. The GWP of R32 is 675 in the IPCC 4th Assessment Report.

*2 Energy consumption based on standard test results. Actual energy consumption will depend on how the appliance is used and where it is located.

*3 Optional air protection guide is required where ambient temperature is lower than -5°C.

*4 EER/COP and SEER/SCOP for M35-71 are measured at ESP 25Pa

*5 SEER and SCOP are based on 2009/125/EC:Energy-related Products Directive and Regulation(EU) No206/2012.

*6 Joint pipe is required depending on installed refrigerant pipes, outdoor units and indoor units.

*7 The factory setting of ESP is shown without < >.

*8 SPL measured at ESP 5Pa.

SEZ-M SERIES



Indoor Unit

R32
R410A



SEZ-M25/35/50/60/71DA2 (Requires Wired Remote Controller)
SEZ-M25/35/50/60/71DAL2 (Wireless Remote Controller is enclosed)

Outdoor Unit

For Single



Remote Controller

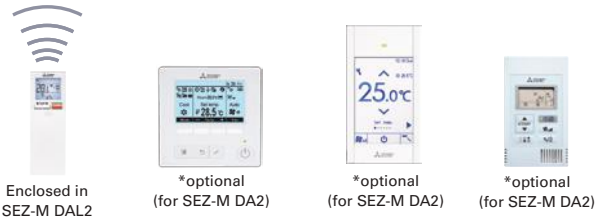

Indoor Unit Combination	Outdoor Unit Capacity				
	For Single				
	25	35	50	60	71
S Series	25x1	35x1	50x1	60x1	71x1
Distribution Pipe	-	-	-	-	-

Type			Inverter Heat Pump					
Indoor Unit			SEZ-M25DA(L)2	SEZ-M35DA(L)2	SEZ-M50DA(L)2	SEZ-M60DA(L)2	SEZ-M71DA(L)2	
Outdoor Unit			SUZ-M25VA	SUZ-M35VA	SUZ-M50VA	SUZ-M60VA	SUZ-M71VA	
Refrigerant ^(*)			R32					
Power Supply	Source	Outdoor power supply						
Cooling	Outdoor(V/Phase/Hz)	230/Single/50						
Cooling	Capacity	Rated	kW	2.5	3.5	5.0	6.1	7.1
		Min-Max	kW	1.4 - 3.2	0.7 - 3.9	1.1 - 5.6	1.6 - 6.3	2.2 - 8.1
	Total Input	Rated	kW	0.714	1.000	1.547	1.848	2.151
	EER ^(**)			3.50	3.50	3.23	3.30	3.30
	Design load		kW	2.5	3.5	5.0	6.1	7.1
	Annual electricity consumption ^(**)		kWh/a	146	202	290	385	451
SEER ^(**)			6.0	6.0	6.0	5.5	5.5	
Heating	Energy efficiency class			A+	A+	A+	A	A
	Capacity	Rated	kW	2.9	4.2	6.0	7.4	8.0
		Min-Max	kW	1.3 - 4.2	1.1 - 5.0	1.5 - 7.2	1.6 - 8.0	2.0 - 10.2
	Total Input	Rated	kW	0.803	1.076	1.617	2.049	2.285
	COP ^(**)			3.61	3.90	3.71	3.61	3.50
	Design load		kW	2.2	2.6	4.3	4.6	5.8
Declared Capacity	at reference design temperature	kW	2.0 (-10°C)	2.3 (-10°C)	3.8 (-10°C)	4.1 (-10°C)	5.2 (-10°C)	
	at bivalent temperature	kW	2.0 (-7°C)	2.3 (-7°C)	3.8 (-7°C)	4.1 (-7°C)	5.2 (-7°C)	
	at operation limit temperature	kW	2.0 (-10°C)	2.3 (-10°C)	3.8 (-10°C)	4.1 (-10°C)	5.2 (-10°C)	
Back up heating capacity		kW	0.2	0.3	0.5	0.5	0.6	
Annual electricity consumption ^(**)		kWh/a	769	878	1501	1516	2030	
SCOP ^(**)			4.0	4.1	4.0	4.2	3.9	
Energy efficiency class			A+	A+	A+	A+	A	
Operating Current(Max)		A	7.4	9.2	14.3	15.7	15.8	
Indoor Unit	Input [cooling / Heating]	Rated	kW	0.043	0.047	0.077	0.084	0.102
	Operating Current(Max)		A	0.62	0.65	0.82	0.88	1.00
	Dimensions	H*W*D	mm	200 - 790 - 700	200 - 990 - 700	200 - 990 - 700	200 - 1190 - 700	200 - 1190 - 700
	Weight		kg	18	22	22	25.5	25.5
	Air Volume (Lo-Mid-Hi)		m ³ /min	5.5 - 7 - 9	7 - 9 - 11	10 - 12.5 - 15	12 - 15 - 18	12 - 16 - 20
	External Static Pressure ^(*)		Pa	<5> - 25 - <35> - <50>	<5> - 25 - <35> - <50>	<5> - 25 - <35> - <50>	<5> - 25 - <35> - <50>	<5> - 25 - <35> - <50>
	Sound Level (Lo-Mid-Hi) (SPL)	Rated	dB(A)	23 - 26 - 30	23 - 27 - 31	30 - 34 - 37	30 - 34 - 38	30 - 35 - 40
		5Pa ^(**)	dB(A)	22 - 25 - 29	22 - 26 - 30	29 - 33 - 36	29 - 33 - 37	29 - 34 - 39
	Sound Level (PWL)		dB(A)	50	51	57	58	60
	Dimensions	H*W*D	mm	550-800-285	550-800-285	714-800-285	880-840-330	880-840-330
Outdoor Unit	Weight		kg	30	35	41	54	55
	Air Volume	Cooling	m ³ /min	36.3	34.3	45.8	50.1	50.1
		Heating	m ³ /min	34.6	32.7	43.7	50.1	50.1
	Sound Level (SPL)	Cooling	dB(A)	45	48	48	49	49
		Heating	dB(A)	46	48	49	51	51
	Sound Level (PWL)	Cooling	dB(A)	59	59	64	65	66
Operating Current(Max)		A	6.8	8.5	13.5	14.8	14.8	
Breaker Size		A	10	10	20	20	20	
Ext.Piping	Diameter ^(*)	Liquid/Gas	mm	6.35 / 9.52	6.35 / 9.52	6.35 / 12.7	6.35 / 15.88	9.52 / 15.88
	Max.Length	Out-In	m	20	20	30	30	30
	Max.Height	Out-In	m	12	12	30	30	30
Guaranteed Operating Range (Outdoor)	Cooling ^(*)	°C	-10 ~ +46	-10 ~ +46	-15 ~ +46	-15 ~ +46	-15 ~ +46	
	Heating	°C	-10 ~ +24	-10 ~ +24	-10 ~ +24	-10 ~ +24	-10 ~ +24	

*1 Refrigerant leakage contributes to climate change. Refrigerant with lower global warming potential (GWP) would contribute less to global warming than a refrigerant with higher GWP if leaked to the atmosphere. This appliance contains a refrigerant fluid with a GWP equal to 1975. This means that if 1 kg of this refrigerant fluid would be leaked to the atmosphere, the impact on global warming would be 1975 times higher than 1 kg of CO₂, over a period of 100 years. Never try to interfere with the refrigerant circuit yourself or disassemble the product yourself and always ask a professional. The GWP of R410A is 2088 in the IPCC 4th Assessment Report.
 *2 Energy consumption based on standard test results. Actual energy consumption will depend on how the appliance is used and where it is located.
 *3 SEER/SCOP are measured at ESP 25Pa.
 *4 SEER and SCOP are based on 2009/125/EC:Energy-related Products Directive and Regulation(EU) No206/2012.
 *5 Joint pipe is required depending on installed refrigerant pipes, outdoor units and indoor units.
 *6 The factory setting of ESP is shown without < > .
 *7 SPL measured at ESP 5Pa.

SEZ-M SERIES



Indoor Unit

R32
R410A



SEZ-M25/35/50/60/71DA2 (Requires Wired Remote Controller)
SEZ-M25/35/50/60/71DAL2 (Wireless Remote Controller is enclosed)

Outdoor Unit

R410A For Single



SUZ-KA25/35VA6



SUZ-KA50/60/71VA6

Remote Controller



Enclosed in SEZ-M DAL2



*optional (for SEZ-M DA2)



*optional (for SEZ-M DA2)



*optional (for SEZ-M DA2)



Indoor Unit Combination	Outdoor Unit Capacity				
	For Single				
S series	25	35	50	60	71
Distribution Pipe	25x1	35x1	50x1	60x1	71x1

Type			Inverter Heat Pump					
Indoor Unit			SEZ-M25DA(L)2	SEZ-M35DA(L)2	SEZ-M50DA(L)2	SEZ-M60DA(L)2	SEZ-M71DA(L)2	
Outdoor Unit			SUZ-KA25VA6	SUZ-KA35VA6	SUZ-KA50VA6	SUZ-KA60VA6	SUZ-KA71VA6	
Refrigerant ⁽¹⁾			R410A					
Power Supply	Source	Outdoor power supply						
Cooling	Capacity	Rated	2.5	3.5	5.1	5.6	7.1	
Heating	Capacity	Rated	2.9	4.2	6.4	7.4	8.1	
		Min-Max	1.3 - 4.5	1.7 - 5.0	1.7 - 7.2	2.5 - 8.0	2.6 - 10.4	
Total Input	Rated	0.731	1.012	1.580	1.740	2.210		
	Rated	3.42	3.46	3.23	3.22	3.21		
EER ⁽⁴⁾	Rated	3.42	3.46	3.23	3.22	3.21		
	Rated	3.42	3.46	3.23	3.22	3.21		
Design load	Annual electricity consumption ⁽²⁾	kWh/a	159	203	297	353	449	
	SEER ⁽⁴⁾⁽⁵⁾		5.5	6.0	6.0	5.5	5.5	
Energy efficiency class	Rated	A	A+	A+	A	A		
	Min-Max	A	A+	A+	A	A		
Total Input	Rated	0.803	1.132	1.800	2.200	2.268		
	Rated	3.61	3.71	3.56	3.36	3.50		
COP ⁽⁴⁾	Rated	3.61	3.71	3.56	3.36	3.50		
	Rated	3.61	3.71	3.56	3.36	3.50		
Design load	Annual electricity consumption ⁽²⁾	kWh/a	789	977	1614	1857	2147	
	SCOP ⁽⁴⁾⁽⁵⁾		3.9	4.0	3.9	4.1	3.9	
Energy efficiency class	Rated	A	A+	A	A+	A		
	Min-Max	A	A+	A	A+	A		
Operating Current(Max)	Rated	A	7.6	8.9	12.8	14.9	17.1	
	Rated	A	7.6	8.9	12.8	14.9	17.1	
Indoor Unit	Input (cooling / Heating)	Rated	kW	0.043	0.047	0.077	0.084	0.102
	Operating Current(Max)	Rated	A	0.62	0.65	0.82	0.88	1.00
Dimensions	H*W*D	mm	200 - 790 - 700	200 - 990 - 700	200 - 990 - 700	200 - 1190 - 700	200 - 1190 - 700	
	Weight	kg	18	22	22	25.5	25.5	
Air Volume (Lo-Mid-Hi)	Cooling	m ³ /min	5.5 - 7 - 9	7 - 9 - 11	10 - 12.5 - 15	12 - 15 - 18	12 - 16 - 20	
	Heating	m ³ /min	32.6	36.3	44.6	40.9	50.1	
External Static Pressure ⁽⁶⁾	Rated	Pa	<5> - 25 - <35> - <50>	<5> - 25 - <35> - <50>	<5> - 25 - <35> - <50>	<5> - 25 - <35> - <50>	<5> - 25 - <35> - <50>	
	5Pa ⁽⁷⁾	dB(A)	23 - 26 - 30	23 - 27 - 31	30 - 34 - 37	30 - 34 - 38	30 - 35 - 40	
Sound Level (Lo-Mid-Hi) (SPL)	Rated	dB(A)	22 - 25 - 29	22 - 26 - 30	29 - 33 - 36	29 - 33 - 37	29 - 34 - 39	
	5Pa ⁽⁷⁾	dB(A)	50	51	57	58	60	
Sound Level (PWL)	Rated	dB(A)	50	51	57	58	60	
	5Pa ⁽⁷⁾	dB(A)	50	51	57	58	60	
Outdoor Unit	Dimensions	H*W*D	mm	550-800-285	550-800-285	880-840-330	880-840-330	880-840-330
	Weight	kg	30	35	54	50	53	
Air Volume	Cooling	m ³ /min	32.6	36.3	44.6	40.9	50.1	
	Heating	m ³ /min	34.7	34.8	44.6	49.2	48.2	
Sound Level (SPL)	Cooling	dB(A)	47	49	52	55	55	
	Heating	dB(A)	48	50	52	55	55	
Sound Level (PWL)	Cooling	dB(A)	58	62	65	65	69	
	Heating	dB(A)	58	62	65	65	69	
Operating Current(Max)	Rated	A	7	8.0	12	14	16.1	
	Rated	A	7	8.0	12	14	16.1	
Breaker Size	Rated	A	10	10	20	20	20	
	Rated	A	10	10	20	20	20	
Ext.Piping	Diameter ⁽⁸⁾	Liquid/Gas	mm	6.35 / 9.52	6.35 / 9.52	6.35 / 12.7	6.35 / 15.88	9.52 / 15.88
	Max.Length	Out-In	m	20	20	30	30	30
	Max.Height	Out-In	m	12	12	30	30	30
Guaranteed Operating Range (Outdoor)	Cooling ⁽⁹⁾	°C	-10 ~ +46	-10 ~ +46	-15 ~ +46	-15 ~ +46	-15 ~ +46	
	Heating	°C	-10 ~ +24	-10 ~ +24	-10 ~ +24	-10 ~ +24	-10 ~ +24	

*1 Refrigerant leakage contributes to climate change. Refrigerant with lower global warming potential (GWP) would contribute less to global warming than a refrigerant with higher GWP, if leaked to the atmosphere. This appliance contains a refrigerant fluid with a GWP equal to 1975. This means that if 1 kg of this refrigerant fluid would be leaked to the atmosphere, the impact on global warming would be 1975 times higher than 1 kg of CO₂ over a period of 100 years. Never try to interfere with the refrigerant circuit yourself or disassemble the product yourself and always ask a professional.

The GWP of R410A is 2088 in the IPCC 4th Assessment Report.

*2 Energy consumption based on standard test results. Actual energy consumption will depend on how the appliance is used and where it is located.

*3 SEER/SCOP are measured at ESP 25Pa.

*4 SEER and SCOP are based on 2009/125/EC:Energy-related Products Directive and Regulation(EU) No206/2012.

*5 Joint pipe is required depending on installed refrigerant pipes, outdoor units and indoor units.

*6 The factory setting of ESP is shown without < >.

*7 SPL measured at ESP 5Pa.

SFZ SERIES

The concealed floor standing type indoor unit is newly introduced to the S-series and can be neatly installed in the perimeter zone. High energy efficiency is achieved across all capacity range. External static pressure, airflow rate, and air intake direction can be selected according to the customer's choice.

R32



SFZ-M25/35/50/60/71VA



A wide lineup offering high energy efficiency

The SFZ series achieves an A++ rating on the SEER index, and an A+ rating on the SCOP index for all capacity range. No matter which capacity you select, the series offers a high level of energy efficiency.

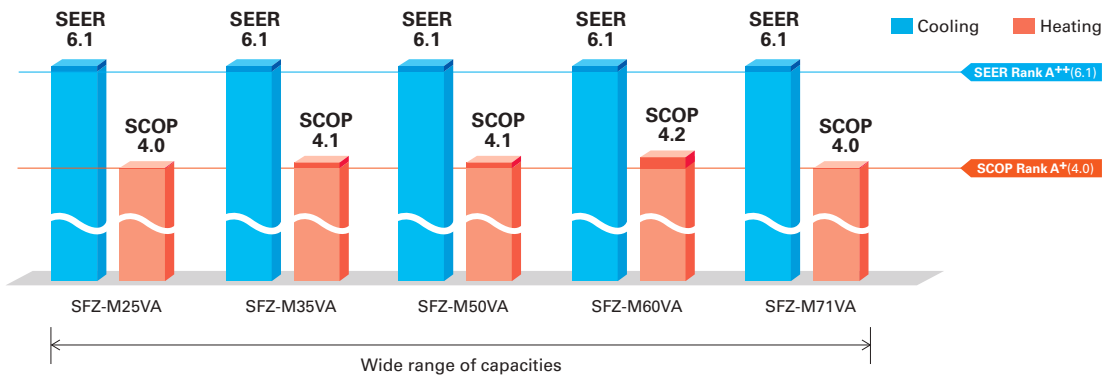

Compact body and small footprint

With the control box built inside the unit, the compact body and small footprint are realized. This allows the unit to be installed within a small perimeter zone.

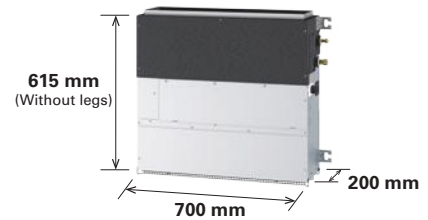

Flexible installation

Air inlet direction from the bottom or front can be selected by changing panel, fan guard and filter.

Bottom suction *1

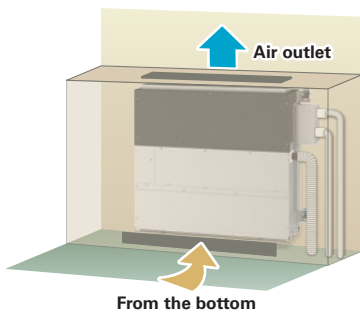

Front suction *2

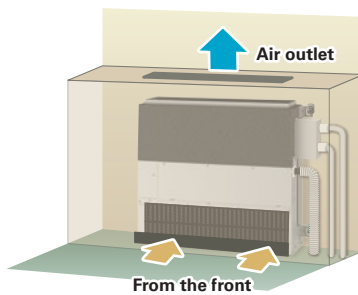

Installation with legs

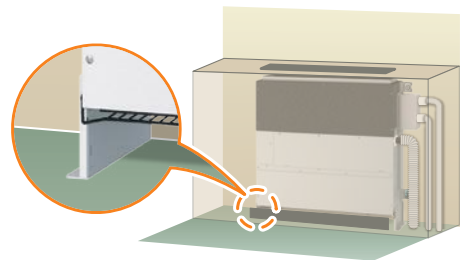

*Height of unit (with legs) is 690 mm.
*Legs are supplied as accessory with the unit.

*1 Select a site where the flow of supply air is not blocked. The unit cannot be placed directly on the floor in the case of bottom suction.

*2 Unit with front suction generate more noise compared to bottom suction. Not recommended to be installed in rooms such as bedrooms where quietness is valued.

Fan speed

Airflow rate can be selected from 3 patterns; Low-Medium-High.

External static pressure

Four levels of static pressure are available. The ability to select additional static pressure provides flexibility for air outlet configuration.

SFZ-M25/35/50/60/71VA <0>/25/<40>/<60> Pa

The factory setting of external static pressure is shown without brackets (<>).

Refer to "Fan characteristics curves" according to the external static pressure, in the DATA BOOK for the usable range of airflow rate.

SFZ-M SERIES

Indoor Unit

R32



SFZ-M25/35/50/60/71VA

Outdoor Unit

R32

R32

R32



SUZ-M25/35VA



SUZ-M50VA



SUZ-M60/71VA

Remote Controller



PAR-40MAA
*Optional



PAR-CT01MAA
*Optional



PAC-YT52CRA
*Optional

Type			Inverter Heat Pump						
Indoor Unit			SFZ-M25VA	SFZ-M35VA	SFZ-M50VA	SFZ-M60VA	SFZ-M71VA		
Outdoor Unit			SUZ-M25VA	SUZ-M35VA	SUZ-M50VA	SUZ-M60VA	SUZ-M71VA		
Refrigerant*1			R32*1						
Power Supply	Source		Outdoor power supply						
	Outdoor (V/Phase/Hz)		230 / Single / 50						
Cooling	Capacity	Rated	kW	2.5	3.5	5.0	6.1	7.1	
		Min - Max	kW	1.5 - 3.2	0.7 - 3.9	1.1 - 5.6	1.6 - 6.3	1.9 - 8.1	
	Total Input	Rated	kW	0.641	1.000	1.470	1.848	2.151	
	EER			3.90	3.50	3.40	3.30	3.30	
	Design Load		kW	2.5	3.5	5.0	6.1	7.1	
	Annual Electricity Consumption*2		kWh/a	143	199	284	346	403	
	SEER*4*5			6.1	6.1	6.1	6.1	6.1	
	Energy Efficiency Class			A++	A++	A++	A++	A++	
	Heating (Average Season)	Capacity	Rated	kW	3.2	4.1	6.0	7.0	8.0
			Min - Max	kW	1.2 - 4.2	1.0 - 5.0	1.5 - 7.2	1.6 - 8.0	2.0 - 10.2
Total Input		Rated	kW	0.886	1.051	1.617	1.886	2.156	
COP				3.61	3.90	3.71	3.71	3.71	
Design Load			kW	2.2	2.6	4.3	4.6	5.8	
Declared Capacity		at reference design temperature	kW	2.0 (-10°C)	2.3 (-10°C)	3.3 (-10°C)	4.1 (-10°C)	5.2 (-10°C)	
		at bivalent temperature	kW	2.0 (-7°C)	2.3 (-7°C)	3.8 (-7°C)	4.1 (-7°C)	5.2 (-7°C)	
		at operation limit temperature	kW	2.0 (-10°C)	2.3 (-10°C)	3.3 (-10°C)	4.1 (-10°C)	5.2 (-10°C)	
Back Up Heating Capacity			kW	0.2	0.3	1.0	0.5	0.6	
Annual Electricity Consumption*2			kWh/a	766	887	1467	1532	1997	
SCOP*4*5			4.0	4.1	4.1	4.2	4.0		
Energy Efficiency Class			A+	A+	A+	A+	A+		
Operating Current (max)			A	7.2	8.9	14.1	15.4	15.6	
Indoor Unit	Input	Rated	kW	0.041	0.044	0.072	0.078	0.095	
		Operating Current (max)	A	0.44	0.44	0.61	0.64	0.76	
	Dimensions <Panel>*6*7	H x W x D	mm	615 (690) - 797 (700) - 200	615 (690) - 997 (900) - 200	615 (690) - 997 (900) - 200	615 (690) - 1197 (1100) - 200	615 (690) - 1197 (1100) - 200	
	Weight <Panel>		kg	18.5	22.5	22.5	25.5	25.5	
	Air Volume [Lo-Mid-Hi]		m ³ /min	5.5 - 7 - 9	7 - 9 - 11	10 - 12.5 - 15	12 - 15 - 18	12 - 16 - 20	
	External Static Pressure*8		Pa	<0> / 25 / <40> / <60>	<0> / 25 / <40> / <60>	<0> / 25 / <40> / <60>	<0> / 25 / <40> / <60>	<0> / 25 / <40> / <60>	
	Sound Level (SPL)*9 [Lo-Mid-Hi]		dB(A)	25 - 29 - 35	25 - 29 - 33	30 - 35 - 39	30 - 35 - 39	30 - 36 - 42	
	Sound Level (PWL)		dB(A)	54	53	59	59	61	
	Outdoor Unit	Dimensions	H x W x D	mm	550 - 800 - 285	550 - 800 - 285	714 - 800 - 285	880 - 840 - 330	880 - 840 - 330
			Weight	kg	30	35	41	54	55
Air Volume		Cooling	m ³ /min	36.3	34.3	45.8	50.1	50.1	
		Heating	m ³ /min	34.6	32.7	43.7	50.1	50.1	
Sound Level (SPL)		Cooling	dB(A)	45	48	48	49	49	
		Heating	dB(A)	46	48	49	51	51	
Sound Level (PWL)		Cooling	dB(A)	59	59	64	65	66	
Operating Current (max)			A	6.8	8.5	13.5	14.8	14.8	
Breaker Size			A	10	10	20	20	20	
Ext. Piping		Diameter	Liquid / Gas	mm	6.35 / 9.52	6.35 / 9.52	6.35 / 12.7	6.35 / 15.88	9.52 / 15.88
	Max. Length	Out-In	m	20	20	30	30	30	
	Max. Height	Out-In	m	12	12	30	30	30	
Guaranteed Operating Range [Outdoor]	Cooling*3	°C	-10 ~ +46	-10 ~ +46	-15 ~ +46	-15 ~ +46	-15 ~ +46		
	Heating	°C	-10 ~ +24	-10 ~ +24	-10 ~ +24	-10 ~ +24	-10 ~ +24		

*1 Refrigerant leakage contributes to climate change. Refrigerant with lower global warming potential (GWP) would contribute less to global warming than a refrigerant with higher GWP, if leaked to the atmosphere. This appliance contains a refrigerant fluid with a GWP equal to 1975. This means that if 1 kg of this refrigerant fluid would be leaked to the atmosphere, the impact on global warming would be 1975 times higher than 1 kg of CO₂ over a period of 100 years. Never try to interfere with the refrigerant circuit yourself or disassemble the product yourself and always ask a professional.

The GWP of R410A is 2088 in the IPCC 4th Assessment Report.

*2 Energy consumption based on standard test results. Actual energy consumption will depend on how the appliance is used and where it is located.

*3 SEER/SCOP are measured at ESP 25Pa.

*4 SEER and SCOP are based on 2009/125/EC:Energy-related Products Directive and Regulation(EU) No206/2012.

*5 Joint pipe is required depending on installed refrigerant pipes, outdoor units and indoor units.

*6 The height that includes the duct flange is 638 (713) mm. The values in () show the height of unit with leg.

*7 The width includes the pipe cover (sheet metal). The values in () show the width that does not include the pipe cover.

*8 The factory setting of ESP is shown without < >.

*9 SPL measured at ESP 25Pa.

CONTROL TECHNOLOGIES



PAR-41MAA

User-friendly Deluxe Remote Controller with Excellent Operability and Visibility

2+1 Back-up rotation*

The use of a three-refrigerant air conditioning system enables you to utilize the back-up, rotation, and cut-in functions. This allows you to implement effective risk management for added peace of mind.

*Availability of this function is depending on outdoor unit, indoor unit and remote controller.

Back-up Function

In the unlikely event that one of the units stops operation due to an abnormality, the standby unit immediately starts back-up operation. Being fully prepared for a failure guarantees that an operation is always available and gives you the confidence that your system will be reliable in any situation.



Rotation Function

A single remote controller is used to operate three-refrigerant air conditioning system in a rotation pattern. Reducing the burden on the equipment allows you to maintain a longer time between maintenance and increases product life.

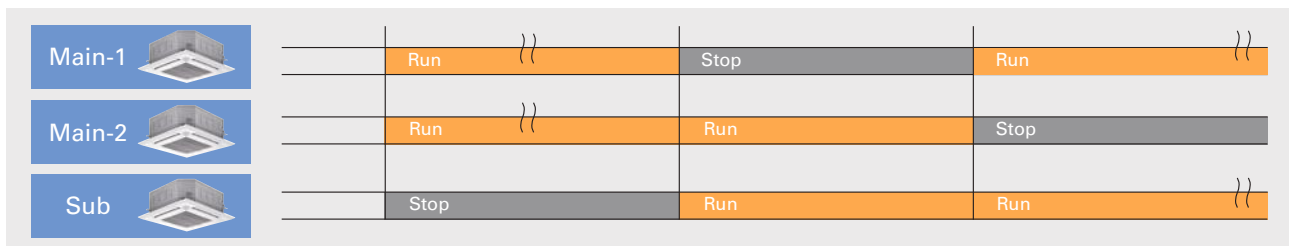

Cut-in Function

If the actual room temperature greatly differs from the set temperature and two-refrigerant air conditioning system is insufficient, the standby unit starts operation to provide support.

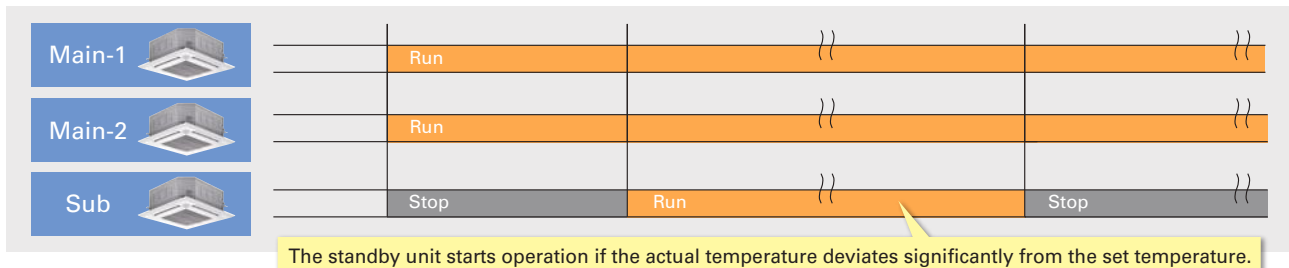















P

SERIES

















SELECTION

Line-up includes a selection of eight indoor units and four series of outdoor units. Easily construct a system that best matches room air conditioning needs.

R32 INDOOR UNIT		R32 OUTDOOR UNIT	
 4-way ceiling-cassette PLA-ZM EA PLA-M EA	 Wall-mounted PKA-M LA (L) PKA-M KA (L)	Power Inverter  PUZ-ZM35/50  PUZ-ZM60/71  PUZ-ZM100/125/140/ 200/250	Standard Inverter  SUZ-M35  SUZ-M50  SUZ-M60/71  PUZ-M100/125/140  PUZ-M200/250
 Ceiling-concealed PEAD-M	 Ceiling-concealed PEA-M		
 Ceiling-suspended PCA-M	 Floor-standing PSA-M		
 Professional Kitchen PCA-M HA			

* Some indoor units cannot be used with this unit.





R410A INDOOR UNIT		R410A OUTDOOR UNIT	
 4-way ceiling-cassette PLA-ZM EA PLA-M EA	 Wall-mounted PKA-M LA (L) PKA-M KA (L)	Power Inverter  PUHZ-ZRP35/50  PUHZ-ZRP60/71  PUHZ-ZRP100/125/140/ 200/250	Standard Inverter  SUZ-KA35  SUZ-KA50/60/71  PUHZ-P100/125/140  PUHZ-P200/250
 Ceiling-concealed PEAD-M	 Floor-standing PSA-M		
 Ceiling-suspended PCA-M	 Ceiling-concealed PEA-M		
 Professional Kitchen PCA-M HA			

To confirm compatibility with the MXZ Series, refer to the MXZ Series page.

* Some indoor units cannot be used with this unit.

SELECT COMBINATION

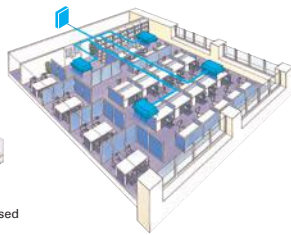
Choose the installation pattern for the indoor units. (In the case of a multi-system, distribution piping is necessary, so please select the necessary piping as well.)

Single System 	Simultaneous Multi-System Twin Allows simultaneous operation of two indoor units on one floor. 	Quadruple Realises the optimum temperature distribution even in a large space. 
	Triple Can cover a large-scale space or dispersed installation on the same floor. 	

Connectable Combinations for Inverter Units

Outdoor Unit Capacity	Indoor Unit Capacity		
	Twin 50 : 50	Triple 33 : 33 : 33	Quadruple 25 : 25 : 25 : 25
71	35 × 2	—	—
100	50 × 2	—	—
125	60 × 2	—	—
140	71 × 2	50 × 3	—
200	100 × 2	60 × 3	50 × 4
250	125 × 2	71 × 3	60 × 4
Distribution Pipe	MSDD-50TR-E MSDD-50WR-E MSDD-50TR2-E2 MSDD-50WR2-E	MSDT-111R-E MSDT-111R3-E	MSDF-1111R-E MSDF-1111R2-E

Note: The distribution pipe listed is required for simultaneous multi-systems.

Power Inverter SERIES

Our Eco-conscious Power Inverter Series is designed to achieve industry-leading seasonal energy-efficiency through use of New R32 refrigerant and advanced technologies.



Industry-leading energy efficiency

Introduction of new R32 refrigerant realises improved cooling efficiency. Rating of more than 7.0 achieved for all capacity range.

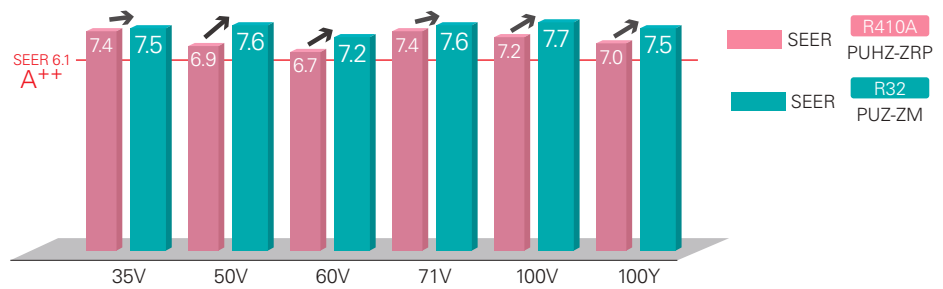

Introduction of new R32 refrigerant reduces energy consumption and realises energy savings.

Longer piping (60/71/100/125/140/200/250)

Longer piping length realised for 60, 71, 100, 125, 140, 200 and 250 classes, widely increasing installation flexibility.

	Piping Length	
	R410A PUHZ-ZRP	R32 PUZ-ZM
35/50	50m	50m
60/71	50m	55m
100/125/140	75m	100m
200/250	100m	100m

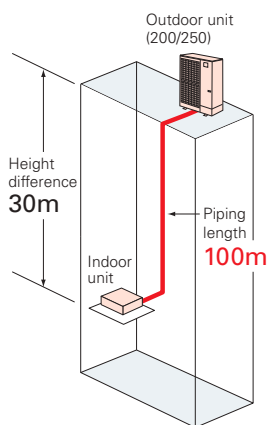

Rated heating capacity maintained down to -3°C*

Rated heating capacity maintained even when the outside temperature is down to -3°C. Stay warm even at times of cold weather.

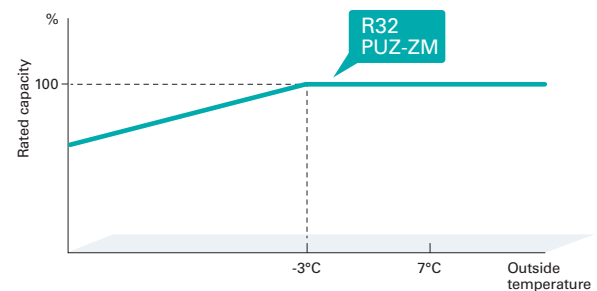

2+1 Back-up rotation*

The use of a three-refrigerant air conditioning system enables you to utilize the back-up, rotation, and cut-in functions. This allows you to implement effective risk management for added peace of mind.

*Availability of this function is depending on outdoor unit, indoor unit and remote controller.

Back-up Function

In the unlikely event that one of the units stops operation due to an abnormality, the standby unit immediately starts back-up operation. Being fully prepared for a failure guarantees that and operation is always available and gives you the confidence that your system will be reliable in any situation.

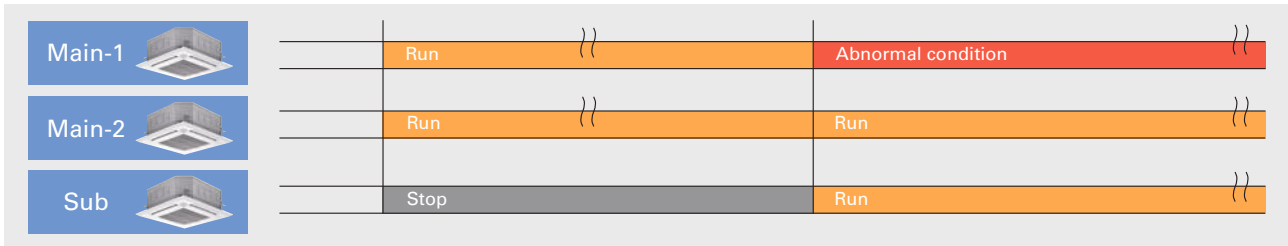

Rotation Function

A single remote controller is used to operate three-refrigerant air conditioning system in a rotation pattern. Reducing the burden on the equipment allows you to maintain a longer time between maintenance and increases product life.

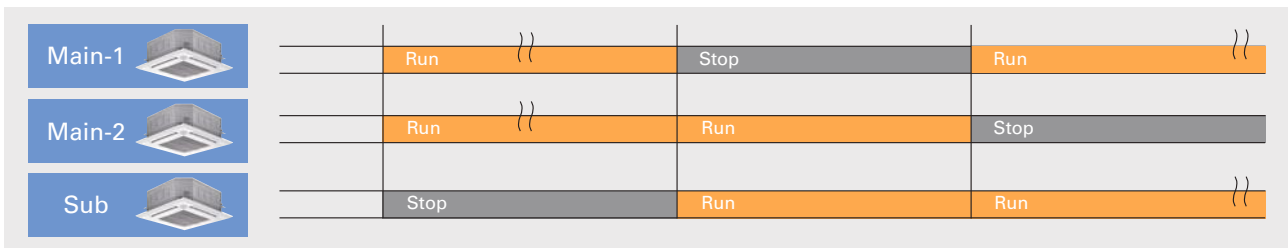

Cut-in Function

If the actual room temperature greatly differs from the set temperature and two-refrigerant air conditioning system is insufficient, the standby unit starts operation to provide support.

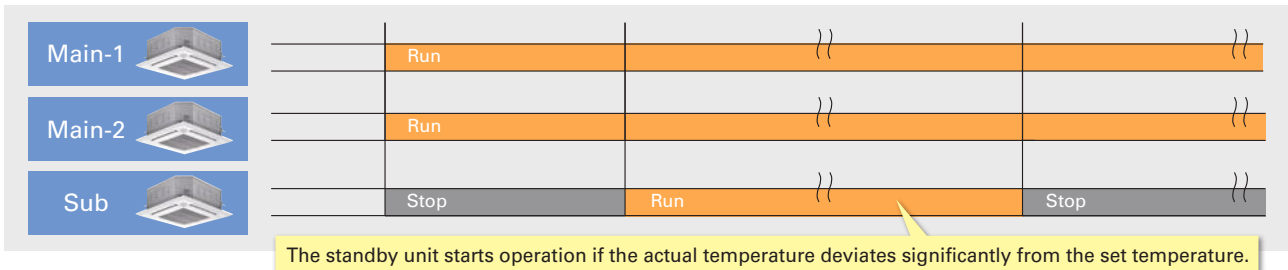

Extended cooling set temperature range*

In environments such as gyms where people do strenuous exercise, even if the room is cooled to an appropriate temperature, people may feel that it is hot, and they need a cooler air. To satisfy such demands, we have extended the lower limit of the cooling set temperature range from 19–30°C. to 14–30°C.

*Insulation kit (PAC-SK36HK-E) is required when indoor unit is PLA series.

*Availability of this function is depending on outdoor unit, indoor unit and remote controller.

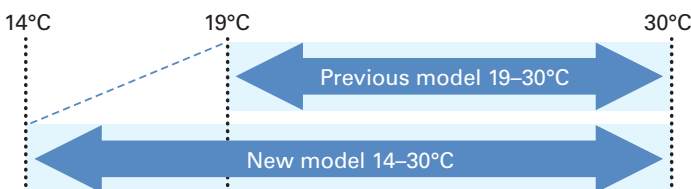

Display of model names and serial numbers*

The model names and serial numbers of the indoor/outdoor units that are connected to the MA smart remote controller can be automatically acquired and displayed through one simple operation. This eliminates the need to directly check each unit and helps with inquiries in the case of an abnormality.

*Availability of this function is depending on outdoor unit, indoor unit and remote controller.

● Model name display (example)

```
Collect model names and S/N
OU PUZ-ZM200YKA2
IU1 PLA-ZM50EA2
IU2 PLA-ZM50EA2
IU3 PLA-ZM50EA2
IU4 PLA-ZM50EA2
Collect data: ✓
-Address + S/N
```

● Serial number display (example)

```
Collect model names and S/N
OU 1ZU0001
IU1 1ZA0001
IU2 1ZA0002
IU3 1ZA0003
IU4 1ZA0004
Collect data: ✓
-Address + Model
```

Preliminary error history*

In addition to error history, the history of preliminary abnormalities can be displayed. The feature enables the unit status check during inspection and maintenance.

*Availability of this function is depending on outdoor unit, indoor unit and remote controller.

●Error history (Sample)

Error history		1/4
Error	Unt# dd/mm/yy	
E0	0-1 21/10/20 PM12:34	
E0	0-1 20/12/20 AM 1:23	
E0	0-1 20/11/20 PM10:55	
E0	0-1 20/10/20 PM12:01	
Error history menu: ↻		
▼ Page ▲		Delete

●Preliminary error history (Sample)

Preliminary error hist.		1/8
Error	Unt# dd/mm/yy	
E0	0-1 21/10/20 PM12:34	
E0	0-1 20/12/20 AM 1:23	
E0	0-1 20/11/20 PM10:55	
E0	0-1 20/10/20 PM12:01	
Error history menu: ↻		
▼ Page ▲		Delete

Display of power consumption*

It is possible to measure, acquire, and display the amount of energy used by each air conditioning system.

*Availability of this function is depending on outdoor unit, indoor unit and remote controller.

< Data Collection Period >

Time data: Every 30 minutes over the past month

Monthly/daily data: Monthly over the past 14 months

Energy consumption values are calculated from estimated power consumption values according to the operating conditions. They may vary from the actual power consumption values. Please note that the power consumption of optional parts is not included except in the case of optional parts that have their power supplied directly by the outdoor unit.

●Every 30 minutes (example)

Energy data	
2019- 1- 1	1234.5kWh 1/6
0:30 123.4kWh	2:30 123.4kWh
1:00 123.4kWh	3:00 123.4kWh
1:30 123.4kWh	3:30 123.4kWh
2:00 123.4kWh	4:00 123.4kWh
Return: ↻	
- Date +	▼ Page ▲

●Daily (example)

Energy data	
2019- 1	123456.7kWh 1/4
31 1234.5kWh	27 1234.5kWh
30 1234.5kWh	26 1234.5kWh
29 1234.5kWh	25 1234.5kWh
28 1234.5kWh	24 1234.5kWh
Return: ↻	
▼ Page ▲	

●Monthly (example)

Energy data	
▶2019- 1	123456.7kWh 1/3
2018-12	123456.7kWh
2018-11	123456.7kWh
2018-10	123456.7kWh
2018- 9	123456.7kWh
View daily data: ✓	
▼ Cursor ▲	

Improved defrosting performance*

*Availability of this function is depending on outdoor unit, indoor unit and remote controller.

Avoiding Simultaneous Defrosting

When each of multiple units is in operation for heating in the same space, these may start defrosting at the same time, resulting in a drop in the room temperature. Therefore, we have developed a new function that controls up to four-refrigerant air conditioning system to avoid simultaneous defrosting. By ensuring that defrosting is only performed by one unit at a time, it is possible to minimize any decrease in room temperature.

Example System Configuration

Four sets controlled by a single remote controller

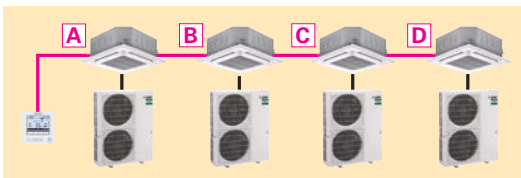

■When All Sets Are Controlled Together

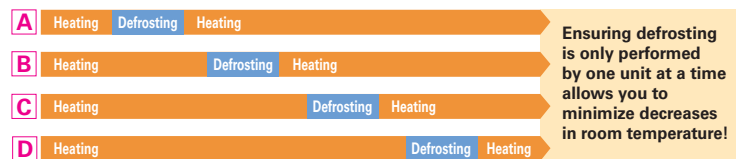

Defrosting When People Are Absent

The use of the 3D i-see sensor allows a more comfortable defrosting schedule. After a large amount of frost has built up, the system will switch to defrosting when the 3D i-see sensor detects that no people are present. By minimizing defrosting while people are in the room, there is a much lower chance of a temperature drop while the room is occupied.

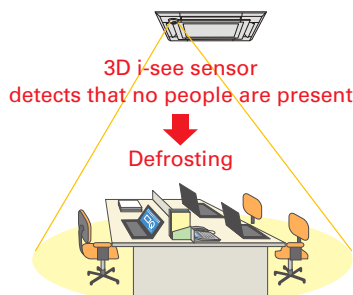

* Only compatible with 4-way cassette and 2x2 cassette models with an attached 3D i-see sensor panel. Even though people are present in the room, the defrosting process may start if all defrosting conditions are met.

Defrosting When Operation is Stopped

It takes a long time to start operation if there is an excess build-up of frost. Therefore, each unit is equipped with a control system where defrosting is performed immediately after operation is stopped when there is a large amount of frost. This allows heating to be quickly started the next day.

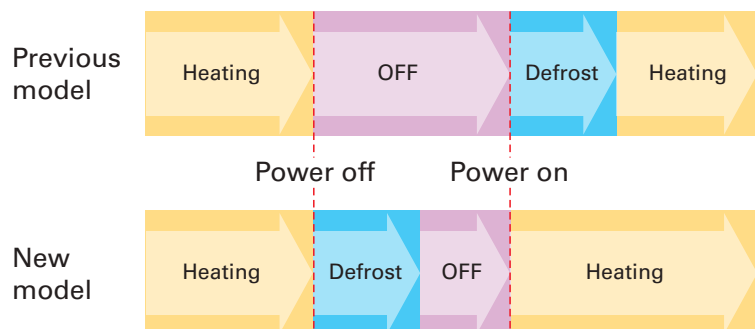

The power turns off after defrosting is complete and the system will start up smoothly the next time it is used.

Easier M-NET Adapter Installation

The optional M-NET adapter, which allows centralized control (M-NET control), is now easier to install. The redesigned mounting position significantly reduces the time and effort for installation.

Conventional Model

PAC-SJ96MA-E

Removed parts

The (1) top panel, (2) front panel, (3) service panel, and (4) electronics box need to be removed, and the connector must be temporarily unplugged.

M-NET adapter mounting position

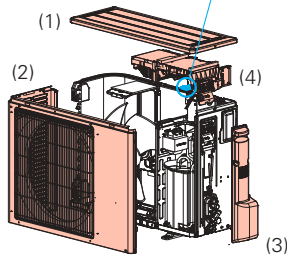

New Model

PAC-SK15MA-E

Removed parts

There is no need to remove the (1) top panel, (2) service panel, (3) service plate, electronics box, nor temporarily unplug the connector.

M-NET adapter mounting position

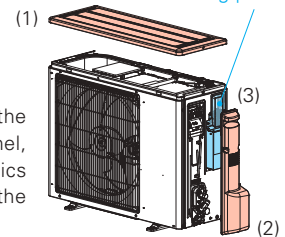

Improved chargeless piping length ZM100/125/140

PUZ-ZM100/125/140V(Y)KA used to have a chargeless pipe length of 30 m. However, starting with the V(Y)KA2 model, this has been extended to 40 m. This allows it to be used for a wider range of applications without the need for additional charging of refrigerant.

	Maximum piping length	Chargeless piping length			Maximum piping length	Chargeless piping length
PUZ-ZM 100V (Y)KA	100m	30m	→	PUZ-ZM 100V (Y)KA2	100m	40m
PUZ-ZM 125V (Y)KA	100m	30m	→	PUZ-ZM 125V (Y)KA2	100m	40m
PUZ-ZM 140V (Y)KA	100m	30m	→	PUZ-ZM 140V (Y)KA2	100m	40m

Utilizing IoT for Improved Convenience*

*Availability of IoT functions are depending on MELCloud version.

By connecting to a MAC-587IF-E Wi-Fi interface, it is possible to collect data and perform air conditioning control via MELCloud. In addition to basic functions such as turning the power on/off and setting the temperature, it is also possible to acquire data used for maintenance and inspection such as model names, serial numbers, and operation data.

[Basic Operation Functions]

- Operation on/off
- Temperature setting
- Operation mode
- Airflow speed
- Airflow direction etc...

[Data Collection and Display]

- Model name display
- Serial number display
- Collection of operation data
- Energy consumption display etc...

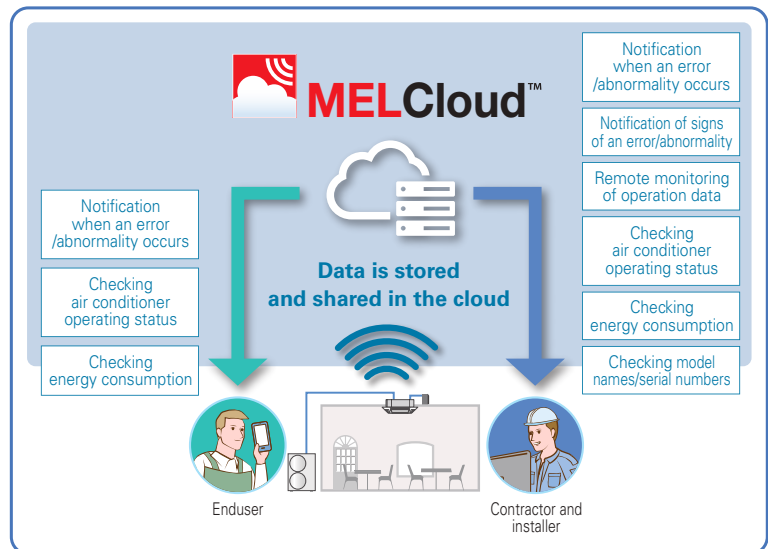

MELCloud System Configuration

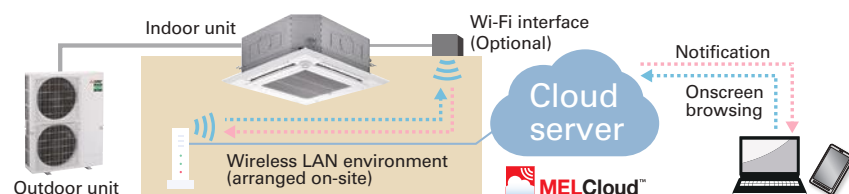

Wi-Fi Adapter (Optional) Installation

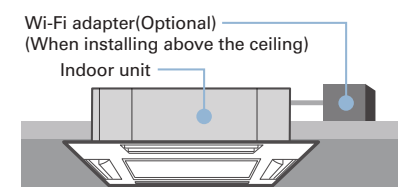

On-Site Installation and Configuration

① Wireless LAN adapter installation

Connect the wireless LAN adapter to the indoor unit PCB and install it above the ceiling.

② Wireless LAN adapter and router connection settings

③ Wireless LAN adapter and server connection settings

Collection of operation data

All the operation data required for maintenance and inspection can be collected in a simple step. This data can then be easily checked via MELcloud. This makes it easy to check the operating status data even in cases when it is difficult to do a visual inspection. This allows you to quickly identify any system malfunctions. This function also helps to improve the quality of installation work and shortening the time required for maintenance and inspection.

Operation data that can be collected (example)

- Compressor frequency ●Compressor operating current ●Outdoor discharge temperature
- Outdoor heat exchanger temperature ●Outdoor air temperature ●Compressor shell temperature
- Sub cool ●Discharge superheat ●Indoor inlet temperature ●Indoor heat exchanger temperature
- Total compressor operating time●Compressor operation count ●Indoor filter operating time

This operation data is strange...



*1 The total compressor operating time is displayed in units of 10 hours. The compressor operation count is displayed in units of 100.
*2 Indicates the elapsed time since a filter sign reset was performed.

Demand control

It is possible to control air-conditioners to appropriately operate according to the energy supply-demand adjustment by electric power companies and each electricity rate plan of end users.

e.g. <Peak cut control> It is possible to utilize an external demand signal to reduce power consumption during peak hours. By satisfying the need for reducing peak power consumption or shifting consumption to a non-peak period, we have increased the range of options for our customers.

Notification of potential abnormality

The comprehensive analysis of operating data allows the early detection of abnormalities in small functional parts by alerting the operator of any signs of abnormal behaviour. The recognition in advance of abnormalities in each unit further improves the ease of servicing and maintenance. Since this allows a countermeasure to be implemented before the abnormality requires the unit to be completely shut down, it is an effective method for maintaining the unit in its optimum condition.

[Abnormalities That Have Their Signs Monitored]

- Filter blockage ●Drain blockage ●Refrigerant leakage
- Heat exchanger blockage etc...

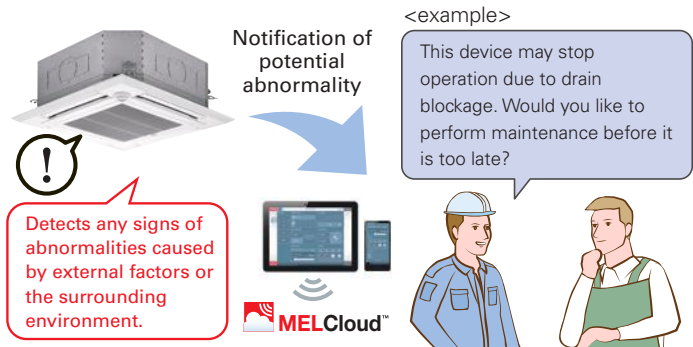

Standard Inverter SERIES

Our Standard Series become light and compact with greater energy-saving performance.

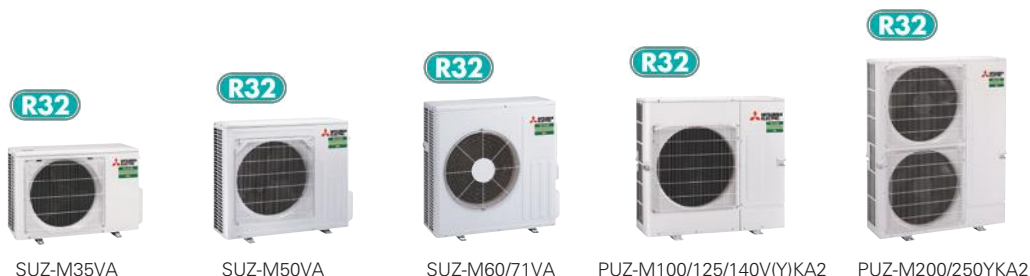

SUZ-M35VA

SUZ-M50VA

SUZ-M60/71VA

PUZ-M100/125/140V(Y)KA2

PUZ-M200/250YKA2

Improved energy efficiency

Introduction of new R32 refrigerant realizes improved cooling efficiency. Rating of more than 6.6 achieved for all capacity range.

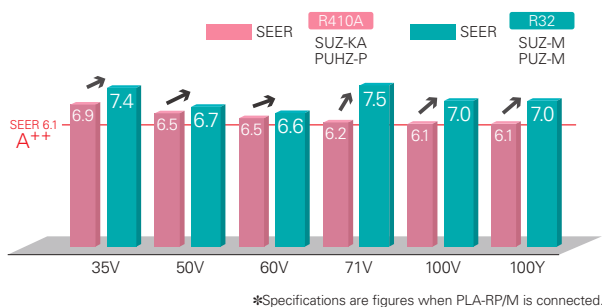

Longer piping (100/125/140/200/250)

Longer piping length realised for 100, 125, 140, 200 and 250 classes, widely increasing installation flexibility.

	Max. Piping Length	
	R410A SUZ-KA PUHZ-P	R32 SUZ-M PUZ-M
25/35	20m	20m
50/60/71	30m	30m
100	50m	55m
125/140	50m	65m
200/250	70m	70m

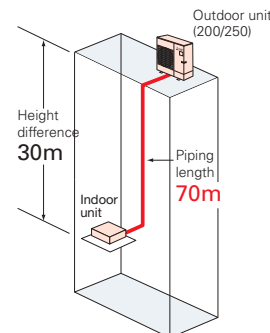

Light weight and compact size

Compact design fits into narrow outdoor unit space of condominiums and offices. Light weight design facilitates easy installation.



SUZ-KA50VA6

Height 880mm
Weight 54kg



SUZ-M50VA

Height 714mm **18% reduction**
Weight 41kg **24% reduction**



PUHZ-P140YHA2

Height 1,350mm
Weight 101kg



PUZ-M140YKA2

Height 981mm **27% reduction**
Weight 85kg **15% reduction**

Unobstructive, compact, and easy to hide from view

Conventional outdoor units may spoil the view. Due to its compact size, the new model can be installed in locations that previous model is not suitable.

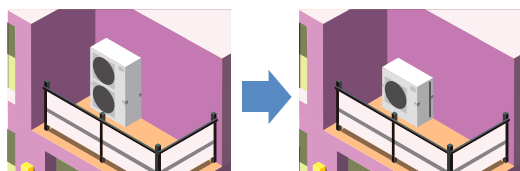

Easy transportation and installation

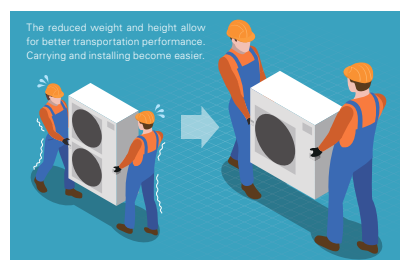

Transport efficiency improves thanks to its low height. The unit can even be transported by minivan.

2+1 Back-up rotation*

The use of a three-refrigerant air conditioning system enables you to utilize the back-up, rotation, and cut-in functions. This allows you to implement effective risk management for added peace of mind.

*Availability of this function is depending on outdoor unit, indoor unit and remote controller.

Back-up Function

In the unlikely event that one of the units stops operation due to an abnormality, the standby unit immediately starts back-up operation. Being fully prepared for a failure guarantees that and operation is always available and gives you the confidence that your system will be reliable in any situation.

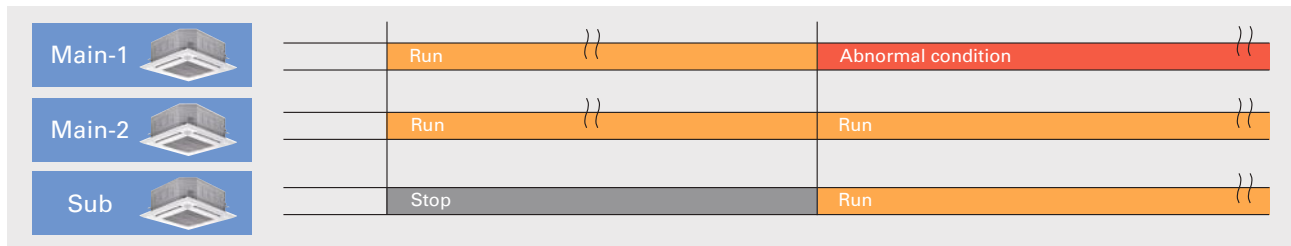

Rotation Function

A single remote controller is used to operate three-refrigerant air conditioning system in a rotation pattern. Reducing the burden on the equipment allows you to maintain a longer time between maintenance and increases product life.

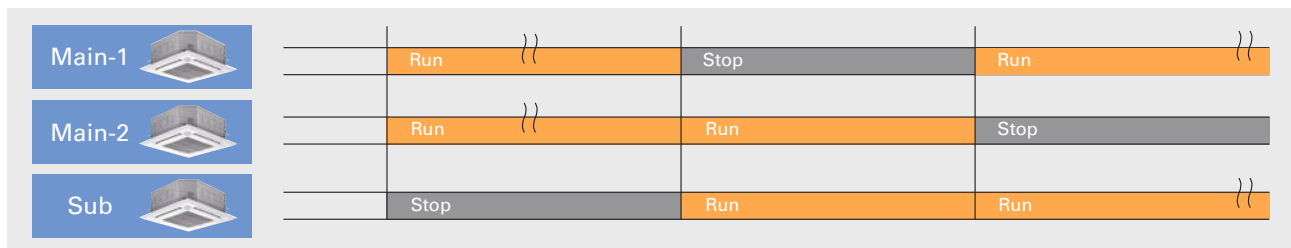

Cut-in Function

If the actual room temperature greatly differs from the set temperature and two-refrigerant air conditioning system is insufficient, the standby unit starts operation to provide support.

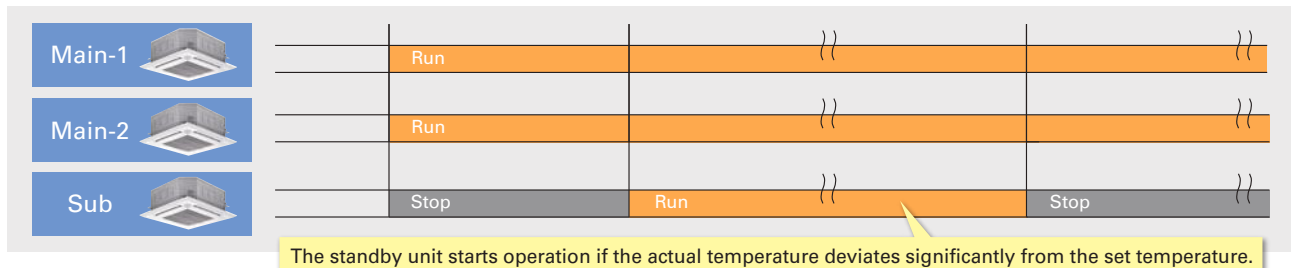

Extended cooling set temperature range*

In environments such as gyms where people do strenuous exercise, even if the room is cooled to an appropriate temperature, people may feel that it is hot, and they need a cooler air. To satisfy such demands, we have extended the lower limit of the cooling set temperature range from 19–30°C. to 14–30°C.

*Insulation kit (PAC-SK36HK-E) is required when indoor unit is PLA series.

*Availability of this function is depending on outdoor unit, indoor unit and remote controller.

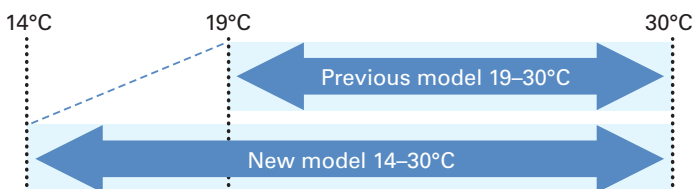

Display of model names and serial numbers*

The model names and serial numbers of the indoor/outdoor units that are connected to the MA smart remote controller can be automatically acquired and displayed through one simple operation. This eliminates the need to directly check each unit and helps with inquiries in the case of an abnormality.

*Availability of this function is depending on outdoor unit, indoor unit and remote controller.

● Model name display (example)

```
Collect model names and S/N
0 OU PUZ-ZM200YKA2
  IU1 PLA-ZM50EA2
  IU2 PLA-ZM50EA2
  IU3 PLA-ZM50EA2
  IU4 PLA-ZM50EA2
```

```
Collect data: ✓
-Address + S/N
```

● Serial number display (example)

```
Collect model names and S/N
0 OU 1ZU00001
  IU1 1ZA00001
  IU2 1ZA00002
  IU3 1ZA00003
  IU4 1ZA00004
```

```
Collect data: ✓
-Address + Model
```

Preliminary error history*

In addition to error history, the history of preliminary abnormalities can be displayed. The feature enables the unit status check during inspection and maintenance.

*Availability of this function is depending on outdoor unit, indoor unit and remote controller.

●Error history (Sample)

Error history		1/4
Error	Unt#	dd/mm/yy
E0	0-1	21/10/20 PM12:34
E0	0-1	20/12/20 AM 1:23
E0	0-1	20/11/20 PM10:55
E0	0-1	20/10/20 PM12:01

Error history menu: ↻

▼ Page ▲ Delete

●Preliminary error history (Sample)

Preliminary error hist.		1/8
Error	Unt#	dd/mm/yy
E0	0-1	21/10/20 PM12:34
E0	0-1	20/12/20 AM 1:23
E0	0-1	20/11/20 PM10:55
E0	0-1	20/10/20 PM12:01

Error history menu: ↻

▼ Page ▲ Delete

Display of power consumption*

It is possible to measure, acquire, and display the amount of energy used by each air conditioning system.

*Availability of this function is depending on outdoor unit, indoor unit and remote controller.

< Data Collection Period >

Time data: Every 30 minutes over the past month

Monthly/daily data: Monthly over the past 14 months

Energy consumption values are calculated from estimated power consumption values according to the operating conditions. They may vary from the actual power consumption values. Please note that the power consumption of optional parts is not included except in the case of optional parts that have their power supplied directly by the outdoor unit.

●Every 30 minutes (example)

Energy data	
2019-1-1	1234.5kWh 1/6
0:30 123.4kWh	2:30 123.4kWh
1:00 123.4kWh	3:00 123.4kWh
1:30 123.4kWh	3:30 123.4kWh
2:00 123.4kWh	4:00 123.4kWh

Return: ↻

- Date + ▼ Page ▲

●Daily (example)

Energy data	
2019-1	123456.7kWh 1/4
31 1234.5kWh	27 1234.5kWh
30 1234.5kWh	26 1234.5kWh
29 1234.5kWh	25 1234.5kWh
28 1234.5kWh	24 1234.5kWh

Return: ↻

▼ Page ▲

●Monthly (example)

Energy data	
▶2019-1	123456.7kWh 1/3
2018-12	123456.7kWh
2018-11	123456.7kWh
2018-10	123456.7kWh
2018-9	123456.7kWh

View daily data: ✓

▼ Cursor ▲

Improved defrosting performance*

*Availability of this function is depending on outdoor unit, indoor unit and remote controller.

Avoiding Simultaneous Defrosting

When each of multiple units is in operation in the same space, these may start defrosting at the same time, resulting in a drop in the room temperature. Therefore, we have developed a new function that controls up to four-refrigerant air conditioning system to avoid simultaneous defrosting. By ensuring that defrosting is only performed by one unit at a time, it is possible to minimize any decrease in room temperature.

Example System Configuration Four sets controlled by a single remote controller

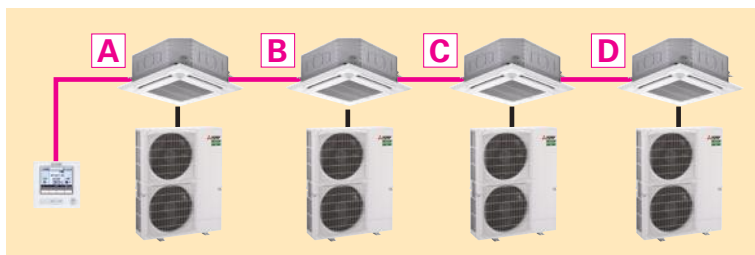

■When All Sets Are Controlled Together

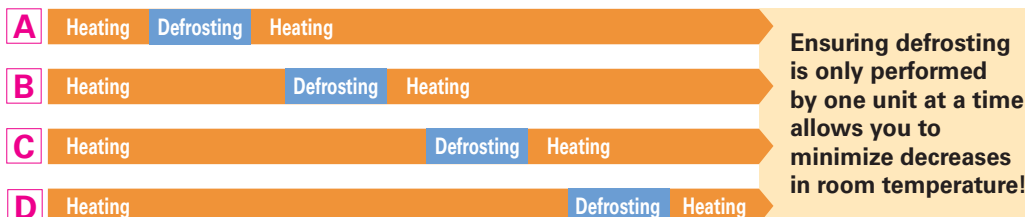

Utilizing IoT for Improved Convenience*

*Availability of IoT functions are depending on MELCloud version.

By connecting to a MAC-5871FE Wi-Fi interface, it is possible to collect data and perform air conditioning control via MELCloud. In addition to basic functions such as turning the power on/off and setting the temperature, it is also possible to acquire data used for maintenance and inspection such as model names, serial numbers, and operation data.

[Basic Operation Functions]

- Operation on/off ●Temperature setting
- Operation mode ●Airflow speed
- Airflow direction etc...

[Data Collection and Display]

- Model name display ●Serial number display
- Collection of operation data
- Energy consumption display etc...

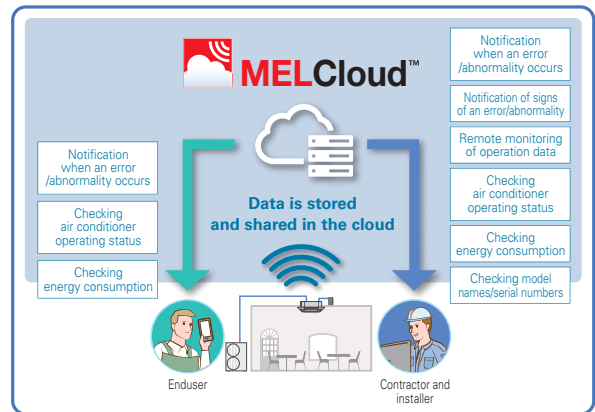

MELCloud System Configuration

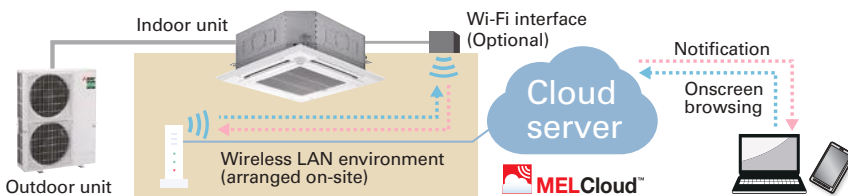

Wi-Fi Adapter (Optional) Installation

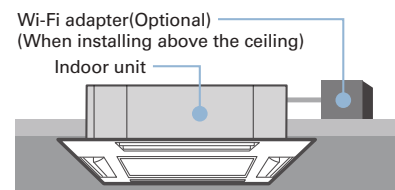

On-Site Installation and Configuration

① Wireless LAN adapter installation

Connect the wireless LAN adapter to the indoor unit PCB and install it above the ceiling.

② Wireless LAN adapter and router connection settings

③ Wireless LAN adapter and server connection settings

Collection of operation data

All the operation data required for maintenance and inspection can be collected in a simple step. This data can then be easily checked via MELcloud. This makes it easy to check the operating status data even in cases when it is difficult to do a visual inspection. This allows you to quickly identify any system malfunctions. This function also helps to improve the quality of installation work and shortening the time required for maintenance and inspection.

Operation data that can be collected (example)

- Compressor frequency ●Compressor operating current ●Outdoor discharge temperature
- Outdoor heat exchanger temperature ●Outdoor air temperature ●Compressor shell temperature
- Sub cool ●Discharge superheat ●Indoor inlet temperature ●Indoor heat exchanger temperature
- Total compressor operating time ●Compressor operation count ●Indoor filter operating time



*1 The total compressor operating time is displayed in units of 10 hours. The compressor operation count is displayed in units of 100.
*2 Indicates the elapsed time since a filter sign reset was performed.

Demand control

It is possible to control air-conditioners to appropriately operate according to the energy supply-demand adjustment by electric power companies and each electricity rate plan of end users.

e.g. <Peak cut control> It is possible to utilize an external demand signal to reduce power consumption during peak hours. By satisfying the need for reducing peak power consumption or shifting consumption to a non-peak period, we have increased the range of options for our customers.

Notification of potential abnormality

The comprehensive analysis of operating data allows the early detection of abnormalities in small functional parts by alerting the operator of any signs of abnormal behaviour. The recognition in advance of abnormalities in each unit further improves the ease of servicing and maintenance. Since this allows a countermeasure to be implemented before the abnormality requires the unit to be completely shut down, it is an effective method for maintaining the unit in its optimum condition.

[Abnormalities That Have Their Signs Monitored]

- Filter blockage ●Drain blockage ●Refrigerant leakage
- Heat exchanger blockage etc...

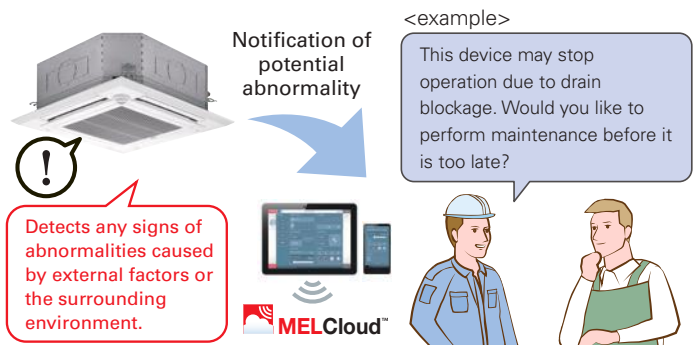

PLA SERIES

R32
R410A
PLA-ZM35/50/60/71/100/125/140EA2



R32
R410A
PLA-M35/50/60/71/100/125/140EA2



A complete line-up including deluxe units that offer added energy savings. The incorporation of "3D total flow" and the "3D i-see Sensor" enhances airflow distribution control, achieving an enhanced level of comfort throughout the room. The synergy of higher energy efficiency and more comfortable room environment results in the utmost user satisfaction.

Deluxe 4-way Cassette Line-up

For users seeking even further energy savings, Mitsubishi Electric now offers deluxe units (PLA-ZM) to complete the line-up of models in this series, from 35-140. Compared to the standard models (PLA-M), deluxe models provide additional energy savings, contributing to a significant reduction in electricity costs.

Line-up

Series	Model	35	50	60	71	100	125	140
R32 R410A	Deluxe 4-way Cassette (PLA-ZM)	●	●	●	●	●	●	●
R32 R410A	Standard 4-way Cassette (PLA-M)	●	●	●	●	●	●	●

Indoor/Outdoor Unit Combinations

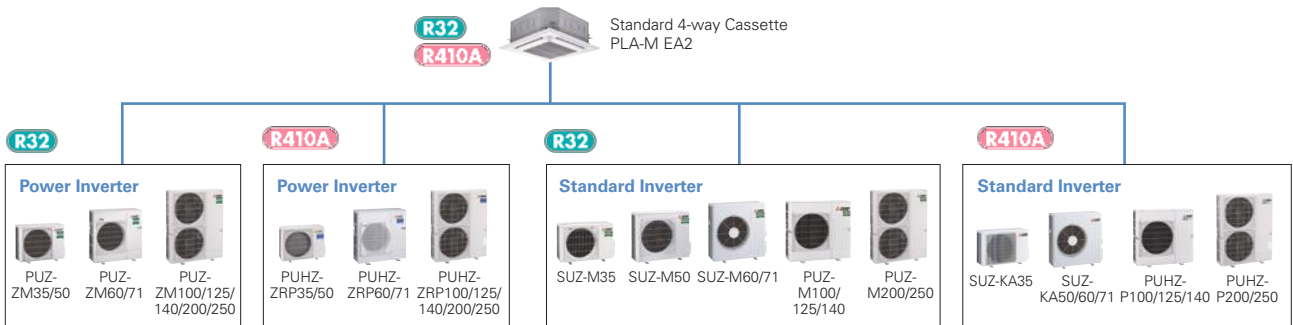
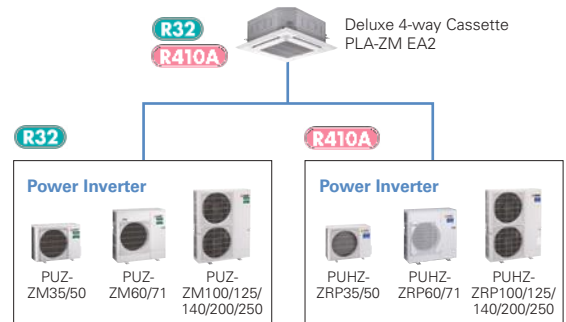

Industry-leading energy efficiency

Introduction of new R32 refrigerant realises improved cooling efficiency. Rating of more than 7.0 achieved for all capacity range. Introduction of new R32 refrigerant reduces energy consumption and realises energy savings.

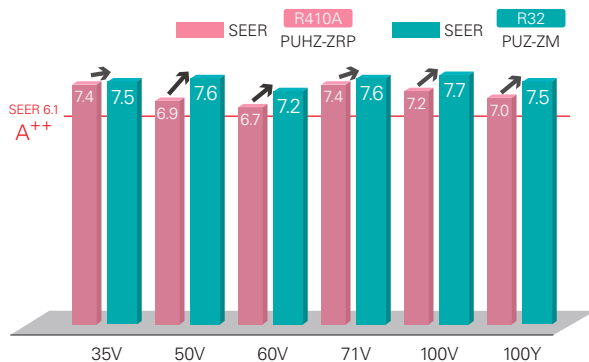

Horizontal Airflow

The new airflow control removes that uncomfortable drafty feeling with the introduction of a horizontal airflow that spreads across the ceiling. The ideal airflow for offices and restaurants.



[Horizontal airflow]
Model name: PLA-ZM140EA2
Ceiling height: 3.2m
Mode: Cooling

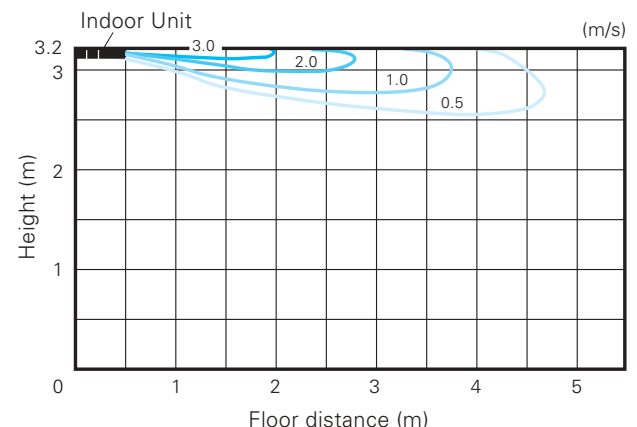

Automatic Grille Lowering Function (PLP-6EAJ, PLP-6EAJE)*

An automatic grille lowering function is available for easy filter maintenance. Special wired and wireless remote controllers can be used to lower the intake grille for maintenance.

*Auto elevation panel(PLP-6EAJ,PLP-6EAJE) cannot be used with Plasma Quad Connect(PAC-SK51TFE) and Insulation kit (PAC-SK36HK-E).



Grille Elevation Remote Controller
(comes with the automatic elevation panel)



Wired Remote Controller



Wireless Remote Controller

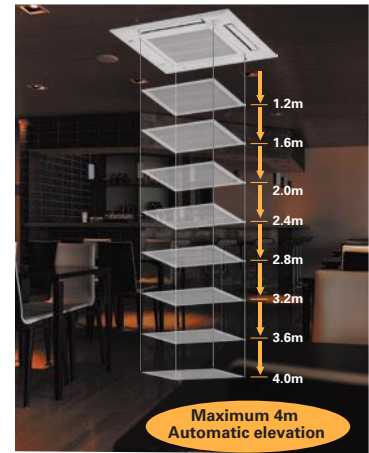

Easy Installation

Electrical box wiring

After reviewing the power supply terminal position in the electrical box, the structure was redesigned to improve connectivity. This has made previously complex wiring work easier.

■ Previous model (B Series)



■ New model (E Series)



Increased space for plumbing work

The top and bottom positions of the liquid and gas pipes have been reversed to allow the gas pipe work, which requires more effort, to be completed first. Further, through structural innovations related to the space around the pipes, the area where the spanner can be moved has been increased, thus improving liquid pipe work and enabling it to be completed smoothly.

■ Previous model (B Series)

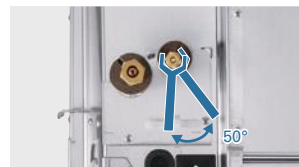

■ New model (E Series)



Temporary hanging hook

The structure of the panel has been revised and is now equipped with a temporary hanging hook. This has improved work efficiency during panel installation.



No need to remove screws

Installation is possible without removing the screws for the corner panel and the control box, simply loosen them. This lowers the risk of losing screws.

■ Corner panel



■ Control box cover



Lightweight decorative panel

After reviewing the structure and materials, weight has been reduced approximately 20% compared to the previous model, reducing the burden of installation.



3D i-see Sensor for S & P SERIES

Detects number of people

3D i-see Sensor detects the number of people in the room and sets the air-conditioning power accordingly. This makes automatic power-saving operation possible in places where the number of people entering and exiting is large. Additionally, when the area is continuously unoccupied, the system switches to a more enhanced power-saving mode. Depending on the setting, it will save additional capacity or stop operation altogether.

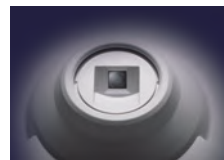

Detects number of people

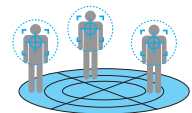

Detects people's position



Detects people's position

Once the position of a person is detected, the duct angle of the vane is automatically adjusted in that direction. Each vane can be independently set to "block wind" or "not block wind" according to taste.

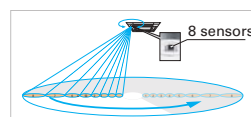

Detects position and number of people

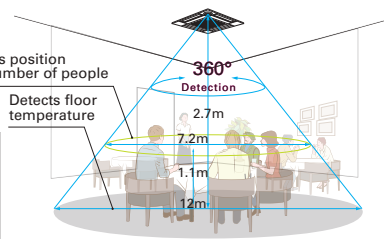

Floor surface *In case of a 2.7m ceiling

Detects number of people (3D i-see Sensor)

Room occupancy energy-saving mode

The 3D i-see Sensor detects the number of people in the room. It then calculates the occupancy rate based on the maximum number of people in the room up to that point in time in order to save air-conditioning power. When the occupancy rate is approximately 30%, air-conditioning power equivalent to 1°C during both cooling and heating operation is saved. The temperature is controlled according to the number of people.

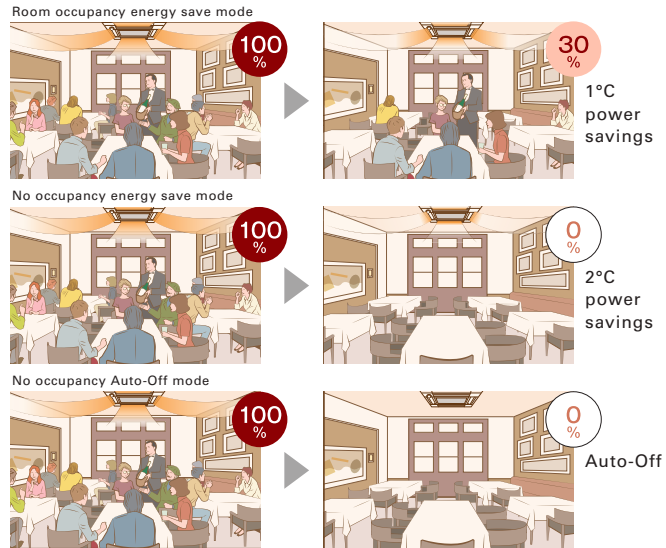

*PAR-41MAA is required for each setting

No occupancy energy-saving mode

When 3D i-see Sensor detects that no one is in the room, the system is switched to a pre-set power-saving mode. If the room remains unoccupied for more than 60min, air-conditioning power equivalent to 2°C during both cooling and heating operation is saved. This contributes to preventing waste in terms of heating and cooling.

No occupancy Auto-Off mode*

When the room remains unoccupied for a pre-set period of time, the air conditioner turns off automatically, thereby providing even greater power savings. The time until operation is stopped can be set in intervals of 10min, ranging from 60 to 180 min.

* When MA Remote Controller is used to control multiple refrigerant systems, "No occupancy Auto-Off mode" cannot be used.

Detects people's position (3D i-see Sensor)

Direct/Indirect settings*

Some people do not like the feel of wind, some want to be warm from head to toe. People's likes and dislikes vary. With the 3D i-see Sensor, it is possible to choose to block or not block to the wind for each vane.

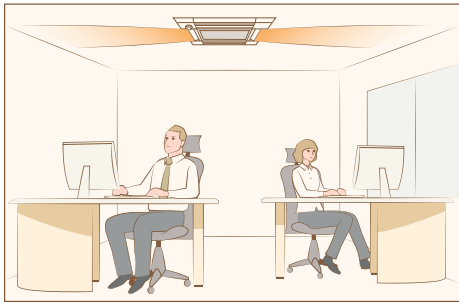

*PAR-41MAA or PAR-SL101A-E is required for each setting.

Seasonal airflow*

<When cooling>

Saves energy while keeping a comfortable effective temperature by automatically switching between ventilation and cooling. When a pre-set temperature is reached, the air conditioning unit switches to swing fan operation to maintain the effective temperature. This clever function contributes to keeping a comfortable coolness.

<When heating>

The air conditioning unit automatically switches between circulator and heating. Wasted heat that accumulates near the ceiling is reused via circulation. When a pre-set temperature is reached the air conditioner switches from heating to circulator and blows air in the horizontal direction. It pushes down the warm air that has gathered near the ceiling to people's height, thereby providing smart heating.

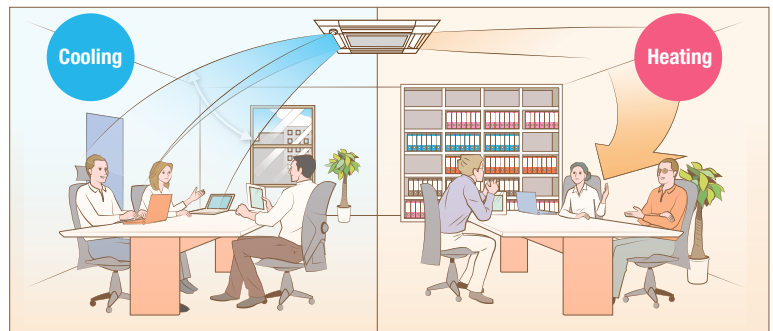

*PAR-41MAA is required for each setting.

3D Total Flow*

3D Total Flow is an innovative function. Our original 3D i-see sensor detects the temperature of the floor, and then the newly installed 3D Total Flow unit automatically controls the airflow in the left/right directions in a smart manner.

*3D Total Flow unit(PLP-U160ELR-E) cannot be used with Plasma Quad Connect(PAC-SK51TFE), Insulation kit(PAC-SK36HK-E), Shutter Plate(PAC-SJ37SP-E), Multi functional casement(PAC-SJ41TM-E) and High-efficiency filter element(PAC-SH59KF-E)

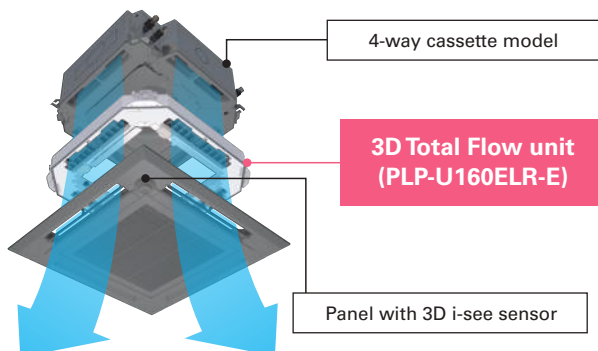

Horizontal louver (3D Total Flow)

In addition to the ability of conventional models to control airflow in the vertical direction, the adoption of a horizontal louver unit allows each outlet to blow air over a horizontal angle of 90 degrees. The combination of four outlets delivers 360° airflow control around the entire circumference. This now makes it possible to blow air in diagonal directions which eliminates temperature irregularities.

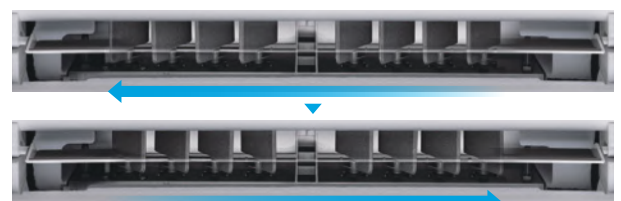

louvers can provide horizontal airflow control.

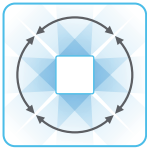

Swinging

Since airflow can be controlled in the horizontal and vertical directions, you can efficiently make the entire room comfortable.

Horizontal, vertical, and diagonal airflow delivered to every corner

The combination of the vertical vanes with the horizontal louver unit makes it possible to direct airflow in any direction. This quickly makes the entire room comfortable, even when diagonal airflow is necessary.

Without 3D Total Flow



There are some areas that cannot receive air through vertical airflow control.

With 3D Total Flow

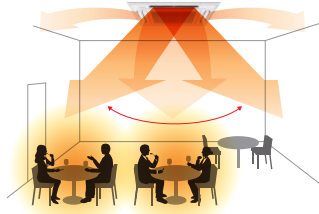

Swinging in both the vertical and horizontal directions provides a pleasant breeze throughout the room.

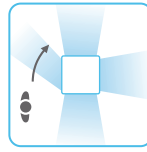

Indirect mode

When set to "Indirect" mode, the system detects the position of a person and maintains comfort while diverting airflow away from them.

Prevents direct airflow and keeps you comfortable

This function prevents people from being directly exposed to airflow while still ensuring comfort. The "Indirect" mode of 3D Total Flow keeps the downward airflow while avoiding direct blow to people, delivering a pleasant warmth.

Without 3D Total Flow

Models that are only equipped with vertical vanes need to swing the airflow upward to avoid people. This makes it difficult to warm up the surrounding space.



With 3D Total Flow

Now, it is easier to warm the surrounding space while still ensuring people do not receive direct blow.



*If people are present throughout the entire airflow range of an outlet, the airflow is shifted horizontally to avoid direct airflow.

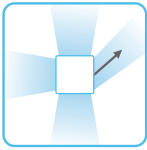

Targeting

The system can detect spaces with uneven temperatures and target them by sending air even if they are in a diagonal direction.

Detects and targets areas with uneven temperatures

3D i-see sensor detects areas with uneven temperatures, even if they are caused by the installation orientation of the air conditioner or the influence of strong sunlight. Efficient air conditioning is possible thanks to the ability to send focused airflow to such areas, even those in a diagonal position.

Without 3D Total Flow

Depending on application, conventional systems may take a long time to cool down hot spots.



With 3D Total Flow

The new system efficiently eliminates hot spots by using targeted airflow.

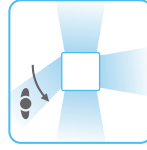
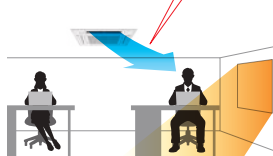

Direct mode

When set to "Direct" mode, the system detects the position and diverts airflow towards wherever they are located.

Delivers airflow even in diagonal directions

You can freely turn on "Direct" mode depending on personal preference. This allows for air conditioning in diagonal directions which was difficult for models that could only swing the airflow up and down. This feature is perfect for when you come back home on a hot day.

Without 3D Total Flow

It is difficult to direct airflow in diagonal directions when only using vertical vanes.

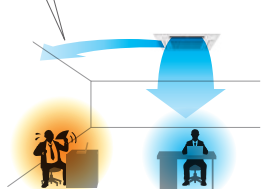

With 3D Total Flow

Ensures comfort even when you are located diagonally from an outlet.

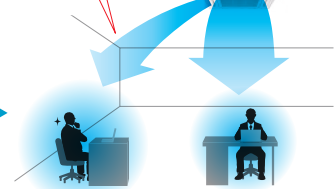

Connectable to *Plasma Quad Connect**

The optional Plasma Quad Connect PAC-SK51FTE can be installed on the indoor units.

*Plasma Quad Connect(PAC-SK51FTE) cannot be used with PLP-U160ELR-E(3D Total Flow unit), Insulation kit (PAC-SK36HK-E), Auto elevation panel(PLP-6EAJ, PLP-6EAJE), Multi functional casement(PAC-SJ41TM-E) and High-efficiency filter element(PAC-SH59KF-E).

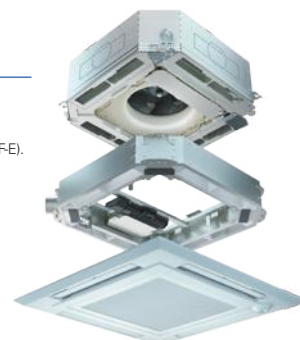

SERIES SELECTION

Power Inverter Series



Indoor Unit

R32
R410A



Panel

PLA-ZM35/50/60/71/100/125/140EA2

Panel	With Signal Receiver	With 3D i-see Sensor	With Wireless Remote Controller	With Auto Elevation
PLP-6EA				
PLP-6EAL	✓			
PLP-6EAE		✓		
PLP-6EALM2	✓	✓		
PLP-6EAJ*	✓	✓		✓
PLP-6EAJE*	✓	✓		✓
PLP-6EALM2	✓	✓	✓	
PLP-6EALME2	✓	✓	✓	

*Auto elevation panel(PLP-6EAJ,PLP-6EAJE) cannot be used with Plasma Quad Connect(PAC-SK51FT-E) and Insulation kit (PAC-SK36HK-E).

Outdoor Unit

R32

For Single



R32

For Multi (Twin/Triple/Quadruple)



PUZ-ZM71 PUZ-ZM100/125/140/200/250

3D Total Flow Unit

PLP-U160ELR-E (optional)



Remote Controller



Optional



Optional



Optional



* Enclosed in PLP-6EALM2/PLP-6EALME2

PLA-ZM EA2 Indoor Unit Combinations

Indoor unit combinations shown below are possible.

Indoor Unit Combination	Outdoor Unit Capacity																			
	For Single									For Twin						For Triple			For Quadruple	
	35	50	60	71	100	125	140	200	250	71	100	125	140	200	250	140	200	250	200	250
Power Inverter (PUZ-ZM)	35x1	50x1	60x1	71x1	100x1	125x1	140x1	-	-	35x2	50x2	60x2	71x2	100x2	125x2	50x3	60x3	71x3	50x4	60x4
Distribution Pipe	-	-	-	-	-	-	-	-	-	MSDD-50TR2-E			MSDD-50WR2-E			MSDF-111R3-E			MSDF-111R2-E	

SERIES SELECTION

Standard Inverter Series



Indoor Unit

R32
R410A



Panel

PLA-M35/50/60/71/100/125/140EA2

Panel	With Signal Receiver	With 3D i-see Sensor	With Wireless Remote Controller	With Auto Elevation
PLP-6EA				
PLP-6EAL	✓			
PLP-6EAE		✓		
PLP-6EALM2	✓	✓		
PLP-6EAJ*	✓	✓		✓
PLP-6EAJE*	✓	✓		✓
PLP-6EALM2	✓	✓	✓	
PLP-6EALME2	✓	✓	✓	

*Auto elevation panel(PLP-6EAJ,PLP-6EAJE) cannot be used with Plasma Quad Connect(PAC-SK51FT-E) and Insulation kit (PAC-SK36HK-E).

Outdoor Unit

R32

For Single



R32

For Multi (Twin/Triple/Quadruple)



PUZ-M100/125/140 PUZ-M200/250

3D Total Flow Unit

PLP-U160ELR-E* (optional)

*SUZ combination is not available.



Remote Controller



Optional



Optional



Optional



* Enclosed in PLP-6EALM2/PLP-6EALME2

PLA-M EA2 Indoor Unit Combinations

Indoor unit combinations shown below are possible.

Indoor Unit Combination	Outdoor Unit Capacity																			
	For Single									For Twin						For Triple			For Quadruple	
	35	50	60	71	100	125	140	200	250	71	100	125	140	200	250	140	200	250	200	250
Standard Inverter (SUZ & PUZ-M)	35x1	50x1	60x1	71x1	100x1	125x1	140x1	-	-	50x2	60x2	71x2	100x2	125x2	50x3	60x3	71x3	50x4	60x4	
Distribution Pipe	-	-	-	-	-	-	-	-	-	MSDD-50TR2-E			MSDD-50WR2-E			MSDF-111R3-E			MSDF-111R2-E	

PLA-ZM SERIES

POWER INVERTER



Type		Inverter Heat Pump										
Indoor Unit		PLA-M35EA2	PLA-M50EA2	PLA-M60EA2	PLA-M71EA2	PLA-M100EA2	PLA-M100EA2	PLA-M125EA2	PLA-M125EA2	PLA-M140EA2	PLA-M140EA2	PLA-M140EA2
Outdoor Unit		PUZ-M35VKA2	PUZ-M50VKA2	PUZ-M60VHA2	PUZ-M71VHA2	PUZ-M100VKA2	PUZ-M100VKA2	PUZ-M125VKA2	PUZ-M125VKA2	PUZ-M140VKA2	PUZ-M140VKA2	PUZ-M140VKA2
Refrigerant (*)		R32										
Power Supply		Outdoor power supply										
Source		VKA-VHA:230/Single/50, YKA:400/Three/50										
Outdoor(V/Phase/Hz)												
Cooling	Capacity	Rated	3.6	5.0	6.1	7.1	9.5	9.5	12.5	12.5	13.4	13.4
		Min-Max	1.6 - 4.5	2.3 - 5.6	2.7 - 6.5	3.3 - 8.1	4.9 - 11.4	4.9 - 11.4	5.5 - 14.0	5.5 - 14.0	6.2 - 15.0	6.2 - 15.0
	Total Input	Rated	0.705	1.106	1.452	1.651	2.159	2.159	3.378	3.378	3.722	3.722
	EER		5.10	4.52	4.20	4.30	4.40	4.40	3.70	3.70	3.60	3.60
	Design load		3.6	5.0	6.1	7.1	9.5	9.5	12.5	12.5	13.4	13.4
Heating	Capacity	Rated	4.1	6.0	7.0	8.0	11.2	11.2	14.0	14.0	16.0	16.0
		Min-Max	1.6 - 5.2	2.5 - 7.3	2.8 - 8.2	3.5 - 10.2	4.5 - 14.0	4.5 - 14.0	5.0 - 16.0	5.0 - 16.0	5.7 - 18.0	5.7 - 18.0
	Total Input	Rated	0.820	1.363	1.707	1.818	2.604	2.604	3.674	3.674	4.312	4.312
	COP		5.00	4.40	4.10	4.40	4.30	4.30	3.81	3.81	3.71	3.71
	Design load		2.5	3.8	4.4	4.7	7.8	7.8	11.2	11.2	13.4	13.4

*1 Refrigerant leakage contributes to climate change. Refrigerant with lower global warming potential (GWP) would contribute less to global warming than a refrigerant with higher GWP if leaked to the atmosphere. This appliance contains a refrigerant fluid with a GWP equal to 560. This means that if 1 kg of this refrigerant fluid would be leaked to the atmosphere, the impact on global warming would be 560 times higher than 1 kg of CO₂ over a period of 100 years. Never try to interfere with the refrigerant circuit yourself or disassemble the product yourself and always ask a professional. The GWP of R32 is 675 in the IPCC 4th Assessment Report.

*2 Energy consumption based on standard test results. Actual energy consumption will depend on how the appliance is used and where it is located.

*3 Optional air protection guide is required where ambient temperature is lower than -5°C.

*4 SEER and SCOP are based on 2009/125/EC:Energy-related Products Directive and Regulation(EU) No206/2012. *5 Joint pipe is required depending on installed refrigerant pipes, outdoor units and indoor units.

PLA-M SERIES

STANDARD INVERTER



Type		Inverter Heat Pump										
Indoor Unit		PLA-M35EA2	PLA-M50EA2	PLA-M60EA2	PLA-M71EA2	PLA-M100EA2	PLA-M100EA2	PLA-M125EA2	PLA-M125EA2	PLA-M140EA2	PLA-M140EA2	PLA-M140EA2
Outdoor Unit		SUZ-M35VA	SUZ-M50VA	SUZ-M60VA	SUZ-M71VA	SUZ-M100VKA2	SUZ-M100VKA2	SUZ-M125VKA2	SUZ-M125VKA2	SUZ-M140VKA2	SUZ-M140VKA2	SUZ-M140VKA2
Refrigerant (*)		R32										
Power Supply		Outdoor power supply										
Source		VA-VKA:230/Single/50, YKA:400/Three/50										
Outdoor(V/Phase/Hz)												
Cooling	Capacity	Rated	3.6	5.5	6.1	7.1	9.5	9.5	12.1	12.1	13.4	13.4
		Min-Max	0.8 - 3.9	1.2 - 5.6	1.6 - 6.3	2.2 - 8.1	4.0 - 10.6	4.0 - 10.6	5.8 - 13.0	5.8 - 13.0	5.8 - 14.1	5.8 - 14.1
	Total Input	Rated	0.900	1.617	1.848	1.918	2.714	2.714	4.019	4.019	4.962	4.962
	EER		4.00	3.40	3.30	3.70	3.50	3.50	3.01	3.01	2.70	2.70
	Design load		3.6	5.5	6.1	7.1	9.5	9.5	12.1	12.1	13.4	13.4
Heating	Capacity	Rated	4.1	6.0	7.0	8.0	11.2	11.2	13.5	13.5	15.0	15.0
		Min-Max	1.0 - 5.0	1.5 - 7.2	1.6 - 8.0	2.0 - 10.2	2.8 - 12.5	2.8 - 12.5	4.1 - 15.0	4.1 - 15.0	4.2 - 15.8	4.2 - 15.8
	Total Input	Rated	0.976	1.734	1.842	2.216	3.018	3.018	3.638	3.638	4.398	4.398
	COP		4.20	3.46	3.80	3.61	3.71	3.71	3.71	3.71	3.41	3.41
	Design load		2.6	4.3	4.6	5.8	8.0	8.0	11.2	11.2	13.4	13.4

*1 Refrigerant leakage contributes to climate change. Refrigerant with lower global warming potential (GWP) would contribute less to global warming than a refrigerant with higher GWP if leaked to the atmosphere. This appliance contains a refrigerant fluid with a GWP equal to 560. This means that if 1 kg of this refrigerant fluid would be leaked to the atmosphere, the impact on global warming would be 560 times higher than 1 kg of CO₂ over a period of 100 years. Never try to interfere with the refrigerant circuit yourself or disassemble the product yourself and always ask a professional. The GWP of R32 is 675 in the IPCC 4th Assessment Report.

*2 Energy consumption based on standard test results. Actual energy consumption will depend on how the appliance is used and where it is located.

*3 Optional air protection guide is required where ambient temperature is lower than -5°C.

*4 SEER and SCOP are based on 2009/125/EC:Energy-related Products Directive and Regulation(EU) No206/2012. *5 Joint pipe is required depending on installed refrigerant pipes, outdoor units and indoor units.

PLA-M SERIES

POWER INVERTER



Type			Inverter Heat Pump											
Indoor Unit			PLA-M35EA2	PLA-M50EA2	PLA-M60EA2	PLA-M71EA2	PLA-M100EA2	PLA-M100EA2	PLA-M100EA2	PLA-M125EA2	PLA-M125EA2	PLA-M140EA2	PLA-M140EA2	
Outdoor Unit			PUZ-ZM35VKA2	PUZ-ZM50VKA2	PUZ-ZM60VHA2	PUZ-ZM71VHA2	PUZ-ZM100VKA2	PUZ-ZM100VKA2	PUZ-ZM100VKA2	PUZ-ZM125VKA2	PUZ-ZM125VKA2	PUZ-ZM140VKA2	PUZ-ZM140VKA2	
Refrigerant ⁽¹⁾			R32											
Power Supply			Outdoor power supply											
Source			VKA - VHA:230/Single/50, YKA:400/Three/50											
Outdoor(V/Phase/Hz)														
Cooling	Capacity	Rated	kW	3.6	5.0	6.1	7.1	9.5	9.5	12.5	12.5	13.4	13.4	
		Min-Max	kW	1.6 - 4.5	2.3 - 5.6	2.7 - 6.5	3.3 - 8.1	4.9 - 11.4	4.9 - 11.4	5.5 - 14.0	5.5 - 14.0	6.2 - 15.0	6.2 - 15.0	
	Total Input	Rated	kW	0.751	1.175	1.523	1.716	2.209	2.209	3.396	3.396	3.746	3.746	
	EER			4.79	4.25	4.00	4.14	4.30	4.30	3.68	3.68	3.58	3.58	
	Design load		kW	3.6	5.0	6.1	7.1	9.5	9.5	-	-	-	-	
	Annual electricity consumption ⁽²⁾		kWh/a	172	234	301	336	437	448	-	-	-	-	
Heating (Average Season)	SEER ⁽³⁾			7.3	7.4	7.1	7.4	7.6	7.4	-	-	-	-	
		Energy efficiency class		A++	A++	A++	A++	A++	A++	-	-	-	-	
	Capacity	Rated	kW	4.1	6.0	7.0	8.0	11.2	11.2	14.0	14.0	16.0	16.0	
		Min-Max	kW	1.6 - 5.2	2.5 - 7.3	2.8 - 8.2	3.5 - 10.2	4.5 - 14.0	4.5 - 14.0	5.0 - 16.0	5.0 - 16.0	5.7 - 18.0	5.7 - 18.0	
	Total Input	Rated	kW	0.890	1.581	1.863	2.014	2.685	2.685	3.773	3.773	4.365	4.365	
	COP			4.61	3.79	3.76	3.97	4.17	4.17	3.71	3.71	3.67	3.67	
	Design load		kW	2.5	3.8	4.4	4.7	7.8	7.8	-	-	-	-	
	Declared Capacity	at reference design temperature	kW	2.5 (-10°C)	3.8 (-10°C)	4.4 (-10°C)	4.7 (-10°C)	7.8 (-10°C)	7.8 (-10°C)	-	-	-	-	
		at bivalent temperature	kW	2.5 (-10°C)	3.8 (-10°C)	4.4 (-10°C)	4.7 (-10°C)	7.8 (-10°C)	7.8 (-10°C)	-	-	-	-	
	Back up heating capacity	at operation limit temperature	kW	2.1 (-11°C)	3.7 (-11°C)	2.8 (-20°C)	3.4 (-20°C)	5.8 (-20°C)	5.8 (-20°C)	-	-	-	-	
		kW	0.0	0.0	0.0	0.0	0.0	0.0	-	-	-	-		
Annual electricity consumption ⁽²⁾		kWh/a	798	1187	1422	1429	2496	2497	-	-	-	-		
SCOP ⁽⁴⁾			4.3	4.4	4.3	4.6	4.3	4.3	-	-	-	-		
Operating	Current(Max)		A	13.2	13.2	19.2	19.3	20.5	8.5	27.2	9.7	30.7	12.5	
		Energy efficiency class		A	A	A	A	A	A	-	-	-	-	
Indoor Unit	Input [cooling / Heating]	Rated	kW	0.03 / 0.03	0.03 / 0.03	0.03 / 0.03	0.04 / 0.04	0.07 / 0.07	0.07 / 0.07	0.10 / 0.10	0.10 / 0.10	0.10 / 0.10	0.10 / 0.10	
	Operating Current(Max)		A	0.20	0.22	0.24	0.27	0.46	0.46	0.66	0.66	0.66	0.66	
	Dimensions	H*V*D	mm		258-840-840	<40-950-950>				298-840-840	<40-950-950>			
	Weight		kg	19 <6>	19 <6>	21 <6>	21 <6>	24 <6>	24 <6>	26 <6>	26 <6>	26 <6>	26 <6>	
	Air Volume (Lo-Mid-Hi)		m³/min	11-13-15-16	12-14-16-18	12-14-16-18	14-17-19-21	19-23-26-29	19-23-26-29	21-25-28-31	21-25-28-31	24-26-29-32	24-26-29-32	
	Sound Level (Lo-Mid-Hi) (SPL)		dB(A)	26-28-29-31	27-29-31-32	27-29-31-32	28-30-32-34	31-34-37-40	31-34-37-40	33-37-41-44	33-37-41-44	36-39-42-44	36-39-42-44	
	Sound Level (PWL)		dB(A)	51	54	54	56	61	61	65	65	65	65	
	Outdoor Unit	Dimensions	H*V*D	mm	630-809-300	630-809-300	943-950-330(+25)	943-950-330(+25)	1338-1050-330(+40)	1338-1050-330(+40)	1338-1050-330(+40)	1338-1050-330(+40)	1338-1050-330(+40)	
		Weight		kg	46	46	67	67	105	111	105	114	105	
		Air Volume	Cooling	m³/min	45	45	55	55	110	110	120	120	120	120
Heating			m³/min	45	45	55	55	110	110	120	120	120	120	
Sound Level (SPL)		Cooling	dB(A)	44	44	47	47	49	49	50	50	50	50	
		Heating	dB(A)	46	46	49	49	51	51	52	52	52	52	
Sound Level (PWL)		Cooling	dB(A)	65	65	67	67	69	69	70	70	70	70	
		Heating	dB(A)	65	65	67	67	69	69	70	70	70	70	
Operating Current(Max)			A	13	13	19	19	20	8	26.5	9	30	11.8	
Breaker Size			A	16	16	25	25	32	16	32	16	40	16	
Ext.Piping	Diameter ⁽⁵⁾	Liquid/Gas	mm	6.35 / 12.7	6.35 / 12.7	9.52 / 15.88	9.52 / 15.88	9.52 / 15.88	9.52 / 15.88	9.52 / 15.88	9.52 / 15.88	9.52 / 15.88		
	Max.Length	Out-In	m	50	50	55	55	100	100	100	100	100		
	Max.Height	Out-In	m	30	30	30	30	30	30	30	30	30		
Guaranteed Operating Range (Outdoor)	Cooling ⁽³⁾	°C	-15 ~ +46	-15 ~ +46	-15 ~ +46	-15 ~ +46	-15 ~ +46	-15 ~ +46	-15 ~ +46	-15 ~ +46	-15 ~ +46	-15 ~ +46		
	Heating	°C	-11 ~ +21	-11 ~ +21	-20 ~ +21	-20 ~ +21	-20 ~ +21	-20 ~ +21	-20 ~ +21	-20 ~ +21	-20 ~ +21	-20 ~ +21		

*1 Refrigerant leakage contributes to climate change. Refrigerant with lower global warming potential (GWP) would contribute less to global warming than a refrigerant with higher GWP, if leaked to the atmosphere. This appliance contains a refrigerant fluid with a GWP equal to 550. This means that if 1 kg of this refrigerant fluid would be leaked to the atmosphere, the impact on global warming would be 550 times higher than 1 kg of CO₂, over a period of 100 years. Never try to interfere with the refrigerant circuit yourself or disassemble the product yourself and always ask a professional. The GWP of R32 is 675 in the IPCC 4th Assessment Report.

*2 Energy consumption based on standard test results. Actual energy consumption will depend on how the appliance is used and where it is located.

*3 Optional air protection guide is required where ambient temperature is lower than -5°C.

*4 SEER and SCOP are based on 2009/125/EC: Energy-related Products Directive and Regulation(EU) No206/2012.

*5 Joint pipe is required depending on installed refrigerant pipes, outdoor units and indoor units.

SERIES SELECTION

Power Inverter Series



Indoor Unit

R32
R410A



PLA-ZM35/50/60/71/100/125/140EA2

Panel

Panel	With Signal Receiver	With 3D i-see Sensor	With Wireless Remote Controller	With Auto Elevation
PLP-6EA				
PLP-6EAL	✓			
PLP-6EAE		✓		
PLP-6EALAE	✓	✓		
PLP-6EAJ	✓			✓
PLP-6EAJE	✓	✓		✓
PLP-6EALM2	✓		✓	
PLP-6EALME2	✓	✓	✓	

Outdoor Unit

R410A

For Single



PUHZ-ZRP35/50



PUHZ-ZRP60/71



PUHZ-ZRP100/125/140

R410A

For Multi
(Twin/Triple/Quadruple)



PUHZ-ZRP71



PUHZ-ZRP100/125/140/200/250

Remote Controller



Optional



Optional



Optional



*

* Enclosed in PLP-6EALM2/PLP-6EALME2

PLA-ZM EA2 Indoor Unit Combinations Indoor unit combinations shown below are possible.

Indoor Unit Combination	Outdoor Unit Capacity																			
	For Single									For Twin					For Triple			For Quadruple		
	35	50	60	71	100	125	140	200	250	71	100	125	140	200	250	140	200	250	200	250
Power Inverter (PUHZ-ZRP)	35x1	50x1	60x1	71x1	100x1	125x1	140x1	-	-	35x2	50x2	60x2	71x2	100x2	125x2	50x3	60x3	71x3	50x4	60x4
Distribution Pipe	-	-	-	-	-	-	-	-	-	MSDD-50TR-E			MSDD-50WR-E		MSDT-111R-E			MSDF-1111R-E		

SERIES SELECTION

Standard Inverter Series



Indoor Unit

R410A



PLA-M35/50/60/71/100/125/140EA2

Panel

Panel	With Signal Receiver	With 3D i-see Sensor	With Wireless Remote Controller	With Auto Elevation
PLP-6EA				
PLP-6EAL	✓			
PLP-6EAE		✓		
PLP-6EALAE	✓	✓		
PLP-6EAJ	✓			✓
PLP-6EAJE	✓	✓		✓
PLP-6EALM2	✓		✓	
PLP-6EALME2	✓	✓	✓	

Outdoor Unit

R410A

For Single



SUZ-KA35



SUZ-KA50/60/71



PUHZ-P100/125/140

R410A

For Multi
(Twin/Triple/Quadruple)



PUHZ-P100/125/140



PUHZ-P200/250

Remote Controller



Optional



Optional



Optional



*

* Enclosed in PLP-6EALM2/PLP-6EALME2

PLA-M EA2 Indoor Unit Combinations Indoor unit combinations shown below are possible.

Indoor Unit Combination	Outdoor Unit Capacity																			
	For Single									For Twin					For Triple			For Quadruple		
	35	50	60	71	100	125	140	200	250	71	100	125	140	200	250	140	200	250	200	250
Standard Inverter (SUZ & PUHZ-P)	35x1	50x1	60x1	71x1	100x1	125x1	140x1	-	-	-	50x2	60x2	71x2	100x2	125x2	50x3	60x3	71x3	50x4	60x4
Distribution Pipe	-	-	-	-	-	-	-	-	-	MSDD-50TR-E			MSDD-50WR-E		MSDT-111R-E			MSDF-1111R-E		

PLA-ZM SERIES

POWER INVERTER



Type		Inverter Heat Pump												
Indoor Unit		PLA-M35EA2	PLA-M50EA2	PLA-M60EA2	PLA-M71EA2	PLA-M100EA2	PLA-M125EA2	PLA-M152EA2	PLA-M140EA2	PLA-M140EA2	PLA-M140EA2	PLA-M140EA2		
Outdoor Unit		PUHZ-ZRP35KA2	PUHZ-ZRP50KA2	PUHZ-ZRP60HA2	PUHZ-ZRP71VA2	PUHZ-ZRP100KA3	PUHZ-ZRP125KA3	PUHZ-ZRP152KA3	PUHZ-ZRP140KA3	PUHZ-ZRP140KA3	PUHZ-ZRP140KA3	PUHZ-ZRP140KA3		
Refrigerant ⁽¹⁾		R410A												
Power Supply		Outdoor power supply VKA VHA:230/Single/50, YKA:400/Three/50												
Cooling	Capacity	Rated	kW	3.6	5.0	6.1	7.1	9.5	9.5	12.5	12.5	13.4	13.4	
		Min-Max	kW	1.6 - 4.5	2.3 - 5.6	2.7 - 6.5	3.3 - 8.1	4.9 - 11.4	4.9 - 11.4	5.5 - 14.0	5.5 - 14.0	6.2 - 15.0	6.2 - 15.0	
	Total Input	Rated	kW	0.782	1.330	1.660	1.790	2.200	2.200	3.846	3.846	4.364	4.364	
	EER	Rated		4.60	3.75	3.66	3.95	4.32	4.32	3.25	3.25	3.07	3.07	
Heating	Capacity	Rated	kW	4.1	6.0	7.0	8.0	11.2	11.2	14.0	14.0	16.0	16.0	
		Min-Max	kW	1.6 - 5.2	2.5 - 7.3	2.8 - 8.2	3.5 - 10.2	4.5 - 14.0	4.5 - 14.0	5.0 - 16.0	5.0 - 16.0	5.7 - 18.0	5.7 - 18.0	
	Total Input	Rated	kW	0.850	1.550	1.890	1.900	2.600	2.600	3.674	3.674	4.848	4.848	
	COP	Rated		4.82	3.85	3.70	4.20	4.31	4.31	3.81	3.81	3.30	3.30	
Energy efficiency class	Design load		kW	2.5	3.8	4.4	4.7	7.8	7.8	—	—	—	—	
	Declared Capacity	at reference design temperature	kW	2.5 (-10°C)	3.8 (-10°C)	4.4 (-10°C)	4.7 (-10°C)	7.8 (-10°C)	7.8 (-10°C)	—	—	—	—	
		at bivalent temperature	kW	2.5 (-10°C)	3.8 (-10°C)	4.4 (-10°C)	4.7 (-10°C)	7.8 (-10°C)	7.8 (-10°C)	—	—	—	—	
		at operation limit temperature	kW	2.1 (-11°C)	3.7 (-11°C)	2.8 (-20°C)	3.5 (-20°C)	5.8 (-20°C)	5.8 (-20°C)	—	—	—	—	
Energy efficiency class	Back up heating capacity		kW	0.0	0.0	0.0	0.0	0.0	0.0	—	—	—	—	
	Annual electricity consumption ⁽²⁾		kWh/a	713	1108	1335	1337	2223	2224	—	—	—	—	
	SCOP ⁽⁴⁾			4.9	4.8	4.6	4.9	4.9	—	—	—	—	—	
	Operating Current(Max)		A	13.2	13.2	19.2	19.3	27.0	27.0	8.5	27.0	10.0	28.7	13.7
Indoor Unit	Input [cooling / Heating]	Rated	kW	0.03 / 0.03	0.03 / 0.03	0.03 / 0.03	0.05 / 0.05	0.07 / 0.07	0.07 / 0.07	0.08 / 0.08	0.08 / 0.08	0.10 / 0.10	0.10 / 0.10	
	Operating Current(Max)		A	0.21	0.22	0.22	0.34	0.47	0.47	0.52	0.52	0.66	0.66	
	Dimensions	H*W*D	mm	258-840-840 <40-950-950>										
	Weight		kg	21 <5> 21 <5> 21 <5> 21 <5> 26 <5> 26 <5> 26 <5> 26 <5> 26 <5> 26 <5>										
Outdoor Unit	Air Volume (Lo-Mi2-Mi1-Hi)		m³/min	11-13-15-16	12-14-16-18	12-14-16-18	17-19-21-23	19-22-25-28	19-22-25-28	21-24-26-29	21-24-26-29	24-26-29-32	24-26-29-32	
	Sound Level (Lo-Mi2-Mi1-Hi) (SPL)		dB(A)	26-28-29-31	27-29-31-32	27-29-31-32	28-30-33-36	31-34-37-40	31-34-37-40	33-36-39-41	33-36-39-41	36-39-42-44	36-39-42-44	
	Sound Level (PWL)		dB(A)	51	54	54	61	61	61	62	61	65	65	
	Dimensions	H*W*D	mm	630-809-300	630-809-300	943-960-330(+30)	943-960-330(+30)	1338-1050-330(+40)	1338-1050-330(+40)	1338-1050-330(+40)	1338-1050-330(+40)	1338-1050-330(+40)	1338-1050-330(+40)	
Ext.Piping	Diameter ⁽⁵⁾	Liquid/Gas	mm	6.35 / 12.7	6.35 / 12.7	9.52 / 15.88	9.52 / 15.88	9.52 / 15.88	9.52 / 15.88	9.52 / 15.88	9.52 / 15.88	9.52 / 15.88	9.52 / 15.88	
	Max.Length	Out-In	m	50	50	50	50	75	75	75	75	75	75	
	Max.Height	Out-In	m	30	30	30	30	30	30	30	30	30	30	
	Guaranteed Operating Range (Outdoor)	Cooling ⁽³⁾	°C	-15 ~ +46	-15 ~ +46	-15 ~ +46	-15 ~ +46	-15 ~ +46	-15 ~ +46	-15 ~ +46	-15 ~ +46	-15 ~ +46	-15 ~ +46	
Heating	°C	-11 ~ +21	-11 ~ +21	-20 ~ +21	-20 ~ +21	-20 ~ +21	-20 ~ +21	-20 ~ +21	-20 ~ +21	-20 ~ +21	-20 ~ +21	-20 ~ +21		

*1 Refrigerant leakage contributes to climate change. Refrigerant with lower global warming potential (GWP) would contribute less to global warming than a refrigerant with higher GWP, if leaked to the atmosphere. This appliance contains a refrigerant fluid with a GWP equal to 1975. This means that if 1 kg of this refrigerant fluid would be leaked to the atmosphere, the impact on global warming would be 1975 times higher than 1 kg of CO₂ over a period of 100 years. Never try to interfere with the refrigerant circuit yourself or disassemble the product yourself and always ask a professional. The GWP of R410A is 2088 in the IPCC 4th Assessment Report.
 *2 Energy consumption based on standard test results. Actual energy consumption will depend on how the appliance is used and where it is located.
 *3 Optional air protection guide is required where ambient temperature is lower than -5°C. *4 SEER and SCOP are based on 2009/125/EC:Energy-related Products Directive and Regulation(EU) No206/2012.
 *5 Joint pipe is required depending on installed refrigerant pipes, outdoor units and indoor units.

PLA-M SERIES

STANDARD INVERTER



Type		Inverter Heat Pump												
Indoor Unit		PLA-M35EA2	PLA-M50EA2	PLA-M60EA2	PLA-M71EA2	PLA-M100EA2	PLA-M125EA2	PLA-M152EA2	PLA-M140EA2	PLA-M140EA2	PLA-M140EA2	PLA-M140EA2		
Outdoor Unit		SUZ-KA35VA6	SUZ-KA50VA6	SUZ-KA60VA6	SUZ-KA71VA6	PUHZ-P100VKA	PUHZ-P100VKA	PUHZ-P125VKA	PUHZ-P125VKA	PUHZ-P140VKA	PUHZ-P140VKA	PUHZ-P140VKA		
Refrigerant ⁽¹⁾		R410A												
Power Supply		Outdoor power supply VA-VKA:230/Single/50, YKA:400/Three/50												
Cooling	Capacity	Rated	kW	3.6	5.5	5.7	7.1	9.4	9.4	12.1	12.1	13.6	13.6	
		Min-Max	kW	1.4 - 3.9	2.3 - 5.6	2.3 - 6.3	2.8 - 8.1	3.7 - 10.6	3.7 - 10.6	5.6 - 13.0	5.6 - 13.0	5.8 - 14.1	5.8 - 14.1	
	Total Input	Rated	kW	1.020	1.610	1.760	2.100	3.186	3.186	4.101	4.101	5.418	5.418	
	EER	Rated		3.53	3.42	3.24	3.38	2.95	2.95	2.95	2.95	2.51	2.51	
Heating	Capacity	Rated	kW	4.1	5.8	6.9	8.0	11.2	11.2	13.5	13.5	15.0	15.0	
		Min-Max	kW	1.7 - 5.0	1.7 - 7.2	2.5 - 8.0	2.6 - 10.2	2.8 - 12.5	2.8 - 12.5	4.8 - 15.0	4.8 - 15.0	4.9 - 15.8	4.9 - 15.8	
	Total Input	Rated	kW	1.000	1.690	1.970	2.247	3.265	3.265	3.846	3.846	4.672	4.672	
	COP	Rated		4.10	3.43	3.50	3.56	3.43	3.43	3.51	3.51	3.21	3.21	
Energy efficiency class	Design load		kW	2.6	4.3	4.6	5.8	8.0	8.0	—	—	—	—	
	Declared Capacity	at reference design temperature	kW	2.3 (-10°C)	3.8 (-10°C)	4.0 (-10°C)	4.7 (-10°C)	6.0 (-10°C)	6.0 (-10°C)	—	—	—	—	
		at bivalent temperature	kW	2.3 (-7°C)	3.8 (-7°C)	4.1 (-7°C)	4.1 (-7°C)	7.0 (-7°C)	7.0 (-7°C)	—	—	—	—	
		at operation limit temperature	kW	2.3 (-10°C)	3.8 (-10°C)	4.0 (-10°C)	4.7 (-10°C)	4.5 (-15°C)	4.5 (-15°C)	—	—	—	—	
Energy efficiency class	Back up heating capacity		kW	0.3	0.5	0.6	1.1	2.0	2.0	—	—	—	—	
	Annual electricity consumption ⁽²⁾		kWh/a	826	1499	1493	1888	2433	2433	—	—	—	—	
	SCOP ⁽⁴⁾			4.4	4.0	4.3	4.3	4.6	4.6	—	—	—	—	
	Operating Current(Max)		A	8.4	12.2	14.2	16.4	20.5	20.5	12.0	27.2	12.2	30.7	12.2
Indoor Unit	Input [cooling / Heating]	Rated	kW	0.03 / 0.03	0.03 / 0.03	0.03 / 0.03	0.04 / 0.04	0.07 / 0.07	0.07 / 0.07	0.10 / 0.10	0.10 / 0.10	0.10 / 0.10	0.10 / 0.10	
	Operating Current(Max)		A	0.20	0.22	0.24	0.27	0.46	0.46	0.66	0.66	0.66	0.66	
	Dimensions	H*W*D	mm	258-840-840 <40-950-950>										
	Weight		kg	19 <5> 19 <5> 21 <5> 21 <5> 24 <5> 24 <5> 26 <5> 26 <5> 26 <5> 26 <5>										
Outdoor Unit	Air Volume (Lo-Mi2-Mi1-Hi)		m³/min	11-13-15-16	12-14-16-18	12-14-16-18	14-17-19-21	19-23-26-29	19-23-26-29	21-25-28-31	21-25-28-31	24-26-29-32	24-26-29-32	
	Sound Level (Lo-Mi2-Mi1-Hi) (SPL)		dB(A)	26-28-29-31	27-29-31-32	27-29-31-32	28-30-32-34	31-34-37-40	31-34-37-40	33-37-41-44	33-37-41-44	36-39-42-44	36-39-42-44	
	Sound Level (PWL)		dB(A)	51	54	54	56	61	61	65	65	65	65	
	Dimensions	H*W*D	mm	550-800-285	880-840-330	880-840-330	880-840-330	981-1050-330	981-1050-330	981-1050-330	981-1050-330	981-1050-330	981-1050-330	
Ext.Piping	Diameter ⁽⁵⁾	Liquid/Gas	mm	6.35 / 9.52	6.35 / 12.7	6.35 / 15.88	9.52 / 15.88	9.52 / 15.88	9.52 / 15.88	9.52 / 15.88	9.52 / 15.88	9.52 / 15.88	9.52 / 15.88	
	Max.Length	Out-In	m	20	30	30	30	50	50	50	50	50	50	
	Max.Height	Out-In	m	12	30	30	30	30	30	30	30	30	30	
	Guaranteed Operating Range (Outdoor)	Cooling ⁽³⁾	°C	-10 ~ +46	-15 ~ +46	-15 ~ +46	-15 ~ +46	-15 ~ +46	-15 ~ +46	-15 ~ +46	-15 ~ +46	-15 ~ +46	-15 ~ +46	
Heating	°C	-10 ~ +24	-10 ~ +24	-10 ~ +24	-10 ~ +24	-15 ~ +21	-15 ~ +21	-15 ~ +21	-15 ~ +21	-15 ~ +21	-15 ~ +21	-15 ~ +21		

*1 Refrigerant leakage contributes to climate change. Refrigerant with lower global warming potential (GWP) would contribute less to global warming than a refrigerant with higher GWP, if leaked to the atmosphere. This appliance contains a refrigerant fluid with a GWP equal to 1975. This means that if 1 kg of this refrigerant fluid would be leaked to the atmosphere, the impact on global warming would be 1975 times higher than 1 kg of CO₂ over a period of 100 years. Never try to interfere with the refrigerant circuit yourself or disassemble the product yourself and always ask a professional. The GWP of R410A is 2088 in the IPCC 4th Assessment Report.
 *2 Energy consumption based on standard test results. Actual energy consumption will depend on how the appliance is used and where it is located.
 *3 Optional air protection guide is required where ambient temperature is lower than -5°C. *4 SEER and SCOP are based on 2009/125/EC:Energy-related Products Directive and Regulation(EU) No206/2012.
 *5 Joint pipe is required depending on installed refrigerant pipes, outdoor units and indoor units.

PLA-M SERIES

POWER INVERTER



Type		Inverter Heat Pump												
Indoor Unit		PLA-M35EA2	PLA-M50EA2	PLA-M60EA2	PLA-M71EA2	PLA-M100EA2	PLA-M100EA2	PLA-M125EA2	PLA-M125EA2	PLA-M140EA2	PLA-M140EA2	PLA-M140EA2		
Outdoor Unit		PUHZ-ZRP35VKA2	PUHZ-ZRP50VKA2	PUHZ-ZRP60VHA2	PUHZ-ZRP71VHA2	PUHZ-ZRP100VKA3	PUHZ-ZRP100YKA3	PUHZ-ZRP125VKA3	PUHZ-ZRP125YKA3	PUHZ-ZRP140VKA3	PUHZ-ZRP140YKA3	PUHZ-ZRP140YKA3		
Refrigerant ^(*)		R410A												
Power Supply		Outdoor power supply												
Source		VKA-VHA:230/Single/50, YKA:400/Three/50												
Outdoor(V/Phase/Hz)														
Cooling	Capacity	Rated	kW	3.6	5.0	6.1	7.1	9.5	9.5	12.5	12.5	13.4	13.4	
		Min-Max	kW	1.6 - 4.5	2.3 - 5.6	2.7 - 6.5	3.3 - 8.1	4.9 - 11.4	4.9 - 11.4	5.5 - 14.0	5.5 - 14.0	6.2 - 15.0	6.2 - 15.0	
	Total Input	Rated	kW	0.833	1.416	1.747	1.868	2.230	2.230	3.869	3.869	4.393	4.393	
	EER			4.32	3.53	3.49	3.80	4.26	4.26	3.23	3.23	3.05	3.05	
	Design load		kW	3.6	5.0	6.1	7.1	9.5	9.5	—	—	—	—	
	Annual electricity consumption ^(**)		kWh/a	174	258	321	341	465	475	—	—	—	—	
SEER			7.2	6.7	6.6	7.2	7.1	6.9	—	—	—	—		
	Energy efficiency class		A++	A++	A++	A++	A++	A++	—	—	—	—		
Heating (Average Season)	Capacity	Rated	kW	4.1	6.0	7.0	8.0	11.2	11.2	14.0	14.0	16.0	16.0	
		Min-Max	kW	1.6 - 5.8	2.5 - 7.3	2.8 - 8.2	3.5 - 10.2	4.5 - 14.0	4.5 - 14.0	5.0 - 16.0	5.0 - 16.0	5.7 - 18.0	5.7 - 18.0	
	Total Input	Rated	kW	0.920	1.810	2.070	2.110	2.690	2.690	3.773	3.773	4.907	4.907	
	COP			4.46	3.31	3.38	3.79	4.16	4.16	3.71	3.71	3.26	3.26	
	Design load		kW	2.5	3.8	4.4	4.7	7.8	7.8	—	—	—	—	
	Declared Capacity	at reference design temperature	kW	2.5 (-10°C)	3.8 (-10°C)	4.4 (-10°C)	4.7 (-10°C)	7.8 (-10°C)	7.8 (-10°C)	—	—	—	—	
		at bivalent temperature	kW	2.5 (-10°C)	3.8 (-10°C)	4.4 (-10°C)	4.7 (-10°C)	7.8 (-10°C)	7.8 (-10°C)	—	—	—	—	
		at operation limit temperature	kW	2.1 (-11°C)	3.7 (-11°C)	2.8 (-11°C)	3.5 (-11°C)	5.8 (-20°C)	5.8 (-20°C)	—	—	—	—	
	Back up heating capacity		kW	0.0	0.0	0.0	0.0	0.0	0.0	—	—	—	—	
	Annual electricity consumption ^(**)		kWh/a	766	1215	1421	1405	2471	2472	—	—	—	—	
SCOP			4.5	4.3	4.3	4.6	4.4	4.4	—	—	—	—		
	Energy efficiency class		A+	A+	A+	A++	A+	A+	—	—	—	—		
Operating Current(Max)		A	13.2	13.2	19.2	19.3	27.0	8.5	27.2	10.2	28.7	13.7		
Indoor Unit	Input [cooling / Heating]	Rated	kW	0.03 / 0.03	0.03 / 0.03	0.03 / 0.03	0.04 / 0.04	0.07 / 0.07	0.07 / 0.07	0.10 / 0.10	0.10 / 0.10	0.10 / 0.10	0.10 / 0.10	
	Operating Current(Max)		A	0.20	0.22	0.24	0.27	0.46	0.46	0.66	0.66	0.66	0.66	
	Dimensions	H*W*D	mm	258-840-840 <40-950-950>			24 <5>			298-840-840 <40-950-950>			26 <5>	
	Weight		kg	19 <5>	19 <5>	21 <5>	21 <5>	24 <5>	24 <5>	26 <5>	26 <5>	26 <5>	26 <5>	
	Air Volume (Lo-Mid-Hi)		m ³ /min	11-13-15-16	12-14-16-18	12-14-16-18	14-17-19-21	19-23-26-29	19-23-26-29	21-25-28-31	21-25-28-31	24-26-29-32	24-26-29-32	
	External Static Pressure		Pa	0	0	0	0	0	0	0	0	0	0	
	Sound Level (Lo-Mid-Hi) (SPL)		dB(A)	26-28-29-31	27-29-31-32	27-29-31-32	28-30-32-34	31-34-37-40	31-34-37-40	33-37-41-44	33-37-41-44	36-39-42-44	36-39-42-44	
	Sound Level (PWL)		dB(A)	51	54	54	56	61	61	65	65	65	65	
	Dimensions	H*W*D	mm	630-809-300	630-809-300	943-950-330(+30)	943-950-330(+30)	1338-1050-330(+40)	1338-1050-330(+40)	1338-1050-330(+40)	1338-1050-330(+40)	1338-1050-330(+40)	1338-1050-330(+40)	
	Outdoor Unit	Weight		kg	43	46	70	70	116	123	116	125	118	131
Air Volume		Cooling	m ³ /min	45	45	55	55	110	110	120	120	120	120	
		Heating	m ³ /min	45	45	55	55	110	110	120	120	120	120	
Sound Level (SPL)		Cooling	dB(A)	44	44	47	47	49	49	50	50	50	50	
		Heating	dB(A)	46	46	48	48	51	51	52	52	52	52	
Sound Level (PWL)		Cooling	dB(A)	65	65	67	67	69	69	70	70	70	70	
		Heating	dB(A)	65	65	67	67	69	69	70	70	70	70	
Operating Current(Max)		A	13	13	19	19	26.5	8	26.5	9.5	28	13		
Breaker Size		A	16	16	25	25	32	16	32	16	40	16		
Ext.Piping	Diameter ^(**)	Liquid/Gas	mm	6.35 / 12.7	6.35 / 12.7	9.52 / 15.88	9.52 / 15.88	9.52 / 15.88	9.52 / 15.88	9.52 / 15.88	9.52 / 15.88	9.52 / 15.88	9.52 / 15.88	
	Max.Length	Out-In	m	50	50	50	50	75	75	75	75	75		
	Max.Height	Out-In	m	30	30	30	30	30	30	30	30	30		
Guaranteed Operating Range (Outdoor)	Cooling ^(**)	°C	-15 ~ +46	-15 ~ +46	-15 ~ +46	-15 ~ +46	-15 ~ +46	-15 ~ +46	-15 ~ +46	-15 ~ +46	-15 ~ +46	-15 ~ +46		
	Heating	°C	-11 ~ +21	-11 ~ +21	-11 ~ +21	-20 ~ +21	-20 ~ +21	-20 ~ +21	-20 ~ +21	-20 ~ +21	-20 ~ +21	-20 ~ +21		

*1 Refrigerant leakage contributes to climate change. Refrigerant with lower global warming potential (GWP) would contribute less to global warming than a refrigerant with higher GWP, if leaked to the atmosphere. This appliance contains a refrigerant fluid with a GWP equal to 1975. This means that if 1 kg of this refrigerant fluid would be leaked to the atmosphere, the impact on global warming would be 1975 times higher than 1 kg of CO₂ over a period of 100 years. Never try to interfere with the refrigerant circuit yourself or disassemble the product yourself and always ask a professional. The GWP of R410A is 2088 in the IPCC 4th Assessment Report.

*2 Energy consumption based on standard test results. Actual energy consumption will depend on how the appliance is used and where it is located.

*3 Optional air protection guide is required where ambient temperature is lower than -5°C.

*4 SEER and SCOP are based on 2009/125/EC:Energy-related Products Directive and Regulation(EU) No206/2012.

*5 Joint pipe is required depending on installed refrigerant pipes, outdoor units and indoor units.

PEAD SERIES

R32
R410A



PEAD-M35/50/60/71/100/125/140JA2



Energy efficiency has been improved. A reduced electricity consumption contributes to a further reduction in operating cost. The thin body with a wide-ranged external static pressure of this series is the perfect answer for the air conditioning needs of buildings with minimum ceiling installation space.

ErP Lot-10 compliant, Achieving High Energy Efficiency



The shape of fan wing and casing is improved to provide more smooth air flow, increasing the operation efficiency. All models under 12kW(M35~M100) are complied with ErP Lot 10 and energy rankings of A++ for cooling and A+ for heating. This contributes to a reduction in the cost of annual electricity.

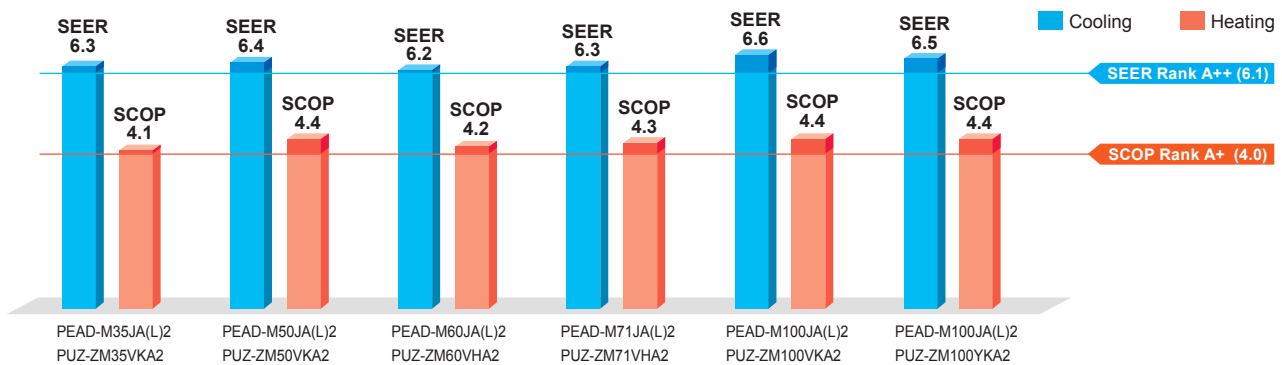

Compact Indoor Units

The height of the models from 35-140 has been unified to 250 mm, which makes installation in low ceiling with minimal clearance space possible.

Selectable Static Pressure Levels

External static pressure conversion can be set up to five levels. Capable of being set to a maximum of 150 Pa, units are applicable to a wide range of building types.

Drain Pump is Optionally Selectable

The line-up consists of two types: models with or without a built-in drain pump, thus allowing more freedom in piping design.

- PEAD-M JA2 ▶ Built-in drain pump
- PEAD-M JAL2 ▶ No drain pump

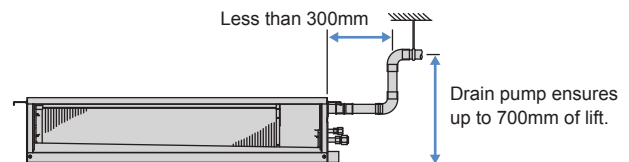

Connectable to Plasma Quad Connect

The optional Plasma Quad Connect MAC-100FT-E can be installed on the indoor unit's air inlet side. For installation, PQ attachment or PQ box is required.

SERIES SELECTION

Power Inverter Series



Indoor Unit

R32
R410A



PEAD-M35/50/60/71/100/125/140JA(L)2

Outdoor Unit

R32

For Single



PUZ-ZM35/50 PUZ-ZM60/71 PUZ-ZM100/125/140

R32

For Multi
(Twin/Triple/Quadruple)



PUZ-ZM71 PUZ-ZM100/125/140/200/250

Remote Controller



Optional Optional Optional Optional* Optional*

* PAR-SA9CA-E is also required.

PEAD-M JA(L)2 Indoor Unit Combinations Indoor unit combinations shown below are possible.

Indoor Unit Combination	Outdoor Unit Capacity																			
	For Single								For Twin				For Triple			For Quadruple				
	35	50	60	71	100	125	140	200	250	71	100	125	140	200	250	140	200	250	200	250
Power Inverter (PUZ-ZM)	35x1	50x1	60x1	71x1	100x1	125x1	140x1	-	-	35x2	50x2	60x2	71x2	100x2	125x2	50x3	60x3	71x3	50x4	60x4
Distribution Pipe	-	-	-	-	-	-	-	-	-	MSDD-50TR2-E				MSDD-50WR2-E		MSDT-111R3-E			MSDF-1111R2-E	

SERIES SELECTION

Standard Inverter Series



Indoor Unit

R32
R410A



PEAD-M35/50/60/71/100/125/140JA(L)2

Outdoor Unit

R32

For Single



SUZ-M35 SUZ-M50 SUZ-M60/71 PUZ-M100/125/140

R32

For Multi
(Twin/Triple/Quadruple)



PUZ-M100/125/140 PUZ-M200/250

Remote Controller



Optional Optional Optional Optional* Optional*

* PAR-SA9CA-E is also required.

PEAD-M JA(L)2 Indoor Unit Combinations Indoor unit combinations shown below are possible.

Indoor Unit Combination	Outdoor Unit Capacity																			
	For Single								For Twin				For Triple			For Quadruple				
	35	50	60	71	100	125	140	200	250	71	100	125	140	200	250	140	200	250	200	250
Standard Inverter (PUZ-M&SUZ)	35x1	50x1	60x1	71x1	100x1	125x1	140x1	-	-	-	50x2	60x2	71x2	100x2	125x2	50x3	60x3	71x3	50x4	60x4
Distribution Pipe	-	-	-	-	-	-	-	-	-	MSDD-50TR2-E				MSDD-50WR2-E		MSDT-111R3-E			MSDF-1111R2-E	

PEAD-M SERIES

POWER INVERTER

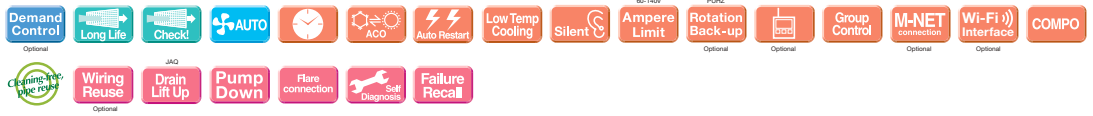

Type		Inverter Heat Pump											
Indoor Unit		PEAD-M35JAIL2	PEAD-M50JAIL2	PEAD-M60JAIL2	PEAD-M71JAIL2	PEAD-M100JAIL2	PEAD-M100JAIL2	PEAD-M125JAIL2	PEAD-M125JAIL2	PEAD-M140JAIL2	PEAD-M140JAIL2	PEAD-M140JAIL2	
Outdoor Unit		PUZ-ZM35VK2	PUZ-ZM50VK2	PUZ-ZM60VHA2	PUZ-ZM71VHA2	PUZ-ZM100VK2	PUZ-ZM100VK2	PUZ-ZM125VK2	PUZ-ZM125VK2	PUZ-ZM140VK2	PUZ-ZM140VK2	PUZ-ZM140VK2	
Refrigerant ^(*)		R32											
Power Supply		Outdoor power supply VA-VKA:230/Single/50, YKA:400/Three/50											
Cooling	Capacity	Rated	kW	3.6	5.0	6.1	7.1	9.5	9.5	12.5	12.5	13.4	13.4
		Min-Max	kW	1.6 - 4.5	2.3 - 5.6	2.7 - 6.7	3.3 - 8.1	4.9 - 11.4	4.9 - 11.4	5.5 - 14.0	5.5 - 14.0	6.2 - 15.3	6.2 - 15.3
	Total Input	Rated	kW	0.837	1.190	1.487	1.775	2.261	2.261	3.333	3.333	3.701	3.701
	EER ⁽⁴⁾	Rated		4.30	4.20	4.10	4.00	4.20	4.20	3.75	3.75	3.62	3.62
	Design load		kW	3.6	5.0	6.1	7.1	9.5	9.5	-	-	-	-
Heating	Capacity	Rated	kW	4.1	6.0	7.0	8.0	11.2	11.2	14.0	14.0	16.0	16.0
		Min-Max	kW	1.6 - 5.2	2.5 - 7.3	2.8 - 8.2	3.5 - 10.2	4.5 - 14.0	4.5 - 14.0	5.0 - 16.0	5.0 - 16.0	5.7 - 18.0	5.7 - 18.0
	Total Input	Rated	kW	0.911	1.363	1.590	1.904	2.545	2.545	3.763	3.763	4.102	4.102
	COP ⁽⁴⁾	Rated		4.50	4.40	4.40	4.20	4.40	4.40	3.72	3.72	3.90	3.90
	Design load		kW	2.4	3.8	4.4	4.9	7.8	7.8	-	-	-	-
Operating Current(Max)	Input [cooling / Heating]	Rated	kW	0.05	0.07	0.08	0.09	0.14	0.14	0.20	0.20	0.21	0.21
	Operating Current(Max)		A	1.16	1.35	1.85	1.99	2.25	2.25	2.34	2.34	2.63	2.63
	Dimensions	H*W*D	mm	250x900x732	250x900x732	250x1100x732	250x1100x732	250x1400x732	250x1400x732	250x1400x732	250x1600x732	250x1600x732	250x1600x732
	Weight		kg	25(24.5)	26.5(25.5)	29.5(29)	29.5(29)	37(36)	37(36)	38(37)	38(37)	42(41)	42(41)
	Air Volume (Lo-Mid-Hi)		m ³ /min	10.0-12.0-14.0	12.0-14.5-17.0	14.5-18.0-21.0	14.5-18.0-23.0	23.0-28.0-32.0	23.0-28.0-32.0	28.0-34.0-37.0	28.0-34.0-37.0	29.5-35.5-40.0	29.5-35.5-40.0
Outdoor Unit	External Static Pressure ⁽⁷⁾		Pa	35-<50>-<70>-<100>-<150>	35-<50>-<70>-<100>-<150>	40-<50>-<70>-<100>-<150>	40-<50>-<70>-<100>-<150>	40-<50>-<70>-<100>-<150>	40-<50>-<70>-<100>-<150>	40-<50>-<70>-<100>-<150>	40-<50>-<70>-<100>-<150>	40-<50>-<70>-<100>-<150>	
	Sound Level (Lo-Mid-Hi) (SPL)		dB(A)	24-29-32	27-33-35	26-32-35	26-32-37	31-36-39	31-36-39	35-39-41	35-39-41	34-38-41	34-38-41
	Sound Level (PWL)		dB(A)	54	58	56	58	62	62	66	66	66	66
	Dimensions (PWL)	H*W*D	mm	630-809-300	630-809-300	943-950-330(+25)	943-950-330(+25)	1338-1050-330(+40)	1338-1050-330(+40)	1338-1050-330(+40)	1338-1050-330(+40)	1338-1050-330(+40)	1338-1050-330(+40)
	Weight		kg	46	46	67	67	105	105	111	105	118	118
Ext.Piping	Air Volume	Cooling	m ³ /min	45	45	55	55	110	110	120	120	120	120
		Heating	m ³ /min	45	45	55	55	110	110	120	120	120	120
	Sound Level (SPL)	Cooling	dB(A)	44	44	47	47	49	49	50	50	50	50
		Heating	dB(A)	46	46	49	49	51	51	52	52	52	52
	Sound Level (PWL)	Cooling	dB(A)	65	65	67	67	69	69	70	70	70	70
Guaranteed Operating Range (Outdoor)	Operating Current(Max)		A	13	13	19	19	20	8	26.5	9	30	11.8
	Breaker Size		A	16	16	25	25	32	16	32	16	40	16
	Diameter ⁽⁶⁾	Liquid/Gas	mm	6.35 / 12.7	6.35 / 12.7	9.52 / 15.88	9.52 / 15.88	9.52 / 15.88	9.52 / 15.88	9.52 / 15.88	9.52 / 15.88	9.52 / 15.88	9.52 / 15.88
Guaranteed Operating Range (Outdoor)	Max.Length	Out-In	m	50	50	55	55	100	100	100	100	100	
	Max.Height	Out-In	m	30	30	30	30	30	30	30	30	30	
	Cooling ⁽³⁾		°C	-15 ~ +46	-15 ~ +46	-15 ~ +46	-15 ~ +46	-15 ~ +46	-15 ~ +46	-15 ~ +46	-15 ~ +46	-15 ~ +46	
	Heating		°C	-11 ~ +21	-11 ~ +21	-20 ~ +21	-20 ~ +21	-20 ~ +21	-20 ~ +21	-20 ~ +21	-20 ~ +21	-20 ~ +21	

*1 Refrigerant leakage contributes to climate change. Refrigerant with lower global warming potential (GWP) would contribute less to global warming than a refrigerant with higher GWP if leaked to the atmosphere. This appliance contains a refrigerant fluid with a GWP equal to 550. This means that if 1 kg of this refrigerant fluid would be leaked to the atmosphere, the impact on global warming would be 550 times higher than 1 kg of CO₂ over a period of 100 years. Never try to interfere with the refrigerant circuit yourself or disassemble the product yourself and always ask a professional. The GWP of R32 is 675 in the IPCC 4th Assessment Report.
 *2 Energy consumption based on standard test results. Actual energy consumption will depend on how the appliance is used and where it is located.
 *3 Optional air protection guide is required where ambient temperature is lower than -5°C. *4 EER/COP and SEER/SCOP for M35-71 are measured at ESP 35Pa, for M100 at ESP 37Pa, for M125/140 at ESP 50Pa.
 *5 SEER and SCOP are based on 2009/125/EC/Energy-related Products Directive and Regulation(EU) No206/2012. *6 Joint pipe is required depending on installed refrigerant pipes, outdoor units and indoor units.
 *7 The factory setting of ESP is shown without < > .

PEAD-M SERIES

STANDARD INVERTER

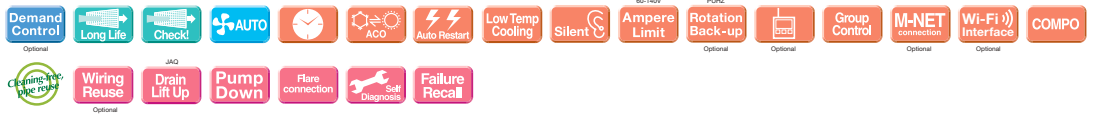

Type		Inverter Heat Pump											
Indoor Unit		PEAD-M35JAIL2	PEAD-M50JAIL2	PEAD-M60JAIL2	PEAD-M71JAIL2	PEAD-M100JAIL2	PEAD-M100JAIL2	PEAD-M125JAIL2	PEAD-M125JAIL2	PEAD-M140JAIL2	PEAD-M140JAIL2	PEAD-M140JAIL2	
Outdoor Unit		SUZ-M35VA	SUZ-M50VA	SUZ-M60VA	SUZ-M71VA	PUZ-M100VK2	PUZ-M100VK2	PUZ-M125VK2	PUZ-M125VK2	PUZ-M140VK2	PUZ-M140VK2	PUZ-M140VK2	
Refrigerant ^(*)		R32											
Power Supply		Outdoor power supply VA-VKA:230/Single/50, YKA:400/Three/50											
Cooling	Capacity	Rated	kW	3.6	5.0	6.1	7.1	9.5	9.5	12.1	12.1	13.4	13.4
		Min-Max	kW	0.8 - 3.9	1.7 - 5.6	1.6 - 6.3	2.2 - 8.1	4.0 - 10.6	4.0 - 10.6	6.0 - 13.0	6.0 - 13.0	6.1 - 14.1	6.1 - 14.1
	Total Input	Rated	kW	0.923	1.351	1.694	2.028	2.878	2.878	4.019	4.019	4.768	4.768
	EER ⁽⁴⁾	Rated		3.90	3.70	3.60	3.50	3.30	3.30	3.01	3.01	2.81	2.81
	Design load		kW	3.6	5.0	6.1	7.1	9.5	9.5	-	-	-	-
Heating	Capacity	Rated	kW	4.1	6.0	7.0	8.0	11.2	11.2	13.5	13.5	15.0	15.0
		Min-Max	kW	1.1 - 5.0	1.5 - 7.2	1.6 - 8.0	2.0 - 10.2	2.8 - 12.5	2.8 - 12.5	4.1 - 15.0	4.1 - 15.0	4.2 - 15.8	4.2 - 15.8
	Total Input	Rated	kW	1.025	1.463	1.842	2.105	2.947	2.947	4.159	4.159	4.768	4.768
	COP ⁽⁴⁾	Rated		4.00	4.10	3.80	3.80	3.80	3.80	3.61	3.61	3.61	3.61
	Design load		kW	2.6	4.3	4.6	5.8	8.0	8.0	-	-	-	-
Operating Current(Max)	Capacity	at reference design temperature	kW	2.3 (-10°C)	3.8 (-10°C)	4.1 (-10°C)	5.2 (-10°C)	6.0 (-10°C)	6.0 (-10°C)	-	-	-	-
		at bivalent temperature	kW	2.3 (-7°C)	3.8 (-7°C)	4.1 (-7°C)	5.2 (-7°C)	6.0 (-7°C)	7.0 (-7°C)	7.0 (-7°C)	-	-	-
		at operation limit temperature	kW	2.3 (-10°C)	3.8 (-10°C)	4.1 (-10°C)	5.2 (-10°C)	6.0 (-10°C)	7.0 (-10°C)	7.0 (-10°C)	-	-	-
	Back up heating capacity		kW	0.3	0.5	0.5	0.6	2.0	2.0	-	-	-	-
	Annual electricity consumption ⁽²⁾		kWh/a	884	1417	1558	1973	2725	2725	-	-	-	-
Outdoor Unit	External Static Pressure ⁽⁷⁾		Pa	24-29-32	27-33-35	26-32-35	26-32-37	31-36-39	31-36-39	35-39-41	35-39-41	34-38-41	34-38-41
	Sound Level (Lo-Mid-Hi) (SPL)		dB(A)	54	58	56	58	62	62	66	66	66	66
	Sound Level (PWL)		dB(A)	54	58	56	58	62	62	66	66	66	66
	Dimensions (PWL)	H*W*D	mm	550-800-285	714-800-285	880-840-330	880-840-330	981-1050-330(+40)	981-1050-330(+40)	981-1050-330(+40)	981-1050-330(+40)	981-1050-330(+40)	981-1050-330(+40)
	Weight		kg	35	41	54	55	76	78	84	85	84	85
Ext.Piping	Air Volume	Cooling	m ³ /min	34.3	45.8	50.1	50.1	79	79	86	86	86	86
		Heating	m ³ /min	32.7	43.7	50.1	50.1	79	79	92	92	92	92
	Sound Level (SPL)	Cooling	dB(A)	48	48	49	49	51	51	54	54	55	55
		Heating	dB(A)	48	49	51	51	54	54	56	56	57	57
	Sound Level (PWL)	Cooling	dB(A)	59	64	65	66	70	70	72	72	73	73
Guaranteed Operating Range (Outdoor)	Operating Current(Max)		A	8.5	13.5	14.8	14.8	20	11.5	26.5	11.5	30	11.5
	Breaker Size		A	16	20	20	20	32	16	32	16	40	16
	Diameter ⁽⁶⁾	Liquid/Gas	mm	6.35 / 9.52	6.35 / 12.7	6.35 / 15.88	9.52 / 15.88	9.52 / 15.88	9.52 / 15.88	9.52 / 15.88	9.52 / 15.88	9.52 / 15.88	9.52 / 15.88
Guaranteed Operating Range (Outdoor)	Max.Length	Out-In	m	20	30	30	30	55	55	65	65	65	
	Max.Height	Out-In	m	12	30	30	30	30	30	30	30	30	
	Cooling ⁽³⁾		°C	-10 ~ +46	-15 ~ +46	-15 ~ +46	-15 ~ +46	-15 ~ +46	-15 ~ +46	-15 ~ +46	-15 ~ +46	-15 ~ +46	
	Heating		°C	-10 ~ +24	-10 ~ +24	-10 ~ +24	-10 ~ +24	-15 ~ +21	-15 ~ +21	-15 ~ +21	-15 ~ +21	-15 ~ +21	

*1 Refrigerant leakage contributes to climate change. Refrigerant with lower global warming potential (GWP) would contribute less to global warming than a refrigerant with higher GWP if leaked to the atmosphere. This appliance contains a refrigerant fluid with a GWP equal to 550. This means that if 1 kg of this refrigerant fluid would be leaked to the atmosphere, the impact on global warming would be 550 times higher than 1 kg of CO₂ over a period of 100 years. Never try to interfere with the refrigerant circuit yourself or disassemble the product yourself and always ask a professional. The GWP of R32 is 675 in the IPCC 4th Assessment Report.
 *2 Energy consumption based on standard test results. Actual energy consumption will depend on how the appliance is used and where it is located.
 *3 Optional air protection guide is required where ambient temperature is lower than -5°C. *4 EER/COP and SEER/SCOP for M35-71 are measured at ESP 35Pa, for M100 at ESP 37Pa, for M125/140 at ESP 50Pa.
 *5 SEER and SCOP are based on 2009/125/EC/Energy-related Products Directive and Regulation(EU) No206/2012. *6 Joint pipe is required depending on installed refrigerant pipes, outdoor units and indoor units.
 *7 The factory setting of ESP is shown without < > .

SERIES SELECTION

Power Inverter Series



Indoor Unit

R32
R410A



PEAD-M35/50/60/71/100/125/140JA(L)2

Outdoor Unit

R410A

For Single



PUHZ-ZRP35/50



PUHZ-ZRP60/71



PUHZ-ZRP100/125/140

R410A

For Multi
(Twin/Triple/Quadruple)



PUHZ-ZRP71



PUHZ-ZRP100/125/140/200/250

Remote Controller



Optional



Optional



Optional



Optional*



Optional*

* PAR-SA9CA-E is also required.

PEAD-M JA(L) Indoor Unit Combinations Indoor unit combinations shown below are possible.

Indoor Unit Combination	Outdoor Unit Capacity																			
	For Single									For Twin					For Triple			For Quadruple		
	35	50	60	71	100	125	140	200	250	71	100	125	140	200	250	140	200	250	200	250
Power Inverter (PUHZ-ZRP)	35x1	50x1	60x1	71x1	100x1	125x1	140x1	-	-	35x2	50x2	60x2	71x2	100x2	125x2	50x3	60x3	71x3	50x4	60x4
Distribution Pipe	-	-	-	-	-	-	-	-	-	MSDD-50TR-E			MSDD-50WR-E		MSDT-111R-E			MSDF-1111R-E		

SERIES SELECTION

Standard Inverter Series



Indoor Unit

R32
R410A



PEAD-M35/50/60/71/100/125/140JA(L)2

Outdoor Unit

R410A

For Single



SUZ-KA35



SUZ-KA50/60/71



PUHZ-P100/125/140

R410A

For Multi
(Twin/Triple/Quadruple)



PUHZ-P100/125/140



PUHZ-P200/250

Remote Controller



Optional



Optional



Optional



Optional*



Optional*

* PAR-SA9CA-E is also required.

PEAD-M JA(L) Indoor Unit Combinations Indoor unit combinations shown below are possible.

Indoor Unit Combination	Outdoor Unit Capacity																			
	For Single									For Twin					For Triple			For Quadruple		
	35	50	60	71	100	125	140	200	250	71	100	125	140	200	250	140	200	250	200	250
Standard Inverter (PUHZ-P&SUZ)	35x1	50x1	60x1	71x1	100x1	125x1	140x1	-	-	50x2	60x2	71x2	100x2	125x2	50x3	60x3	71x3	50x4	60x4	
Distribution Pipe	-	-	-	-	-	-	-	-	-	MSDD-50TR-E			MSDD-50WR-E		MSDT-111R-E			MSDF-1111R-E		

PEAD-M SERIES

POWER INVERTER

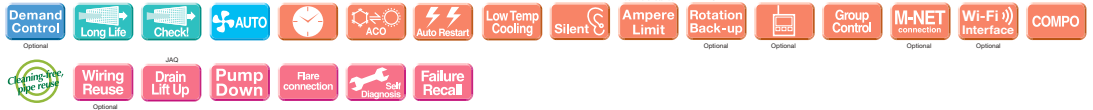

Type	Inverter Heat Pump												
Indoor Unit	PEAD-M35JAII2	PEAD-M50JAII2	PEAD-M60JAII2	PEAD-M71JAII2	PEAD-M100JAII2	PEAD-M100YKA3	PEAD-M125JAII2	PEAD-M125JAII2	PEAD-M140JAII2	PEAD-M140JAII2	PEAD-M140YKA3		
Outdoor Unit	PUHZ-RP35VKA2	PUHZ-RP50VKA2	PUHZ-RP60VHA2	PUHZ-RP71VHA2	PUHZ-RP100VKA3	PUHZ-RP100YKA3	PUHZ-RP125VKA3	PUHZ-RP125VKA3	PUHZ-RP140VKA3	PUHZ-RP140VKA3	PUHZ-RP140YKA3		
Refrigerant ⁽¹⁾	R410A												
Power Supply	Outdoor power supply VKA-VHA:230/Single/50, YKA:400/Three/50												
Cooling	Capacity	Rated	kW	3.6	5.0	6.1	7.1	9.5	9.5	12.5	12.5	13.4	13.4
	Total Input	Min-Max	kW	1.6 - 4.5	2.3 - 5.6	2.7 - 6.7	3.3 - 8.1	4.9 - 11.4	4.9 - 11.4	5.5 - 14.0	5.5 - 14.0	6.2 - 15.3	6.2 - 15.3
		Rated	kW	0.970	1.420	1.630	1.990	2.410	2.430	3.834	3.834	4.322	4.322
	EER ⁽⁴⁾	Rated		4.14	3.52	3.74	3.53 (3.57)	3.94	3.94	3.26	3.26	3.10	3.10
		Design load	kW	3.6	5.0	6.1	7.1	9.5	9.5	-	-	-	-
	Annual electricity consumption ⁽²⁾	kWh/a		205	287	340	411	542	553	-	-	-	-
SEER ⁽⁴⁾⁽¹⁵⁾			6.1	6.1	6.2	6.0	6.1	6.0	-	-	-	-	
Heating	Energy efficiency class			A++	A++	A++	A+	A+	A+	-	-	-	-
	Capacity	Rated	kW	4.1	6.0	7.0	8.0	11.2	11.2	14.0	14.0	16.0	16.0
		Min-Max	kW	1.6 - 5.2	2.5 - 7.3	2.8 - 8.2	3.5 - 10.2	4.5 - 14.0	4.5 - 14.0	5.0 - 16.0	5.0 - 16.0	5.7 - 18.0	5.7 - 18.0
	Total Input	Rated	kW	0.950	1.500	1.790	2.030	2.600	2.600	3.508	3.508	4.071	4.071
		COP ⁽⁴⁾		4.32	4.00	3.91	3.94	4.31	4.31	3.70 (3.99)	3.70 (3.99)	3.60	3.60
	Design load	kW		2.4	3.8	4.4	4.9	7.8	7.8	-	-	-	-
		Declared Capacity	at reference design temperature	kW	2.4 (-10°C)	3.8 (-10°C)	4.4 (-10°C)	4.9 (-10°C)	7.8 (-10°C)	7.8 (-10°C)	-	-	-
		at bivalent temperature	kW	2.4 (-10°C)	3.8 (-10°C)	4.4 (-10°C)	4.9 (-10°C)	7.8 (-10°C)	7.8 (-10°C)	-	-	-	-
		at operation limit temperature	kW	2.2 (-11°C)	3.7 (-11°C)	2.8 (-20°C)	3.7 (-20°C)	5.8 (-20°C)	5.8 (-20°C)	-	-	-	-
	Back up heating capacity	kW		0.0	0.0	0.0	0.0	0.0	0.0	-	-	-	-
Annual electricity consumption ⁽²⁾		kWh/a		831	1232	1487	1718	2593	2594	-	-	-	-
SCOP ⁽⁴⁾⁽¹⁵⁾			4.0	4.3	4.1	3.9	4.2	4.2	-	-	-	-	
Energy efficiency class			A+	A+	A+	A	A+	A+	-	-	-	-	
Operating Current(Max)	A		14.2	14.4	20.9	20.9	28.8	10.3	28.8	11.8	30.6	15.6	
Indoor Unit	Input (cooling / Heating)	Rated	kW	0.05	0.07	0.08	0.09	0.14	0.14	0.20	0.20	0.21	0.21
Outdoor Unit	Operating Current(Max)	A		1.16	1.35	1.85	1.9	2.25	2.25	2.34	2.63	2.63	
	Dimensions	H*W*D	mm	250x900x732	250x900x732	250x1100x732	250x1100x732	250x1400x732	250x1400x732	250x1400x732	250x1600x732	250x1600x732	
	Weight	kg		25(24.5)	26.5(25.5)	29.5(29)	29.5(29)	37(36)	37(36)	38(37)	42(41)	42(41)	
	Air Volume (Lo-Mid-Hi)	m³/min		10.0-12.0-14.0	12.0-14.5-17.0	14.5-18.0-21.0	14.5-18.0-23.0	23.0-28.0-32.0	23.0-28.0-32.0	28.0-34.0-37.0	28.0-34.0-37.0	29.5-35.5-40.0	
	External Static Pressure ⁽⁷⁾	Pa		35-<50-<70-<100-<150									
	Sound Level (Lo-Mid-Hi) (SPL)	dB(A)		24-29-32	27-33-35	26-32-35	26-32-37	31-36-39	31-36-39	35-39-41	35-39-41	34-38-41	
	Sound Level (PWL)	dB(A)		54	58	56	58	62	62	66	66	66	
	Dimensions	H*W*D	mm	630-890-300	630-890-300	943-950-330(+30)	943-950-330(+30)	1338-1050-330(+40)	1338-1050-330(+40)	1338-1050-330(+40)	1338-1050-330(+40)	1338-1050-330(+40)	
	Weight	kg		43	46	70	70	116	123	116	125	118	
	Air Volume	Cooling	m³/min		45	45	55	55	110	120	120	120	120
		Heating	m³/min		45	45	55	55	110	110	120	120	120
	Sound Level (SPL)	Cooling	dB(A)		44	44	47	47	49	49	50	50	50
		Heating	dB(A)		46	46	48	48	51	51	52	52	52
	Sound Level (PWL)	Cooling	dB(A)		65	65	67	67	69	69	70	70	70
Heating		dB(A)		63	63	65	65	68	68	70	70	70	
Operating Current(Max)	A		13	13	19	19	26.5	8	26.5	9.5	28	13	
Breaker Size	A		16	16	25	25	32	16	32	16	40	16	
Ext.Piping	Diameter ⁽⁶⁾	Liquid/Gas	mm	6.35 / 12.7	6.35 / 12.7	9.52 / 15.88	9.52 / 15.88	9.52 / 15.88	9.52 / 15.88	9.52 / 15.88	9.52 / 15.88	9.52 / 15.88	
Max.Length	Out-In	m		50	50	50	50	75	75	75	75		
Max.Height	Out-In	m		30	30	30	30	30	30	30	30		
Guaranteed Operating Range (Outdoor)	Cooling ⁽³⁾	°C		-15 ~ +46	-15 ~ +46	-15 ~ +46	-15 ~ +46	-15 ~ +46	-15 ~ +46	-15 ~ +46	-15 ~ +46	-15 ~ +46	
	Heating	°C		-11 ~ +21	-11 ~ +21	-20 ~ +21	-20 ~ +21	-20 ~ +21	-20 ~ +21	-20 ~ +21	-20 ~ +21	-20 ~ +21	

*1 Refrigerant leakage contributes to climate change. Refrigerant with lower global warming potential (GWP) would contribute less to global warming than a refrigerant with higher GWP if leaked to the atmosphere. This appliance contains a refrigerant fluid with a GWP equal to 1975. This means that if 1 kg of this refrigerant fluid would be leaked to the atmosphere, the impact on global warming would be 1975 times higher than 1 kg of CO₂ over a period of 100 years. Never try to interfere with the refrigerant circuit yourself or disassemble the product yourself and always ask a professional. The GWP of R410A is 2088 in the IPCC 4th Assessment Report.
 *2 Energy consumption based on standard test results. Actual energy consumption will depend on how the appliance is used and where it is located.
 *3 Optional air protection guide is required where ambient temperature is lower than -5°C. *4 EER/COP and SEER/SCOP for M35-71 are measured at ESP 35Pa, for M100 at ESP 37Pa, for M125/140 at ESP 50Pa.
 *5 SEER and SCOP are based on 2009/125/EC:Energy-related Products Directive and Regulation(EU) No206/2012. *6 Joint pipe is required depending on installed refrigerant pipes, outdoor units and indoor units.
 *7 The factory setting of ESP is shown without < .

PEAD-M SERIES

STANDARD INVERTER

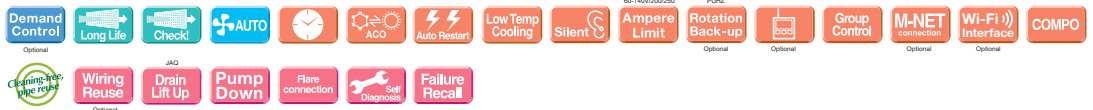

Type	Inverter Heat Pump												
Indoor Unit	PEAD-M35JAII2	PEAD-M50JAII2	PEAD-M60JAII2	PEAD-M71JAII2	PEAD-M100JAII2	PEAD-M100YKA3	PEAD-M125JAII2	PEAD-M125JAII2	PEAD-M140JAII2	PEAD-M140JAII2	PEAD-M140YKA3		
Outdoor Unit	SUZ-KA35VA6	SUZ-KA50VA6	SUZ-KA60VA6	SUZ-KA71VA6	PUHZ-P100VKA	PUHZ-P100YKA	PUHZ-P125VKA	PUHZ-P125YKA	PUHZ-P140VKA	PUHZ-P140YKA	PUHZ-P140YKA		
Refrigerant ⁽¹⁾	R410A												
Power Supply	Outdoor power supply VA-VKA:230/Single/50, YKA:400/Three/50												
Cooling	Capacity	Rated	kW	3.6	4.9	5.7	7.1	9.4	9.4	12.1	12.1	13.6	13.6
	Total Input	Min-Max	kW	1.4 - 3.9	2.3 - 5.6	2.3 - 6.3	2.8 - 8.1	3.7 - 10.6	3.7 - 10.6	5.6 - 13.0	5.6 - 13.0	5.8 - 14.1	5.8 - 14.1
		Rated	kW	1.029	1.458	1.652	2.060	2.965	2.965	4.143	4.143	5.551	5.551
	EER ⁽⁴⁾	Rated		3.50	3.36	3.45	3.45	3.17	3.17	2.92	2.92	2.45	2.45
		Design load	kW	3.6	4.9	5.7	7.1	9.4	9.4	-	-	-	-
	Annual electricity consumption ⁽²⁾	kWh/a		210	284	326	395	596	596	-	-	-	-
SEER ⁽⁴⁾⁽¹⁵⁾			6.0	6.0	6.1	6.2	5.5	5.5	-	-	-	-	
Energy efficiency class			A+	A+	A+	A+	A	A	-	-	-	-	
Heating	Capacity	Rated	kW	4.1	5.9	7.0	8.0	11.2	11.2	13.5	13.5	15.0	15.0
		Min-Max	kW	1.7 - 5.0	1.7 - 7.2	2.5 - 8.0	2.6 - 10.2	2.8 - 12.5	2.8 - 12.5	4.8 - 15.0	4.8 - 15.0	4.9 - 15.8	4.9 - 15.8
	Total Input	Rated	kW	1.111	1.620	1.928	2.040	2.947	2.947	3.739	3.739	4.347	4.347
		COP ⁽⁴⁾		3.69	3.64	3.63	3.80	3.80	3.80	3.61	3.61	3.45	3.45
	Design load	kW		2.8	4.4	4.5	6.0	8.0	8.0	-	-	-	-
		Declared Capacity	at reference design temperature	kW	2.5 (-10°C)	3.9 (-10°C)	4.1 (-10°C)	5.3 (-10°C)	6.0 (-10°C)	6.0 (-10°C)	-	-	-
		at bivalent temperature	kW	2.5 (-7°C)	3.9 (-7°C)	4.1 (-7°C)	5.3 (-7°C)	6.0 (-7°C)	6.0 (-7°C)	-	-	-	
		at operation limit temperature	kW	2.5 (-10°C)	3.9 (-10°C)	4.1 (-10°C)	5.3 (-10°C)	4.5 (-15°C)	4.5 (-15°C)	-	-	-	
	Back up heating capacity	kW		0.3	0.5	0.4	0.7	2.0	2.0	-	-	-	-
		Annual electricity consumption ⁽²⁾	kWh/a		975	1455	1559	2132	2797	2797	-	-	-
SCOP ⁽⁴⁾⁽¹⁵⁾			4.0	4.2	4.0	3.9	4.0	4.0	-	-	-	-	
Energy efficiency class			A+	A+	A+	A	A+	A+	-	-	-	-	
Operating Current(Max)	A		9.4	13.4	15.9	18.0	22.3	13.8	27.8	12.8	31.4	12.9	
Indoor Unit	Input (cooling / Heating)	Rated	kW	0.05	0.07	0.08	0.09	0.14	0.14	0.20	0.20	0.21	0.21
Outdoor Unit	Operating Current(Max)	A		1.16	1.35	1.85	1.9	2.25	2.25	2.34	2.63	2.63	
	Dimensions	H*W*D	mm	250x900x732	250x900x732	250x1100x732	250x1100x732	250x1400x732	250x1400x732	250x1400x732	250x1600x732	250x1600x732	
	Weight	kg		25(24.5)	26.5(25.5)	29.5(29)	29.5(29)	37(36)	37(36)	38(37)	42(41)	42(41)	
	Air Volume (Lo-Mid-Hi)	m³/min		10.0-12.0-14.0	12.0-14.5-17.0	14.5-18.0-21.0	14.5-18.0-23.0	23.0-28.0-32.0	23.0-28.0-32.0	28.0-34.0-37.0	28.0-34.0-37.0	29.5-35.5-40.0	
	External Static Pressure ⁽⁷⁾	Pa		35-<50-<70-<100-<150									
	Sound Level (Lo-Mid-Hi) (SPL)	dB(A)		24-29-32	27-33-35	26-32-35	26-32-37	31-36-39	31-36-39	35-39-41	35-39-41	34-38-41	
	Sound Level (PWL)	dB(A)		54	58	56	58	62	62	66	66	66	
	Dimensions	H*W*D	mm	550-800-285	880-840-330	880-840-330	880-840-330	981-1050-330	981-1050-330	981-1050-330	981-1050-330	981-1050-330	
	Weight	kg		35	54	50	53	76	84	85	84	85	
	Air Volume	Cooling	m³/min		36.3	44.6	40.9	50.1	79	79	86	86	86
		Heating	m³/min		34.8	44.6	49.2	48.2	79	79	92	92	92
	Sound Level (SPL)	Cooling	dB(A)		49	52	55	55	51	51	54	54	56
		Heating	dB(A)		50	52	55	55	54	54	56	56	57
	Sound Level (PWL)	Cooling	dB(A)		62	65	65	69	70	72	72	75	75
Heating		dB(A)		62	65	65	69	70	72	72	75	75	
Operating Current(Max)	A		8.2	12	14	16.1	20	11.5	26.5	11.5	30	11.5	
Breaker Size	A		10	20	20	20	32	16	32	16	40	16	
Ext.Piping	Diameter ⁽⁶⁾	Liquid/Gas	mm	6.35 / 9.52	6.35 / 12.7								

PEA SERIES

The PEA series is a large capacity ceiling-concealed type indoor units which are visually discreet blending into various environments. The PEA model realizes improved energy efficiency with a patented fan called Turbo In Sirocco fan. A wider option of external static pressure up to 250Pa allows authentic ducted air-conditioning with an elegant interior layout. In addition, the PEA series has a separated structure that enables delivery into a narrow space.

R32
R410A



PEA-M200/250LA2



The separated structure increases the efficiency of delivery into a narrow space.

Improved Energy Efficiency

R32 refrigerant with designed fan reduces energy consumption and have resulted in higher energy savings for all capacity ranges.

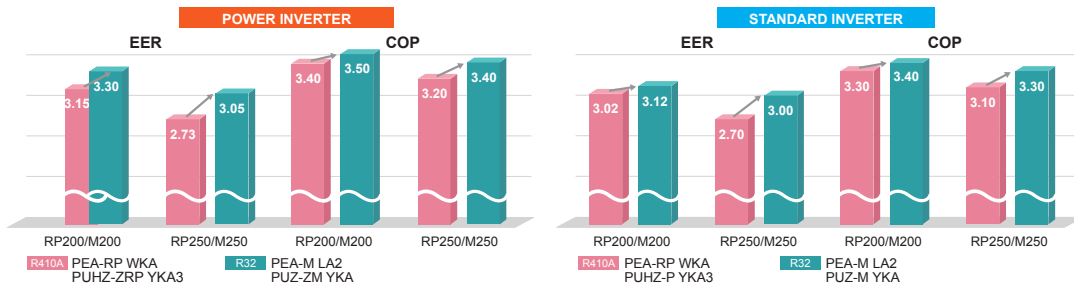

Low input with Fan Design

The PEA series applies a designed fan; a Turbo In Sirocco fan which realizes high efficiency with a lower power input. The design is Mitsubishi Electric's patented technology with a combination of turbo fan inside the sirocco fan.

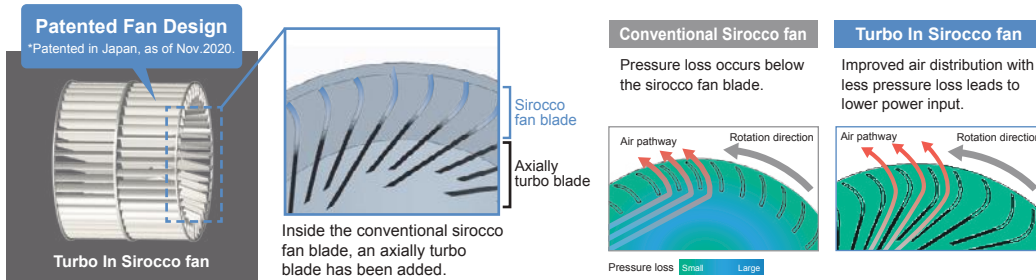

Wide range of external static pressure allows flexible duct design

250Pa setting is newly added enabling total of five static pressure level. The ability to select additional static pressure enables long duct and more freedom in design.

PEA-M200/250LA2 75/<100>/<150>/<200>/<250> Pa

The factory setting of external static pressure is shown without brackets (<>). Refer to "Fan characteristics curves" according to the external static pressure, in the DATA BOOK for the usable range of airflow rate.

PAR-41MAA Group Control

The PAR-41MAA remote controller can control up to 16 systems as a group, and is ideal for supporting the integrated management of building air conditioners.

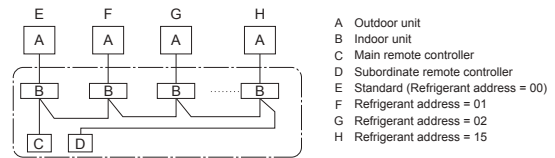

LINE-UP		
<p>Indoor Unit</p> <p>PEA-M200/250LA2</p>	<p>Outdoor Unit</p> <div style="display: flex; justify-content: space-around;"> <div style="text-align: center;"> <p>Power Inverter Series</p> <p>R410A</p> <p>PUHZ-ZRP200/250</p> </div> <div style="text-align: center;"> <p>Standard Inverter Series</p> <p>R410A</p> <p>PUHZ-P200/250</p> </div> </div> <hr/> <div style="display: flex; justify-content: space-around;"> <div style="text-align: center;"> <p>Power Inverter Series</p> <p>R32</p> <p>PUZ-ZM200/250</p> </div> <div style="text-align: center;"> <p>Standard Inverter Series</p> <p>R32</p> <p>PUZ-M200/250</p> </div> </div>	<p>Remote Controller</p> <p>Optional Optional Optional</p>

PEA-M SERIES

POWER INVERTER



Type				Inverter Heat Pump			
Indoor Unit				PEA-M200LA2		PEA-M250LA2	
Outdoor Unit				PUZ-ZM200YKA2		PUZ-ZM250YKA2	
Refrigerant ^(*)				R32			
Power Supply Source				Separate power supply			
Outdoor(V/Phase/Hz)				400/Three/50			
Cooling	Capacity	Rated	kW	19.0		22.0	
		Min-Max	kW	9.2 - 22.4		9.9 - 27.0	
	Total Input	Rated	kW	5.757		7.213	
	EER			3.30		3.05	
Heating	Capacity	Rated	kW	22.4		27.0	
		Min-Max	kW	7.1 - 25.0		7.3 - 31.0	
	Total Input	Rated	kW	6.400		7.941	
	COP			3.50		3.40	
Operating Current(Max)		A	27.3		27.3		
Indoor Unit Input [cooling / Heating]	Rated	kW	0.32		0.48		
Operating Current(Max)		A	4.8		4.8		
Dimensions	H x W x D	mm		470-1370-1120			
Weight		kg		88			
Air Volume (Lo-Mid-Hi)	Normal airflow mode	m³/min		42.0-51.0-60.0		50.0-61.0-72.0 (75Pa-200Pa)	
	High airflow mode	m³/min		50.0-61.0-72.0 (75Pa-200Pa)		58.0-72.0-84.0 (75Pa-150Pa)	
				42.0-51.0-60.0 (250Pa)		50.0-61.0-72.0 (200Pa)	
						42.0-51.0-60.0 (250Pa)	
External Static Pressure		Pa		75/(100)/(150)/(200)/(250)			
Sound Level (Lo-Mi2-Mi1-Hi) (SPL)		dB(A)		34.5-39.0-43.0		37.5-42.0-46.0	
Sound Level (PWL)		dB(A)		63.0-64.0-64.0		67.0-67.0-68.0	
Outdoor Unit Dimensions	H x W x D	mm		1338-1050-330(+40)		1338-1050-330(+40)	
	Weight	kg		137		138	
Air Volume	Cooling	m³/min		140		140	
	Heating	m³/min		140		140	
Sound Level (SPL)	Cooling	dB(A)		59		59	
	Heating	dB(A)		62		62	
Sound Level (PWL)	Cooling	dB(A)		77		77	
	Heating	dB(A)		77		77	
Operating Current(Max)		A		22.5		22.5	
Breaker Size		A		32		32	
Ext.Piping Diameter ^(*)	Liquid/Gas	mm		9.52 / 25.4		12.7 / 25.4	
	Max.Length	m		100		100	
	Max.Height	m		30		30	
Guaranteed Operating Range (Outdoor)	Cooling ^(*)	°C		-15 ~ 46		-15 ~ 46	
	Heating	°C		-20 ~ 21		-20 ~ 21	

*1 Refrigerant leakage contributes to climate change. Refrigerant with lower global warming potential (GWP) would contribute less to global warming than a refrigerant with higher GWP; if leaked to the atmosphere. This appliance contains a refrigerant fluid with a GWP equal to 1975. This means that if 1 kg of this refrigerant fluid would be leaked to the atmosphere, the impact on global warming would be 1975 times higher than 1 kg of CO₂, over a period of 100 years. Never try to interfere with the refrigerant circuit yourself or disassemble the product yourself and always ask a professional.
 *2 Optional air protection guide is required where ambient temperature is lower than -5°C.
 *3 Joint pipe is required depending on installed refrigerant pipes, outdoor units and indoor units.

PEA-M SERIES

STANDARD INVERTER



Type				Inverter Heat Pump			
Indoor Unit				PEA-M200LA2		PEA-M250LA2	
Outdoor Unit				PUZ-M200YKA2		PUZ-M250YKA2	
Refrigerant ^(*)				R32			
Power Supply Source				Separate power supply			
Outdoor(V/Phase/Hz)				400/Three/50			
Cooling	Capacity	Rated	kW	19.0		22.0	
		Min-Max	kW	9.2 - 22.4		9.9 - 27.0	
	Total Input	Rated	kW	6.089		7.333	
	EER			3.12		3.00	
Heating	Capacity	Rated	kW	22.4		27.0	
		Min-Max	kW	6.8 - 25.0		7.3 - 31.0	
	Total Input	Rated	kW	6.588		8.181	
	COP			3.40		3.30	
Operating Current(Max)		A	27.3		27.3		
Indoor Unit Input [cooling / Heating]	Rated	kW	0.32		0.48		
Operating Current(Max)		A	4.8		4.8		
Dimensions	H x W x D	mm		470-1370-1120			
Weight		kg		88			
Air Volume (Lo-Mid-Hi)	Normal airflow mode	m³/min		42.0-51.0-60.0		50.0-61.0-72.0 (75Pa-200Pa)	
	High airflow mode	m³/min		50.0-61.0-72.0 (75Pa-200Pa)		58.0-72.0-84.0 (75Pa-150Pa)	
				42.0-51.0-60.0 (250Pa)		50.0-61.0-72.0 (200Pa)	
						42.0-51.0-60.0 (250Pa)	
External Static Pressure		Pa		75/(100)/(150)/(200)/(250)			
Sound Level (Lo-Mi2-Mi1-Hi) (SPL)		dB(A)		34.5-39.0-43.0		37.5-42.0-46.0	
Sound Level (PWL)		dB(A)		63.0-64.0-64.0		67.0-67.0-68.0	
Outdoor Unit Dimensions	H x W x D	mm		1338-1050-330(+40)		1338-1050-330(+40)	
	Weight	kg		129		138	
Air Volume	Cooling	m³/min		140		140	
	Heating	m³/min		140		140	
Sound Level (SPL)	Cooling	dB(A)		58		59	
	Heating	dB(A)		60		62	
Sound Level (PWL)	Cooling	dB(A)		78		77	
	Heating	dB(A)		78		77	
Operating Current(Max)		A		22.5		22.5	
Breaker Size		A		32		32	
Ext.Piping Diameter ^(*)	Liquid/Gas	mm		9.52 / 25.4		12.7 / 25.4	
	Max.Length	m		70		70	
	Max.Height	m		30		30	
Guaranteed Operating Range (Outdoor)	Cooling ^(*)	°C		-15 ~ 46		-15 ~ 46	
	Heating	°C		-20 ~ 21		-20 ~ 21	

*1 Refrigerant leakage contributes to climate change. Refrigerant with lower global warming potential (GWP) would contribute less to global warming than a refrigerant with higher GWP; if leaked to the atmosphere. This appliance contains a refrigerant fluid with a GWP equal to 1975. This means that if 1 kg of this refrigerant fluid would be leaked to the atmosphere, the impact on global warming would be 1975 times higher than 1 kg of CO₂, over a period of 100 years. Never try to interfere with the refrigerant circuit yourself or disassemble the product yourself and always ask a professional.
 *2 Optional air protection guide is required where ambient temperature is lower than -5°C.
 *3 Joint pipe is required depending on installed refrigerant pipes, outdoor units and indoor units.

PEA-M SERIES

POWER INVERTER



Type				Inverter Heat Pump		
Indoor Unit				PEA-M200LA2	PEA-M250LA2	
Outdoor Unit				PUHZ-ZRP200YKA3	PUHZ-ZRP250YKA3	
Refrigerant ^(*)				R410A		
Power Supply	Source			Separate power supply		
	Outdoor (V/Phase/Hz)			400 / Three / 50		
Cooling	Capacity	Rated	kW	19.0	22.0	
		Min - Max	kW	9.0 - 22.4	11.2 - 27.0	
	Total Input	Rated	kW	5.937	7.971	
	EER			3.20	2.76	
Heating (Average Season)	Capacity	Rated	kW	22.4	27.0	
		Min - Max	kW	9.5 - 25.0	12.5 - 31.0	
	Total Input	Rated	kW	6.530	8.181	
	COP			3.43	3.30	
Operating Current (max)				23.8	25.8	
Indoor Unit	Input [Cooling / Heating]	Rated	kW	0.32/0.32	0.48/0.48	
	Operating Current (max)			A	4.8	
	Dimensions			H x W x D	mm	470-1370-1120
	Weight			kg	88	
	Air Volume [Lo-Mid-Hi]	Normal mode	m ³ /min		45-51-60	50-61-72
		High airflow mode	m ³ /min		50-61-72	58-72-84
	External Static Pressure			Pa	75/(100)/(150)/(200)/(250)	
	Sound Level (SPL) [Lo-Mid-Hi]			dB(A)	34.5-39.0-43.0	37.5-42.0-46.0
	Sound Level (PWL)			dB(A)	63.0-64.0-64.0	67.0-67.0-68.0
	Outdoor Unit	Dimensions			H x W x D	mm
Weight			kg	135		
Air Volume		Cooling	m ³ /min		140	140
		Heating	m ³ /min		140	140
Sound Level (SPL)		Cooling	dB(A)		59	59
		Heating	dB(A)		62	62
Sound Level (PWL)		Cooling	dB(A)		77	77
		Operating Current (max)	A		19.0	21.0
Breaker Size			A	32		
Ext. Piping		Diameter ^(*)	Liquid / Gas	mm	9.52 / 25.4	12.7 / 25.4
	Max. Length	Out-In	m	100	100	
	Max. Height	Out-In	m	30	30	
Guaranteed Operating Range (Outdoor)		Cooling ^(*)	°C	-15 ~ 46	-15 ~ 46	
		Heating	°C	-20 ~ 21	-20 ~ 21	

*1 Refrigerant leakage contributes to climate change. Refrigerant with lower global warming potential (GWP) would contribute less to global warming than a refrigerant with higher GWP, if leaked to the atmosphere. This appliance contains a refrigerant fluid with a GWP equal to 1975. This means that if 1 kg of this refrigerant fluid would be leaked to the atmosphere, the impact on global warming would be 1975 times higher than 1 kg of CO₂, over a period of 100 years. Never try to interfere with the refrigerant circuit yourself or disassemble the product yourself and always ask a professional.
 *2 Optional air protection guide is required where ambient temperature is lower than -5°C.
 *3 Joint pipe is required depending on installed refrigerant pipes, outdoor units and indoor units.

PEA-M SERIES

STANDARD INVERTER



Type				Inverter Heat Pump		
Indoor Unit				PEA-M200LA2	PEA-M250LA2	
Outdoor Unit				PUHZ-P200YKA3	PUHZ-P250YKA3	
Refrigerant ^(*)				R410A		
Power Supply	Source			Separate power supply		
	Outdoor (V/Phase/Hz)			400 / Three / 50		
Cooling	Capacity	Rated	kW	19.0	22.0	
		Min - Max	kW	9.0 - 22.4	11.2 - 27.0	
	Total Input	Rated	kW	6.188	8.058	
	EER			3.07	2.73	
Heating (Average Season)	Capacity	Rated	kW	22.4	27.0	
		Min - Max	kW	9.5 - 25.0	12.5 - 31.0	
	Total Input	Rated	kW	6.706	8.437	
	COP			3.34	3.20	
Operating Current (max)				23.8	25.8	
Indoor Unit	Input [Cooling / Heating]	Rated	kW	0.32/0.32	0.48/0.48	
	Operating Current (max)			A	4.8	
	Dimensions			H x W x D	mm	470-1370-1120
	Weight			kg	88	
	Air Volume [Lo-Mid-Hi]	Normal mode	m ³ /mi		45-51-60	50-61-72
		High airflow mode	m ³ /mi		50-61-72	58-72-84
	External Static Pressure			Pa	75/(100)/(150)/(200)/(250)	
	Sound Level (SPL) [Lo-Mid-Hi]			dB(A)	34.5-39.0-43.0	37.5-42.0-46.0
	Sound Level (PWL)			dB(A)	63.0-64.0-64.0	67.0-67.0-68.0
	Outdoor Unit	Dimensions			H x W x D	mm
Weight			kg	127		
Air Volume		Cooling	m ³ /min		140	140
		Heating	m ³ /min		140	140
Sound Level (SPL)		Cooling	dB(A)		58	59
		Heating	dB(A)		60	62
Sound Level (PWL)		Cooling	dB(A)		78	77
		Operating Current (max)	A		19.0	21.0
Breaker Size			A	32		
Ext. Piping		Diameter ^(*)	Liquid / Gas	mm	9.52 / 25.4	12.7 / 25.4
	Max. Length	Out-In	m	70	70	
	Max. Height	Out-In	m	30	30	
Guaranteed Operating Range (Outdoor)		Cooling ^(*)	°C	-15 ~ 46	-15 ~ 46	
		Heating	°C	-20 ~ 21	-20 ~ 21	

*1 Refrigerant leakage contributes to climate change. Refrigerant with lower global warming potential (GWP) would contribute less to global warming than a refrigerant with higher GWP, if leaked to the atmosphere. This appliance contains a refrigerant fluid with a GWP equal to 1975. This means that if 1 kg of this refrigerant fluid would be leaked to the atmosphere, the impact on global warming would be 1975 times higher than 1 kg of CO₂, over a period of 100 years. Never try to interfere with the refrigerant circuit yourself or disassemble the product yourself and always ask a professional.
 *2 Optional air protection guide is required where ambient temperature is lower than -5°C.
 *3 Joint pipe is required depending on installed refrigerant pipes, outdoor units and indoor units.

PKA SERIES

PKA-M35/50LA(L)2

R32
R410A

PKA-M60/71/100KA(L)2

R32
R410A



The compact, wall-mounted indoor units offer the convenience of simple installation, and a large product line-up (M35-M100 models) ensures a best-match solution. Designed for highly efficient energy savings, the PKA Series is the answer to your air conditioning needs.

New Design (M35-50)

A sharp and simple form that combines beauty and function. The simple square design harmonizes beautifully with the straight lines created by the intersection of the walls, floor and ceiling of the space, leading to a better quality of space. Also adopted a new white body color. It will make your life and space beautiful and comfortable without disturbing the atmosphere of the room. In addition, we realized miniaturization of conventional model. It contributes to space saving of installation area and giving room to room space.



Quietness (M35-50)

The noise level has been significantly reduced compared to the conventional model by reviewing the unit structure and improving the line flow fan.

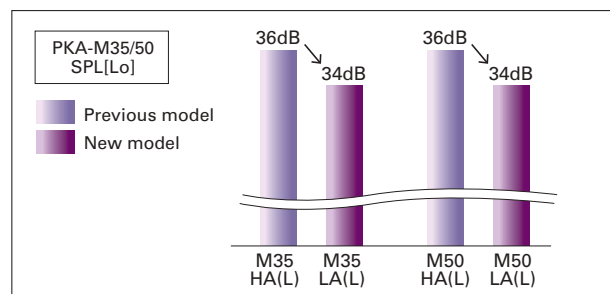

New Wireless Remote Controller Included

The PKA-KAL2 series wireless remote controller has been updated. It now comes with a new stylish remote controller that fits comfortably in your hand and has a wide range of useful functions.



- Main Functions of new Wireless Remote Controller**
- Weekly Timer
 - Backlight
 - Dual set point
 - Battery replacement sign etc...

ErP Lot 10 Compliant with High Energy-efficiency Achieving SEER/SCOP Rank A, A+ and A++

Highly efficient indoor unit heat exchangers and newly designed power inverters (PUHZ-ZM) contribute to an amazing reduction in electricity consumption throughout a year, and have resulted in models in the full-capacity range attaining the rank A, A+ and A++ energy savings rating.

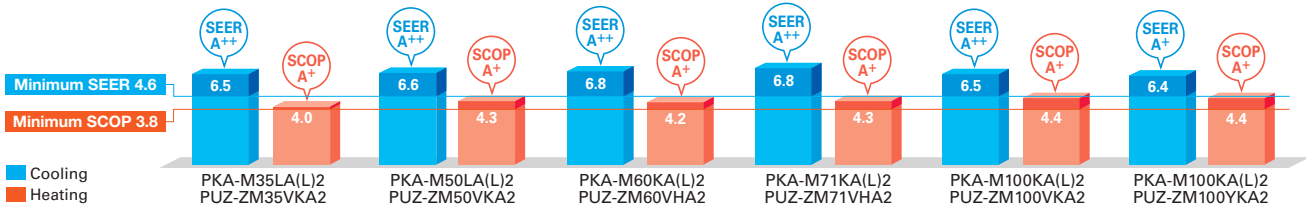

Airflow Control – Horizontal Airflow – (M35-50)

Significantly improved airflow control to achieve horizontal airflow. This reduces the feeling of draft even on a wall-mounted model, and air conditioning the indoor space firmly.

Airflow distributions

PKA-M50LA <Cooling mode> Horizontal airflow

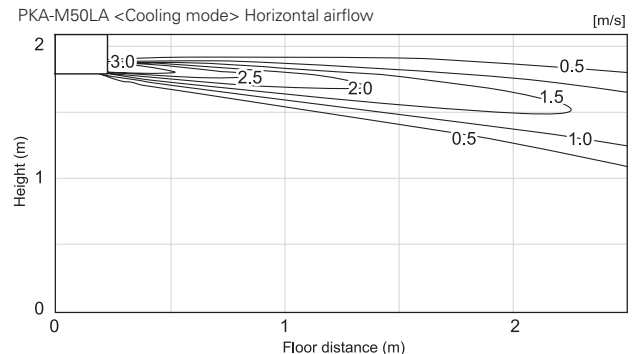

SERIES SELECTION

Power Inverter Series



Indoor Unit

R32
R410A



PKA-M35/50LA(L)2

R32
R410A



PKA-M60/71/100KA(L)2

Outdoor Unit

R32

For Single



PUZ-ZM35/50



PUZ-ZM60/71



PUZ-ZM100/125/140

R32

For Multi
(Twin/Triple/Quadruple)



PUZ-ZM71



PUZ-ZM100/125/140/200/250

Remote Controller



Optional (*)



Optional



Optional (*)



*PKA-M•KAL2/LAL2 only

(*) PAC-SH29TC-E is required for LAL and KAL (optional)

PKA-M LA(L)2/KA(L)2 Indoor Unit Combinations Indoor unit combinations shown below are possible.

Indoor Unit Combination	Outdoor Unit Capacity																			
	For Single									For Twin					For Triple			For Quadruple		
	35	50	60	71	100	125	140	200	250	71	100	125	140	200	250	140	200	250	200	250
Power Inverter (PUZ-ZM)	35x1	50x1	60x1	71x1	100x1	-	-	-	-	35x2	50x2	60x2	71x2	100x2	-	50x3	60x3	71x3	50x4	60x4
Distribution Pipe	-	-	-	-	-	-	-	-	-	MSDD-50TR2-E			MSDD-50WR2-E		MSDF-111R3-E			MSDF-111R2-E		

SERIES SELECTION

Standard Inverter Series



Indoor Unit

R32
R410A



PKA-M35/50LA(L)2



PKA-M60/71/100KA(L)2

Outdoor Unit

R32

For Single



PUZ-M100

R32

For Multi
(Twin/Triple/Quadruple)



PUZ-M100/125/140



PUZ-M200/250

Remote Controller



Optional (*)



Optional



Optional (*)



*PKA-M•KAL2/LAL2 only

(*) PAC-SH29TC-E is required for LAL and KAL (optional)

PKA-M LA(L)2/KA(L)2 Indoor Unit Combinations Indoor unit combinations shown below are possible.

Indoor Unit Combination	Outdoor Unit Capacity																			
	For Single									For Twin					For Triple			For Quadruple		
	35	50	60	71	100	125	140	200	250	71	100	125	140	200	250	140	200	250	200	250
Standard Inverter (PUZ-M)	-	-	-	-	100x1	-	-	-	-	-	50x2	60x2	71x2	100x2	-	50x3	60x3	71x3	50x4	60x4
Distribution Pipe	-	-	-	-	-	-	-	-	-	MSDD-50TR2-E			MSDD-50WR2-E		MSDF-111R3-E			MSDF-111R2-E		

PKA-M SERIES

POWER INVERTER



Type		Inverter Heat Pump								
Indoor Unit		PKA-M35LA(L)2	PKA-M50LA(L)2	PKA-M60KA(L)2	PKA-M71KA(L)2	PKA-M100KA(L)2	PKA-M100KA(L)2			
Outdoor Unit		PUZ-MZ35VKA2	PUZ-MZ50VKA2	PUZ-MZ60VHA2	PUZ-MZ71VHA2	PUZ-MZ100VKA2	PUZ-MZ100VKA2			
Refrigerant ⁽¹⁾		R32								
Power Supply		Outdoor power supply								
Cooling		VKA·VHA:230/Single/50, YKA:400/Three/50								
Cooling	Capacity	Rated	kW	3.6	4.6	6.1	7.1	9.5	9.5	
		Min-Max	kW	1.6 - 4.5	2.3 - 5.6	2.7 - 6.7	3.3 - 8.1	4.9 - 11.4	4.9 - 11.4	
	Total Input	Rated	kW	0.857	1.239	1.560	1.863	2.435	2.435	
	EER	Rated	kW	4.20	3.71	3.91	3.81	3.90	3.90	
	Design load		kW	3.6	4.6	6.1	7.1	9.5	9.5	
	Annual electricity consumption ⁽²⁾		kWh/a	194	244	314	365	508	519	
	SEER ⁽⁴⁾			6.5	6.6	6.8	6.8	6.5	6.4	
	Energy efficiency class				A++	A++	A++	A++	A++	A++
	Heating	Capacity	Rated	kW	4.1	5.0	7.0	8.0	11.2	11.2
			Min-Max	kW	1.6 - 5.2	2.5 - 7.0	2.8 - 8.2	3.5 - 10.2	4.5 - 14.0	4.5 - 14.0
Total Input		Rated	kW	1.040	1.344	1.732	2.116	3.102	3.102	
COP				3.94	3.72	4.04	3.78	3.61	3.61	
Design load			kW	2.4	3.3	4.4	4.7	7.8	7.8	
Declared Capacity		at reference design temperature	kW	2.4 (-10°C)	3.3 (-10°C)	4.4 (-10°C)	4.7 (-10°C)	7.8 (-10°C)	7.8 (-10°C)	
		at bivalent temperature	kW	2.4 (-10°C)	3.3 (-10°C)	4.4 (-10°C)	4.7 (-10°C)	7.8 (-10°C)	7.8 (-10°C)	
		at operation limit temperature	kW	2.2 (-11°C)	3.2 (-11°C)	2.8 (-20°C)	3.4 (-20°C)	5.8 (-20°C)	5.8 (-20°C)	
Back up heating capacity			kW	0.0	0.0	0.0	0.0	0.0	0.0	
Annual electricity consumption ⁽²⁾			kWh/a	829	1074	1464	1530	2477	2478	
SCOP ⁽⁴⁾			4.0	4.3	4.2	4.3	4.4	4.4		
Energy efficiency class				A+	A+	A+	A+	A+	A+	
Operating Current(Max)		A	13.4	13.4	19.4	19.4	20.6	8.6		
Indoor Unit	Input [cooling / Heating]	Rated	kW	0.04 / 0.03	0.04 / 0.03	0.06 / 0.05	0.06 / 0.05	0.08 / 0.07	0.08 / 0.07	
	Operating Current(Max)		A	0.35	0.35	0.43	0.43	0.57	0.57	
	Dimensions	H*W*D	mm	299-898-237	299-898-237	365-1170-295	365-1170-295	365-1170-295	365-1170-295	
	Weight		kg	12.6	12.6	21	21	21	21	
	Air Volume (Lo-Mi2-Mi1-Hi)		m³/min	7.5-8.2-9.2-10.9	7.5-8.2-9.2-10.9	18-20-22	18-20-22	20-23-26	20-23-26	
	Sound Level (Lo-Mi2-Mi1-Hi) (SPL)		dB(A)	34-37-40-43	34-37-40-43	39-42-45	39-42-45	41-45-49	41-45-49	
	Sound Level (PWL)		dB(A)	60	60	64	64	65	65	
	Outdoor Unit	Dimensions	H*W*D	mm	630-809-300	630-809-300	943-950-330(+25)	943-950-330(+25)	1338-1050-330(+40)	1338-1050-330(+40)
		Weight		kg	46	46	67	67	105	111
		Air Volume	Cooling	m³/min	45	45	55	55	110	110
Heating			m³/min	45	45	55	55	110	110	
Sound Level (SPL)		Cooling	dB(A)	44	44	47	47	49	49	
		Heating	dB(A)	46	46	49	49	51	51	
Sound Level (PWL)		Cooling	dB(A)	65	65	67	67	69	69	
		Heating	dB(A)	65	65	67	67	69	69	
Operating Current(Max)			A	13	13	19	19	20	8	
Breaker Size			A	16	16	25	25	32	16	
Ext.Piping	Diameter ⁽³⁾	Liquid/Gas	mm	6.35 / 12.7	6.35 / 12.7	9.52 / 15.88	9.52 / 15.88	9.52 / 15.88	9.52 / 15.88	
	Max.Length	Out-In	m	50	50	55	55	100	100	
	Max.Height	Out-In	m	30	30	30	30	30	30	
Guaranteed Operating Range (Outdoor)	Cooling ⁽³⁾	°C	-15 ~ +46	-15 ~ +46	-15 ~ +46	-15 ~ +46	-15 ~ +46	-15 ~ +46		
	Heating	°C	-11 ~ +21	-11 ~ +21	-20 ~ +21	-20 ~ +21	-20 ~ +21	-20 ~ +21		

*1 Refrigerant leakage contributes to climate change. Refrigerant with lower global warming potential (GWP) would contribute less to global warming than a refrigerant with higher GWP if leaked to the atmosphere. This appliance contains a refrigerant fluid with a GWP equal to 550. This means that if 1 kg of this refrigerant fluid would be leaked to the atmosphere, the impact on global warming would be 550 times higher than 1 kg of CO₂ over a period of 100 years. Never try to interfere with the refrigerant circuit yourself or disassemble the product yourself and always ask a professional. The GWP of R32 is 675 in the IPCC 4th Assessment Report.
 *2 Energy consumption based on standard test results. Actual energy consumption will depend on how the appliance is used and where it is located.
 *3 Optional air protection guide is required where ambient temperature is lower than -5°C. *4 SEER and SCOP are based on 2009/125/EC:Energy-related Products Directive and Regulation(EU) No206/2012.
 *5 Joint pipe is required depending on installed refrigerant pipes, outdoor units and indoor units.

PKA-M SERIES

STANDARD INVERTER



Type		Inverter Heat Pump							
Indoor Unit		PKA-M100KA(L)2							
Outdoor Unit		PUZ-M100VKA2					PUZ-M100YKA2		
Refrigerant ⁽¹⁾		R32							
Power Supply		Outdoor power supply							
Cooling		VKA·VHA:230/Single/50, YKA:400/Three/50							
Cooling	Capacity	Rated	kW	9.5			9.5		
		Min-Max	kW	4.0 - 10.6			4.0 - 10.6		
	Total Input	Rated	kW	2.941			2.941		
	EER	Rated		3.23			3.23		
	Design load		kW	9.5			9.5		
	Annual electricity consumption ⁽²⁾		kWh/a	573			573		
	SEER ⁽⁴⁾			5.8			5.8		
	Energy efficiency class				A+			A+	
	Heating	Capacity	Rated	kW	11.2			11.2	
			Min-Max	kW	2.8 - 12.5			2.8 - 12.5	
Total Input		Rated	kW	3.284			3.284		
COP				3.41			3.41		
Design load			kW	8.0			8.0		
Declared Capacity		at reference design temperature	kW	6.0 (-10°C)			6.0 (-10°C)		
		at bivalent temperature	kW	7.0 (-7°C)			7.0 (-7°C)		
		at operation limit temperature	kW	4.5 (-15°C)			4.5 (-15°C)		
Back up heating capacity			kW	2.0			2.0		
Annual electricity consumption ⁽²⁾			kWh/a	2780			2780		
SCOP ⁽⁴⁾			4.0			4.0			
Energy efficiency class				A+			A+		
Operating Current(Max)		A	20.6			12.1			
Indoor Unit	Input [cooling / Heating]	Rated	kW	0.08 / 0.07			0.08 / 0.07		
	Operating Current(Max)		A	0.57			0.57		
	Dimensions	H*W*D	mm	365-1170-295			365-1170-295		
	Weight		kg	21			21		
	Air Volume (Lo-Mi2-Mi1-Hi)		m³/min	20-23-26			20-23-26		
	Sound Level (Lo-Mi2-Mi1-Hi) (SPL)		dB(A)	41-45-49			41-45-49		
	Sound Level (PWL)		dB(A)	65			65		
	Outdoor Unit	Dimensions	H*W*D	mm	981-1050-330 (+40)			981-1050-330(+40)	
		Weight		kg	76			78	
		Air Volume	Cooling	m³/min	79			79	
Heating			m³/min	79			79		
Sound Level (SPL)		Cooling	dB(A)	51			51		
		Heating	dB(A)	54			54		
Sound Level (PWL)		Cooling	dB(A)	70			70		
		Heating	dB(A)	70			70		
Operating Current(Max)			A	20.0			11.5		
Breaker Size			A	32			16		
Ext.Piping	Diameter ⁽³⁾	Liquid/Gas	mm	9.52 / 15.88			9.52 / 15.88		
	Max.Length	Out-In	m	55			55		
	Max.Height	Out-In	m	30			30		
Guaranteed Operating Range (Outdoor)	Cooling ⁽³⁾	°C	-15 ~ +46			-15 ~ +46			
	Heating	°C	-15 ~ +21			-15 ~ +21			

*1 Refrigerant leakage contributes to climate change. Refrigerant with lower global warming potential (GWP) would contribute less to global warming than a refrigerant with higher GWP if leaked to the atmosphere. This appliance contains a refrigerant fluid with a GWP equal to 550. This means that if 1 kg of this refrigerant fluid would be leaked to the atmosphere, the impact on global warming would be 550 times higher than 1 kg of CO₂ over a period of 100 years. Never try to interfere with the refrigerant circuit yourself or disassemble the product yourself and always ask a professional. The GWP of R32 is 675 in the IPCC 4th Assessment Report.
 *2 Energy consumption based on standard test results. Actual energy consumption will depend on how the appliance is used and where it is located.
 *3 Optional air protection guide is required where ambient temperature is lower than -5°C.
 *4 SEER and SCOP are based on 2009/125/EC:Energy-related Products Directive and Regulation(EU) No206/2012. *5 Joint pipe is required depending on installed refrigerant pipes, outdoor units and indoor units.

SERIES SELECTION

Power Inverter Series



Indoor Unit

R32
R410A

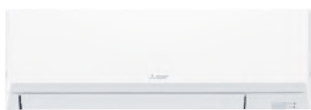

PKA-M35/50LA(L)2



PKA-M60/71/100KA(L)2

Outdoor Unit

R410A

For Single



PUHZ-ZRP35/50



PUHZ-ZRP60/71



PUHZ-ZRP100

R410A

For Multi
(Twin/Triple/Quadruple)



PUHZ-ZRP71



PUHZ-ZRP100/125/140/200/250

Remote Controller



Optional (*)



Optional



Optional (*)



*PKA-M•KAL2/LAL2 only

(*) PAC-SH29TC-E is required for LAL and KAL (optional)

PKA-M LA(L)/KA(L) Indoor Unit Combinations Indoor unit combinations shown below are possible.

Indoor Unit Combination	Outdoor Unit Capacity																			
	For Single									For Twin					For Triple			For Quadruple		
	35	50	60	71	100	125	140	200	250	71	100	125	140	200	250	140	200	250	200	250
Power Inverter (PUHZ-ZRP)	35x1	50x1	60x1	71x1	100x1	-	-	-	-	35x2	50x2	60x2	71x2	100x2	-	50x3	60x3	71x3	50x4	60x4
Distribution Pipe	-	-	-	-	-	-	-	-	-	MSDD-50TR-E			MSDD-50WR-E		-	MSDT-111R-E			MSDF-1111R-E	

SERIES SELECTION

Standard Inverter Series



Indoor Unit

R32
R410A



PKA-M35/50LA(L)2



PKA-M60/71/100KA(L)2

Outdoor Unit

R410A

For Single



PUHZ-P100

R410A

For Multi
(Twin/Triple/Quadruple)



PUHZ-P100/125/140



PUHZ-P200/250

Remote Controller



Optional (*)



Optional



Optional (*)



*PKA-M•KAL2/LAL2 only

(*) PAC-SH29TC-E is required for LAL and KAL (optional)

PKA-M LA/KA Indoor Unit Combinations Indoor unit combinations shown below are possible.

Indoor Unit Combination	Outdoor Unit Capacity																			
	For Single									For Twin					For Triple			For Quadruple		
	35	50	60	71	100	125	140	200	250	71	100	125	140	200	250	140	200	250	200	250
Standard Inverter (PUHZ-P)	-	-	-	-	100x1	-	-	-	-	-	50x2	60x2	71x2	100x2	-	50x3	60x3	71x3	50x4	60x4
Distribution Pipe	-	-	-	-	-	-	-	-	-	MSDD-50TR-E			MSDD-50WR-E		-	MSDT-111R-E			MSDF-1111R-E	

PKA-M SERIES

POWER INVERTER



Type		Inverter Heat Pump													
Indoor Unit		PKA-M35LA(L)I2		PKA-M50LA(L)I2		PKA-M60KA(L)I2		PKA-M71KA(L)I2		PKA-M100KA(L)I2		PKA-M100KA(L)I2			
Outdoor Unit		PUHZ-ZRP35VKA2		PUHZ-ZRP50VKA2		PUZ-ZRP60VHA2		PUHZ-ZRP71VHA2		PUHZ-ZRP100VKA3		PUHZ-ZRP100YKA3			
Refrigerant ⁽¹⁾		R410A													
Power Source		Outdoor power supply													
Supply Outdoor(V/Phase/Hz)		VKA·VHA:230/Single/50, YKA:400/Three/50													
Cooling	Capacity	Rated	kW		3.6		4.6		6.1		7.1		9.5		
		Min-Max	kW		1.6 - 4.5		2.3 - 5.4		2.7 - 6.7		3.3 - 8.1		4.9 - 11.4		
	Total Input	Rated	kW		0.940		1.424		1.601		1.802		2.398		
	EER				3.80		3.23		3.81		3.94		3.96		
	Design load		kW		3.6		4.6		6.1		7.1		9.5		
Heating	Annual electricity consumption ⁽²⁾		kWh/a		206		263		324		367		522		
	SEER ⁽⁴⁾				6.1		6.1		6.5		6.7		6.3		
	Energy efficiency class		A++		A++		A++		A++		A++		A++		
	Capacity	Rated	kW		4.1		5.0		7.0		8.0		11.2		
	Total Input	Rated	kW		1.6 - 5.2		2.5 - 7.3		2.8 - 8.2		3.5 - 10.2		4.5 - 14.0		
Operating	COP				3.83		3.33		3.57		3.65		3.68		
	Design load		kW		2.4		3.3		4.4		4.7		7.8		
	Declared Capacity	at reference design temperature		kW		2.4 (-10°C)		3.3 (-10°C)		4.4 (-10°C)		4.7 (-10°C)		7.8 (-10°C)	
		at bivalent temperature		kW		2.4 (-10°C)		3.3 (-10°C)		4.4 (-10°C)		4.7 (-10°C)		7.8 (-10°C)	
		at operation limit temperature		kW		2.2 (-11°C)		3.2 (-11°C)		2.8 (-20°C)		3.5 (-20°C)		5.8 (-20°C)	
	Back up heating capacity		kW		0.0		0.0		0.0		0.0		0.0		
	Annual electricity consumption ⁽²⁾		kWh/a		841		1126		1466		1529		2659		
	SCOP ⁽⁴⁾		A		A+		A+		A+		A+		A+		
	Energy efficiency class		A		A		A		A		A		A		
	Current(Max)		A		13.4		13.4		19.4		19.4		27.1		
Indoor Unit	Input [cooling / Heating]	Rated	kW		0.04 / 0.03		0.04 / 0.03		0.06 / 0.05		0.06 / 0.05		0.08 / 0.07		
	Operating Current(Max)		A		0.35		0.35		0.43		0.43		0.57		
	Dimensions	H*W*D	mm		299-899-237		299-899-237		365-1170-295		365-1170-295		365-1170-295		
	Weight		kg		12.6		12.6		21		21		21		
	Air Volume (Lo-Mi2-Mi1-Hi)		m³/min		7.5-8.2-9.2-10.9		7.5-8.2-9.2-10.9		18-20-22		18-20-22		20-23-26		
	Sound Level (Lo-Mi2-Mi1-Hi) (SPL)		dB(A)		34-37-40-43		34-37-40-43		39-42-45		39-42-45		41-45-49		
	Sound Level (PWL)		dB(A)		60		60		64		64		65		
	Dimensions	H*W*D	mm		630-809-300		630-809-300		943-950-330(+30)		943-950-330(+30)		1338-1050-330(+40)		
	Weight		kg		43		46		70		70		123		
	Air Volume	Cooling	m³/min		45		45		55		55		110		
Sound Level (SPL)	Heating	m³/min		45		45		55		55		110			
	Cooling	dB(A)		44		44		47		47		49			
Sound Level (PWL)	Heating	dB(A)		46		46		48		48		51			
	Cooling	dB(A)		65		65		67		67		69			
Operating Current(Max)		A		13		13		19		19		26.5			
Breaker Size		A		16		16		25		25		32			
Ext.Piping	Diameter ⁽⁵⁾	Liquid/Gas	mm		6.35 / 12.7		6.35 / 12.7		9.52 / 15.88		9.52 / 15.88		9.52 / 15.88		
	Max.Length	Out-In	m		50		50		50		50		75		
	Max.Height	Out-In	m		30		30		30		30		30		
Guaranteed Operating Range (Outdoor)	Cooling ⁽³⁾		°C		-15 ~ +46		-15 ~ +46		-15 ~ +46		-15 ~ +46		-15 ~ +46		
	Heating		°C		-11 ~ +21		-11 ~ +21		-20 ~ +21		-20 ~ +21		-20 ~ +21		

*1 Refrigerant leakage contributes to climate change. Refrigerant with lower global warming potential (GWP) would contribute less to global warming than a refrigerant with higher GWP. If leaked to the atmosphere. This appliance contains a refrigerant fluid with a GWP equal to 550. This means that if 1 kg of this refrigerant fluid would be leaked to the atmosphere, the impact on global warming would be 550 times higher than 1 kg of CO₂ over a period of 100 years. Never try to interfere with the refrigerant circuit yourself or disassemble the product yourself and always ask a professional. The GWP of R32 is 675 in the IPCC 4th Assessment Report.
 *2 Energy consumption based on standard test results. Actual energy consumption will depend on how the appliance is used and where it is located.
 *3 Optional air protection guide is required where ambient temperature is lower than -5°C.
 *4 SEER and SCOP are based on 2009/125/EC:Energy-related Products Directive and Regulation(EU) No206/2012.
 *5 Joint pipe is required depending on installed refrigerant pipes, outdoor units and indoor units.

PKA-M SERIES

STANDARD INVERTER



Type		Inverter Heat Pump											
Indoor Unit		PKA-M100KA(L)I2											
Outdoor Unit		PUHZ-P100VKA				PUHZ-P100YKA							
Refrigerant ⁽¹⁾		R410A											
Power Source		Outdoor power supply											
Supply Outdoor(V/Phase/Hz)		VKA·VHA:230/Single/50, YKA:400/Three/50											
Cooling	Capacity	Rated	kW		9.4		9.4		9.4		9.4		
		Min-Max	kW		3.7 - 10.6		3.7 - 10.6		3.7 - 10.6		3.7 - 10.6		
	Total Input	Rated	kW		3.122		3.122		3.122		3.122		
	EER				3.01		3.01		3.01		3.01		
	Design load		kW		9.4		9.4		9.4		9.4		
Heating	Annual electricity consumption ⁽²⁾		kWh/a		586		586		586		586		
	SEER ⁽⁴⁾				5.6		5.6		5.6		5.6		
	Energy efficiency class		A+		A+		A+		A+		A+		
	Capacity	Rated	kW		11.2		11.2		11.2		11.2		
	Total Input	Rated	kW		2.8 - 12.5		2.8 - 12.5		2.8 - 12.5		2.8 - 12.5		
Operating	COP				3.489		3.489		3.489		3.489		
	Design load		kW		8.0		8.0		8.0		8.0		
	Declared Capacity	at reference design temperature		kW		6.0 (-10°C)		6.0 (-10°C)		6.0 (-10°C)		6.0 (-10°C)	
		at bivalent temperature		kW		7.0 (-7°C)		7.0 (-7°C)		7.0 (-7°C)		7.0 (-7°C)	
		at operation limit temperature		kW		4.5 (-15°C)		4.5 (-15°C)		4.5 (-15°C)		4.5 (-15°C)	
	Back up heating capacity		kW		2.0		2.0		2.0		2.0		
	Annual electricity consumption ⁽²⁾		kWh/a		2799		2799		2799		2799		
	SCOP ⁽⁴⁾		A+		A+		A+		A+		A+		
	Energy efficiency class		A+		A+		A+		A+		A+		
	Current(Max)		A		20.6		20.6		20.6		20.6		
Indoor Unit	Input [cooling / Heating]	Rated	kW		0.08 / 0.07		0.08 / 0.07		0.08 / 0.07		0.08 / 0.07		
	Operating Current(Max)		A		0.57		0.57		0.57		0.57		
	Dimensions	H*W*D	mm		365-1170-295		365-1170-295		365-1170-295		365-1170-295		
	Weight		kg		21		21		21		21		
	Air Volume (Lo-Mi2-Mi1-Hi)		m³/min		20-23-26		20-23-26		20-23-26		20-23-26		
	Sound Level (Lo-Mi2-Mi1-Hi) (SPL)		dB(A)		41-45-49		41-45-49		41-45-49		41-45-49		
	Sound Level (PWL)		dB(A)		65		65		65		65		
	Dimensions	H*W*D	mm		981-1050-330		981-1050-330		981-1050-330		981-1050-330		
	Weight		kg		76		78		78		78		
	Air Volume	Cooling	m³/min		79		79		79		79		
Sound Level (SPL)	Heating	m³/min		79		79		79		79			
	Cooling	dB(A)		51		51		51		51			
Sound Level (PWL)	Heating	dB(A)		54		54		54		54			
	Cooling	dB(A)		70		70		70		70			
Operating Current(Max)		A		20		20		11.5		11.5			
Breaker Size		A		32		32		16		16			
Ext.Piping	Diameter ⁽⁵⁾	Liquid/Gas	mm		9.52 / 15.88		9.52 / 15.88		9.52 / 15.88		9.52 / 15.88		
	Max.Length	Out-In	m		50		50		50		50		
	Max.Height	Out-In	m		30		30		30		30		
Guaranteed Operating Range (Outdoor)	Cooling ⁽³⁾		°C		-15 ~ +46		-15 ~ +46		-15 ~ +46		-15 ~ +46		
	Heating		°C		-15 ~ +21		-15 ~ +21		-15 ~ +21		-15 ~ +21		

*1 Refrigerant leakage contributes to climate change. Refrigerant with lower global warming potential (GWP) would contribute less to global warming than a refrigerant with higher GWP. If leaked to the atmosphere. This appliance contains a refrigerant fluid with a GWP equal to 550. This means that if 1 kg of this refrigerant fluid would be leaked to the atmosphere, the impact on global warming would be 550 times higher than 1 kg of CO₂ over a period of 100 years. Never try to interfere with the refrigerant circuit yourself or disassemble the product yourself and always ask a professional. The GWP of R32 is 675 in the IPCC 4th Assessment Report.
 *2 Energy consumption based on standard test results. Actual energy consumption will depend on how the appliance is used and where it is located.
 *3 Optional air protection guide is required where ambient temperature is lower than -5°C.
 *4 SEER and SCOP are based on 2009/125/EC:Energy-related Products Directive and Regulation(EU) No206/2012.
 *5 Joint pipe is required depending on installed refrigerant pipes, outdoor units and indoor units.

PCA-KA SERIES



PCA-M35/50/60/71/100/125/140KA2



A stylish new indoor unit design and airflow settings for both high- and low-ceiling interiors expand installation possibilities. Together with exceptional energy-saving performance, these units are the solution to diversified air conditioning needs.

Stylish Indoor Unit Design

A stylish square-like design is adopted for the indoor units of all models. As a result, the units blend in better with the ceiling.



PCA-KA

ErP Lot 10 Compliant with High Energy-efficiency Achieving SEER/SCOP Rank A, A+ and A++

A direct-current (DC) fan motor is installed in the indoor unit, increasing the seasonal energy efficiency of newly designed Power Inverter series (PUHZ-ZM) and resulting in the full capacity models comply ErP Lot 10 with energy ranking A+/A++ for cooling and A/A+ for heating. This contribute to an impressive reduction in the cost of annual electricity.

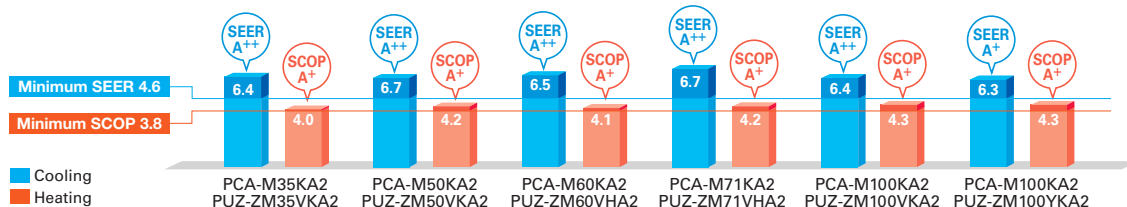

Optional Drain Pump for Full-capacity Models

The pumping height of the optional drain pump has been increased from 400mm to 600mm, expanding flexibility in choosing unit location during installation work.

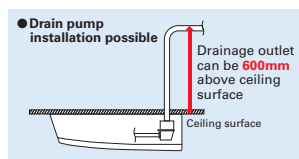

Outside-air Intake

Units are equipped with a knock-out hole that enables the induction of fresh outside-air.

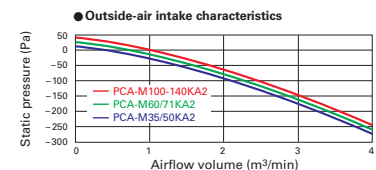

Equipped with Automatic Air-speed Adjustment

In addition to the conventional 4-speed setting, units are now equipped with an automatic air-speed adjustment mode. This setting automatically adjusts the air-speed to conditions that match the room environment. At the start of heating/cooling operation, the airflow is set to high-speed to quickly heat/cool the room. When the room temperature reaches the desired setting, the airflow speed is decreased automatically for stable comfortable heating/cooling operation.

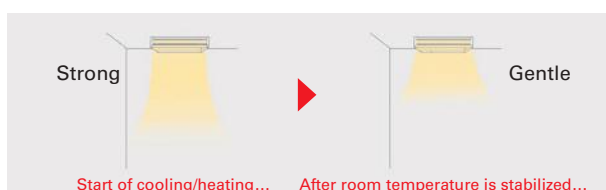

Equipped with High- /Low-ceiling Modes

Units are equipped with high- and low-ceiling operation modes that make it possible to switch the airflow volume to match room height. The ability to choose the optimum airflow volume makes it possible to optimize the breezy sensation felt throughout the room.

Capacity	High ceiling	Standard ceiling	Low ceiling
35	3.5m	2.7m	2.5m
50	3.5m	2.7m	2.5m
60	3.5m	2.7m	2.5m
71	3.5m	2.7m	2.5m
100	4.2m	3.0m	2.6m
125	4.2m	3.0m	2.6m
140	4.2m	3.0m	2.6m

SERIES SELECTION

Power Inverter Series



Indoor Unit

R32
R410A



PCA-M35/50/60/71/100/125/140KA2

Outdoor Unit

R32

For Single



PUZ-ZM35/50



PUZ-ZM60/71



PUZ-ZM100/125/140

R32

For Multi
(Twin/Triple/Quadruple)



PUZ-ZM71



PUZ-ZM100/125/140/200/250

Remote Controller



Optional



Optional



Optional



Optional



Optional*

* PAR-SA9CA is also required.

PCA-M Indoor Unit Combinations Indoor unit combinations shown below are possible.

Indoor Unit Combination	Outdoor Unit Capacity																			
	For Single									For Twin						For Triple			For Quadruple	
	35	50	60	71	100	125	140	200	250	71	100	125	140	200	250	140	200	250	200	250
Power Inverter (PUZ-ZM)	35x1	50x1	60x1	71x1	100x1	125x1	140x1	-	-	35x2	50x2	60x2	71x2	100x2	125x2	50x3	60x3	71x3	50x4	60x4
Distribution Pipe	-	-	-	-	-	-	-	-	-	MSDD-50TR2-E			MSDD-50WR2-E			MSDT-111R3-E			MSDF-111R2-E	

SERIES SELECTION

Standard Inverter Series



Indoor Unit

R32
R410A



PCA-M35/50/60/71/100/125/140KA2

Outdoor Unit

R32

For Single



SUZ-M35



SUZ-M50



SUZ-M60/71



PUZ-M100/125/140

R32

For Multi
(Twin/Triple/Quadruple)



PUZ-M100/125/140



PUZ-M200/250

Remote Controller



Optional



Optional



Optional



Optional



Optional*

* PAR-SA9CA is also required.

PCA-M Indoor Unit Combinations Indoor unit combinations shown below are possible.

Indoor Unit Combination	Outdoor Unit Capacity																			
	For Single									For Twin						For Triple			For Quadruple	
	35	50	60	71	100	125	140	200	250	71	100	125	140	200	250	140	200	250	200	250
Standard Inverter (PUZ-M&SUZ)	35x1	50x1	60x1	71x1	100x1	125x1	140x1	-	-	50x2	60x2	71x2	100x2	125x2	50x3	60x3	71x3	50x4	60x4	
Distribution Pipe	-	-	-	-	-	-	-	-	-	MSDD-50TR2-E			MSDD-50WR2-E			MSDT-111R3-E			MSDF-111R2-E	

PCA-M KA SERIES

POWER INVERTER



Type		Inverter Heat Pump											
Indoor Unit		PCA-M35KA2	PCA-M50KA2	PCA-M60KA2	PCA-M71KA2	PCA-M100KA2	PCA-M100KA2	PCA-M125KA2	PCA-M125KA2	PCA-M140KA2	PCA-M140KA2	PCA-M140KA2	
Outdoor Unit		PUZ-ZM35VKA2	PUZ-ZM50VKA2	PUZ-ZM60VHA2	PUZ-ZM71VHA2	PUZ-ZM100VKA2	PUZ-ZM100VKA2	PUZ-ZM125VKA2	PUZ-ZM125VKA2	PUZ-ZM140VKA2	PUZ-ZM140VKA2	PUZ-ZM140VKA2	
Refrigerant ⁽¹⁾		R32											
Power Supply		Outdoor power supply VKA-VHA:230/Single/50, YKA:400/Three/50											
Cooling	Capacity	Rated	kW	3.6	5.0	6.1	7.1	9.5	9.5	12.5	12.5	13.4	13.4
	Min-Max		kW	1.6 - 4.5	2.3 - 5.6	2.7 - 6.7	3.3 - 8.1	4.9 - 11.4	4.9 - 11.4	5.5 - 14.0	5.5 - 14.0	6.2 - 15.0	6.2 - 15.0
	Total Input	Rated	kW	0.829	1.250	1.521	1.829	2.375	2.375	3.846	3.846	3.941	3.941
	EER			4.34	4.00	4.01	3.88	4.00	4.00	3.25	3.25	3.40	3.40
Heating	Capacity	Rated	kW	4.1	5.5	7.0	8.0	11.2	11.2	14.0	14.0	16.0	16.0
	Min-Max		kW	1.6 - 5.2	2.5 - 6.6	2.8 - 8.2	3.5 - 10.2	4.5 - 14.0	4.5 - 14.0	5.0 - 16.0	5.0 - 16.0	5.7 - 18.0	5.7 - 18.0
	Total Input	Rated	kW	1.019	1.361	1.745	2.156	3.018	3.018	3.954	3.954	4.432	4.432
	COP			4.02	4.04	4.01	3.71	3.71	3.71	3.54	3.54	3.61	3.61

*1 Refrigerant leakage contributes to climate change. Refrigerant with lower global warming potential (GWP) would contribute less to global warming than a refrigerant with higher GWP, if leaked to the atmosphere. This appliance contains a refrigerant fluid with a GWP equal to 550. This means that if 1 kg of this refrigerant fluid would be leaked to the atmosphere, the impact on global warming would be 550 times higher than 1 kg of CO₂, over a period of 100 years. Never try to interfere with the refrigerant circuit yourself or disassemble the product yourself and always ask a professional. The GWP of R32 is 675 in the IPCC 4th Assessment Report.

*2 Energy consumption based on standard test results. Actual energy consumption will depend on how the appliance is used and where it is located.

*3 Optional air protection guide is required where ambient temperature is lower than -5°C.

*4 SEER and SCOP are based on 2009/125/EC:Energy-related Products Directive and Regulation(EU) No206/2012.

*5 Joint pipe is required depending on installed refrigerant pipes, outdoor units and indoor units.

PCA-M KA SERIES

STANDARD INVERTER



Type		Inverter Heat Pump											
Indoor Unit		PCA-M35KA2	PCA-M50KA2	PCA-M60KA2	PCA-M71KA2	PCA-M100KA2	PCA-M100KA2	PCA-M125KA2	PCA-M125KA2	PCA-M140KA2	PCA-M140KA2	PCA-M140KA2	
Outdoor Unit		SUZ-M35VA	SUZ-M50VA	SUZ-M60VA	SUZ-M71VA	PUZ-M100VKA2	PUZ-M100VKA2	PUZ-M125VKA2	PUZ-M125VKA2	PUZ-M140VKA2	PUZ-M140VKA2	PUZ-M140VKA2	
Refrigerant ⁽¹⁾		R32											
Power Supply		Outdoor power supply VA-VKA:230/Single/50, YKA:400/Three/50											
Cooling	Capacity	Rated	kW	3.6	5.0	6.1	7.1	9.5	9.5	12.1	12.1	13.4	13.4
	Min-Max		kW	0.8 - 3.9	1.5 - 5.6	1.6 - 6.3	2.2 - 8.1	4.0 - 10.6	4.0 - 10.6	5.7 - 13.0	5.7 - 13.0	5.7 - 14.1	5.7 - 14.1
	Total Input	Rated	kW	0.900	1.151	1.648	1.972	2.941	2.941	4.019	4.019	5.360	5.360
	EER			4.00	3.30	3.70	3.60	3.23	3.23	3.01	3.01	2.50	2.50
Heating	Capacity	Rated	kW	4.1	6.0	7.0	8.0	11.2	11.2	13.5	13.5	15.0	15.0
	Min-Max		kW	1.0 - 5.0	1.5 - 7.2	1.6 - 8.0	2.0 - 10.2	2.8 - 12.5	2.8 - 12.5	4.1 - 15.0	4.1 - 15.0	4.2 - 15.8	4.2 - 15.8
	Total Input	Rated	kW	1.025	1.617	1.750	2.216	3.284	3.284	3.958	3.958	4.285	4.285
	COP			4.00	3.71	4.00	3.61	3.41	3.41	3.41	3.41	3.50	3.50

*1 Refrigerant leakage contributes to climate change. Refrigerant with lower global warming potential (GWP) would contribute less to global warming than a refrigerant with higher GWP, if leaked to the atmosphere. This appliance contains a refrigerant fluid with a GWP equal to 550. This means that if 1 kg of this refrigerant fluid would be leaked to the atmosphere, the impact on global warming would be 550 times higher than 1 kg of CO₂, over a period of 100 years. Never try to interfere with the refrigerant circuit yourself or disassemble the product yourself and always ask a professional. The GWP of R32 is 675 in the IPCC 4th Assessment Report.

*2 Energy consumption based on standard test results. Actual energy consumption will depend on how the appliance is used and where it is located.

*3 Optional air protection guide is required where ambient temperature is lower than -5°C.

*4 SEER and SCOP are based on 2009/125/EC:Energy-related Products Directive and Regulation(EU) No206/2012.

*5 Joint pipe is required depending on installed refrigerant pipes, outdoor units and indoor units.

SERIES SELECTION

Power Inverter Series



Indoor Unit

R32
R410A



PCA-M35/50/60/71/100/125/140KA2

Outdoor Unit

R410A

For Single



PUHZ-ZRP35/50 PUHZ-ZRP60/71 PUHZ-ZRP100/125/140

R410A

For Multi
(Twin/Triple/Quadruple)



PUHZ-ZRP100/125/140/200/250

Remote Controller



Optional



Optional



Optional



Optional



Optional*

* PAR-SA9CA is also required.

PCA-M KA Indoor Unit Combinations Indoor unit combinations shown below are possible.

Indoor Unit Combination	Outdoor Unit Capacity																			
	For Single									For Twin					For Triple			For Quadruple		
	35	50	60	71	100	125	140	200	250	71	100	125	140	200	250	140	200	250	200	250
Power Inverter (PUHZ-ZRP)	35x1	50x1	60x1	71x1	100x1	125x1	140x1	-	-	35x2	50x2	60x2	71x2	100x2	125x2	50x3	60x3	71x3	50x4	60x4
Distribution Pipe	-	-	-	-	-	-	-	-	-	MSDD-50TR-E			MSDD-50WR-E		MSDT-111R-E			MSDF-1111R-E		

SERIES SELECTION

Standard Inverter Series



Indoor Unit

R32
R410A



PCA-M35/50/60/71/100/125/140KA2

Outdoor Unit

R410A

For Single



SUZ-KA35 SUZ-KA50/60/71 PUHZ-P100/125/140

R410A

For Multi
(Twin/Triple/Quadruple)



PUHZ-P100/125/140 PUHZ-P200/250

Remote Controller



Optional



Optional



Optional



Optional



Optional*

* PAR-SA9CA is also required.

PCA-M KA Indoor Unit Combinations Indoor unit combinations shown below are possible.

Indoor Unit Combination	Outdoor Unit Capacity																			
	For Single									For Twin					For Triple			For Quadruple		
	35	50	60	71	100	125	140	200	250	71	100	125	140	200	250	140	200	250	200	250
Standard Inverter (PUHZ-P&SUZ)	35x1	50x1	60x1	71x1	100x1	125x1	140x1	-	-	50x2	60x2	71x2	100x2	125x2	50x3	60x3	71x3	50x4	60x4	
Distribution Pipe	-	-	-	-	-	-	-	-	-	MSDD-50TR-E			MSDD-50WR-E		MSDT-111R-E			MSDF-1111R-E		

R32
R410A

PCA-HA SERIES

PCA-M71HA2



Standard features include a strong carbon-black stainless steel body and built-in oil mist filter to prevent oil from getting into the unit providing a comfortable air conditioning environment in kitchens that use open-flame cooking.

Tough on Oily Smoke

A durable stainless steel casing that is resistant to oil and grease is provided to protect the surface of the body. Grimy dirt and stains are removed easily, enabling the unit to be kept clean at all times.

High-performance Oil Mist Filter

A high-performance heavy-duty oil mist filter is included as standard equipment. The filtering system is more efficient than conventional filters, thereby effectively reducing the oily smoke entering the air conditioner. The filter is disposable, thereby enabling trouble-free cleaning and maintenance.

Oil Mist Filter Cleaning

When used in kitchens, the oil mist filter should be replaced once every two months. The system comes with 12 filter elements. After these have been used, optional elements (PAC-SG38KF-E) can be purchased.



Oil mist filter

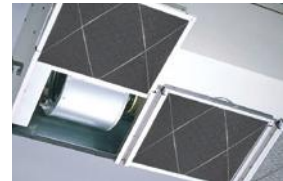

Pull the handle to easily slide the filter out

Easy Maintenance – Even for Cleaning the Fan

A separate fan casing that can be disassembled in sections is adopted to ensure easy fan cleaning. Drain pan cleaning onsite is also no problem owing to the use of a pipe connector that is easily removed.



Cosmetic Front and Hanging Fixture Covers (Option)

Cosmetic covers are available to prevent the collection of dust and grime on the main body and hanging fixture sections.

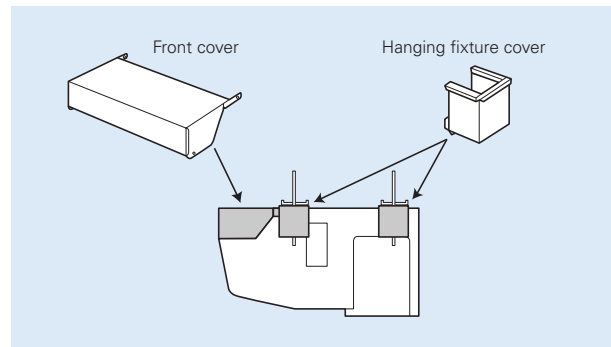

Fresh Outside-air Intake (Option)

There is a knock-out opening on the rear panel of the unit that can be used to bring fresh air into the unit. This helps to improve ventilation and make the kitchen comfortable.

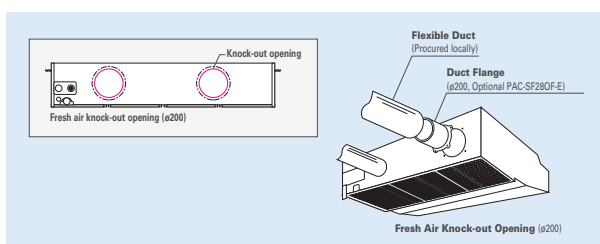

- Notes: 1) A fresh-air duct flange is required (sold separately)
2) Intake air is not 100% fresh (outside) air.

SERIES SELECTION

Power Inverter Series



Indoor Unit

R32
R410A



PCA-M71HA2

Outdoor Unit

R32

For Single



PUZ-ZM71

R32

For Multi
(Twin/Triple)



PUZ-ZM140/250

Remote Controller



Optional



Optional



Optional



Optional*

* PAR-SA9CA is also required.

PCA-M HA Indoor Unit Combinations Indoor unit combinations shown below are possible.

Indoor Unit Combination	Outdoor Unit Capacity																			
	For Single									For Twin					For Triple			For Quadruple		
	35	50	60	71	100	125	140	200	250	71	100	125	140	200	250	140	200	250	200	250
Power Inverter (PUZ-ZM)	-	-	-	71x1	-	-	-	-	-	-	-	-	71x2	-	-	-	-	71x3	-	-
Distribution Pipe	-	-	-	-	-	-	-	-	-	-	-	-	MSDD-60TR2-E	-	-	-	-	MSDT-111R3-E	-	-

SERIES SELECTION

Power Inverter Series



Indoor Unit

R32
R410A



PCA-M71HA2

Outdoor Unit

R410A

For Single



PUHZ-ZRP71

R410A

For Multi
(Twin/Triple)



PUHZ-ZRP140/250

Remote Controller



Optional



Optional



Optional



Optional*

* PAR-SA9CA is also required.

PCA-M HA Indoor Unit Combinations Indoor unit combinations shown below are possible.

Indoor Unit Combination	Outdoor Unit Capacity																			
	For Single									For Twin					For Triple			For Quadruple		
	35	50	60	71	100	125	140	200	250	71	100	125	140	200	250	140	200	250	200	250
Power Inverter (PUHZ-ZRP)	-	-	-	71x1	-	-	-	-	-	-	-	-	71x2	-	-	-	-	71x3	-	-
Distribution Pipe	-	-	-	-	-	-	-	-	-	-	-	-	MSDD-60TR-E	-	-	-	-	MSDT-111R-E	-	-

PCA-RP HA SERIES

POWER INVERTER

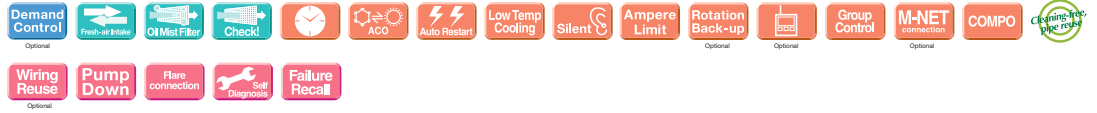

Type			Inverter Heat Pump		
Indoor Unit			PCA-M71HA2		
Outdoor Unit			PUZ-ZM71VHA2		
Refrigerant ^{*1)}			R32		
Power Supply	Source		Outdoor power supply		
	Outdoor(V/Phase/Hz)		230/Single/50		
Cooling	Capacity	Rated	kW	7.1	
		Min-Max	kW	3.3 - 8.1	
	Total Input	Rated	kW	2.028	
	EER			3.50	
	Design load		kW	7.1	
	Annual electricity consumption ^(*)2)		kWh/a	443	
SEER ^(*)4)				5.6	
		Energy efficiency class		A+	
Heating	Capacity	Rated	kW	7.6	
		Min-Max	kW	3.5 - 10.2	
	Total Input	Rated	kW	2.171	
	COP			3.50	
	Design load		kW	4.7	
	Declared Capacity	at reference design temperature	kW	4.7 (-10°C)	
		at bivalent temperature	kW	4.7 (-10°C)	
		at operation limit temperature	kW	3.4 (-20°C)	
	Back up heating capacity		kW	0.0	
	Annual electricity consumption ^(*)2)		kWh/a	1684	
SCOP ^(*)4)			3.9		
		Energy efficiency class		A	
Operating Current(Max)			A	19.4	
Indoor Unit	Input [cooling / Heating]	Rated	kW	0.10 / 0.10	
			A	0.43	
	Operating Current(Max)		A	0.43	
	Dimensions	H*W*D	mm	280-1136-650	
	Weight		kg	42	
	Air Volume (Lo-Mi2-Mi1-Hi)		m³/min	16-18	
	Sound Level (Lo-Mi2-Mi1-Hi) (SPL)		dB(A)	37-39	
Sound Level (PWL)		dB(A)	57		
Outdoor Unit	Dimensions	H*W*D	mm	943-950-330(+25)	
			kg	67	
	Air Volume	Cooling	m³/min	55	
		Heating	m³/min	55	
	Sound Level (SPL)	Cooling	dB(A)	47	
		Heating	dB(A)	49	
	Sound Level (PWL)	Cooling	dB(A)	67	
		Heating	dB(A)	67	
	Operating Current(Max)		A	19	
	Breaker Size		A	25	
Ext.Piping	Diameter ^(*)3)	Liquid/Gas	mm	9.52 / 15.88	
	Max.Length	Out-In	m	55	
	Max.Height	Out-In	m	30	
Guaranteed Operating Range (Outdoor)			Cooling ^(*)3)	°C	
			Heating	°C	
				-15 ~ +46	
				-20 ~ +21	

*1 Refrigerant leakage contributes to climate change. Refrigerant with lower global warming potential (GWP) would contribute less to global warming than a refrigerant with higher GWP if leaked to the atmosphere. This appliance contains a refrigerant fluid with a GWP equal to 1975. This means that if 1 kg of this refrigerant fluid would be leaked to the atmosphere, the impact on global warming would be 1975 times higher than 1 kg of CO₂, over a period of 100 years. Never try to interfere with the refrigerant circuit yourself or disassemble the product yourself and always ask a professional. The GWP of R410A is 2088 in the IPCC 4th Assessment Report.

*2 Energy consumption based on standard test results. Actual energy consumption will depend on how the appliance is used and where it is located.

*3 Optional air protection guide is required where ambient temperature is lower than -5°C.

*4 SEER and SCOP are based on 2009/125/EC:Energy-related Products Directive and Regulation(EU) No206/2012.

*5 Joint pipe is required depending on installed refrigerant pipes, outdoor units and indoor units.

PCA-RP HA SERIES

POWER INVERTER

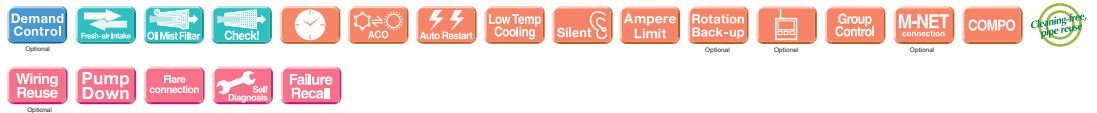

Type			Inverter Heat Pump		
Indoor Unit			PCA-M71HA2		
Outdoor Unit			PUHZ-ZRP71VHA2		
Refrigerant ^{*1)}			R410A		
Power Supply	Source		Outdoor power supply		
	Outdoor(V/Phase/Hz)		230/Single/50		
Cooling	Capacity	Rated	kW	7.1	
		Min-Max	kW	3.3 - 8.1	
	Total Input	Rated	kW	2.170	
	EER			3.27	
	Design load		kW	7.1	
	Annual electricity consumption ^(*)2)		kWh/a	444	
SEER ^(*)4)				5.6	
		Energy efficiency class		A+	
Heating	Capacity	Rated	kW	7.6	
		Min-Max	kW	3.5 - 10.2	
	Total Input	Rated	kW	2.350	
	COP			3.23	
	Design load		kW	4.7	
	Declared Capacity	at reference design temperature	kW	4.7 (-10°C)	
		at bivalent temperature	kW	4.7 (-10°C)	
		at operation limit temperature	kW	3.5 (-20°C)	
	Back up heating capacity		kW	0.0	
	Annual electricity consumption ^(*)2)		kWh/a	1724	
SCOP ^(*)4)			3.8		
		Energy efficiency class		A	
Operating Current(Max)			A	19.4	
Indoor Unit	Input [cooling / Heating]	Rated	kW	0.10 / 0.10	
			A	0.43	
	Operating Current(Max)		A	0.43	
	Dimensions	H*W*D	mm	280-1136-650	
	Weight		kg	42	
	Air Volume (Lo-Mi2-Mi1-Hi)		m³/min	16-18	
	Sound Level (Lo-Mi2-Mi1-Hi) (SPL)		dB(A)	37-39	
Sound Level (PWL)		dB(A)	57		
Outdoor Unit	Dimensions	H*W*D	mm	943-950-330(+30)	
			kg	70	
	Air Volume	Cooling	m³/min	55	
		Heating	m³/min	55	
	Sound Level (SPL)	Cooling	dB(A)	47	
		Heating	dB(A)	48	
	Sound Level (PWL)	Cooling	dB(A)	67	
		Heating	dB(A)	67	
	Operating Current(Max)		A	19	
	Breaker Size		A	25	
Ext.Piping	Diameter ^(*)3)	Liquid/Gas	mm	9.52 / 15.88	
	Max.Length	Out-In	m	50	
	Max.Height	Out-In	m	30	
Guaranteed Operating Range (Outdoor)			Cooling ^(*)3)	°C	
			Heating	°C	
				-15 ~ +46	
				-20 ~ +21	

*1 Refrigerant leakage contributes to climate change. Refrigerant with lower global warming potential (GWP) would contribute less to global warming than a refrigerant with higher GWP if leaked to the atmosphere. This appliance contains a refrigerant fluid with a GWP equal to 1975. This means that if 1 kg of this refrigerant fluid would be leaked to the atmosphere, the impact on global warming would be 1975 times higher than 1 kg of CO₂, over a period of 100 years. Never try to interfere with the refrigerant circuit yourself or disassemble the product yourself and always ask a professional. The GWP of R410A is 2088 in the IPCC 4th Assessment Report.

*2 Energy consumption based on standard test results. Actual energy consumption will depend on how the appliance is used and where it is located.

*3 Optional air protection guide is required where ambient temperature is lower than -5°C.

*4 SEER and SCOP are based on 2009/125/EC:Energy-related Products Directive and Regulation(EU) No206/2012.

*5 Joint pipe is required depending on installed refrigerant pipes, outdoor units and indoor units.

PSA SERIES

PSA-M71/100/125/140KA

R32
R410A



Installation of this floor-standing series is easy and quick.
An excellent choice when there is a sudden need for an air conditioner to be installed.

A slim design that fits neatly into any space

With a width of only 600mm, this slim unit can fit neatly into narrow spaces.



Built-in MA smart remote controller

The large and easy-to-read LCD makes it easy to perform a variety of functions.



Equipped with a long-life filter as standard

The adoption of a grille that can be opened allows the filter to be easily removed.

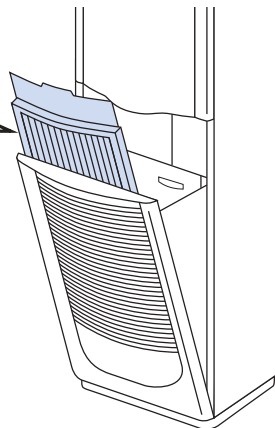

A wide airflow range with horizontal swinging

The horizontal swinging function can be turned on or off via the remote controller to deliver comfort over a wider area.

Automatic swinging in the horizontal direction

The horizontal-swinging louvers provide wide coverage for improved comfort.

Airflow can also be adjusted manually in the vertical direction.

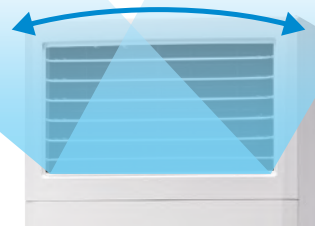

Floor-standing Line-up

The PSA series was previously only able to be connected to P series outdoor units. However, it can now also be connected to S series outdoor units. This wider lineup provides our customers with a more flexible range of options.

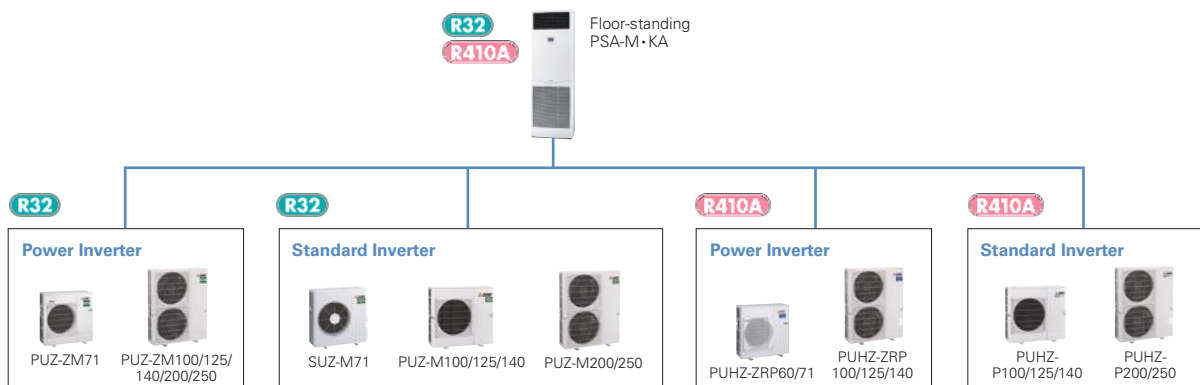

SERIES SELECTION

Power Inverter Series



Indoor Unit

R32
R410A



PSA-M71/100/125/140KA

Outdoor Unit

R32

For Single



PUZ-ZM71



PUZ-ZM100/125/140

R32

For Multi
(Twin/Triple)



PUZ-ZM140/200/250

Remote Controller



Built-in



Optional*

* PAR-SA9CA-E is also required.

PSA-M Indoor Unit Combinations Indoor unit combinations shown below are possible.

Indoor Unit Combination	Outdoor Unit Capacity																			
	For Single										For Twin					For Triple			For Quadruple	
	35	50	60	71	100	125	140	200	250	71	100	125	140	200	250	140	200	250	200	250
Power Inverter (PUZ-ZM)	-	-	-	71x1	100x1	125x1	140x1	-	-	-	-	-	71x2	100x2	125x2	-	-	71x3	-	-
Distribution Pipe	-	-	-	-	-	-	-	-	-	-	-	-	MSDD-50TR2-E	MSDD-50WR2-E	-	-	MSDT-111R3-E	-	-	

SERIES SELECTION

Standard Inverter Series



Indoor Unit

R32
R410A



PSA-M71/100/125/140KA

Outdoor Unit

R32

For Single



SUZ-M71



PUZ-M100/125/140

R32

For Multi
(Twin/Triple)



PUZ-M140



PUZ-M200/250

Remote Controller



Built-in



Optional*

* PAR-SA9CA-E is also required.

PSA-M Indoor Unit Combinations Indoor unit combinations shown below are possible.

Indoor Unit Combination	Outdoor Unit Capacity																			
	For Single										For Twin					For Triple			For Quadruple	
	35	50	60	71	100	125	140	200	250	71	100	125	140	200	250	140	200	250	200	250
Standard Inverter (PUZ-M)	-	-	-	71x1	100x1	125x1	140x1	-	-	-	-	-	71x2	100x2	125x2	-	-	71x3	-	-
Distribution Pipe	-	-	-	-	-	-	-	-	-	-	-	-	MSDD-50TR2-E	MSDD-50WR2-E	-	-	MSDT-111R3-E	-	-	

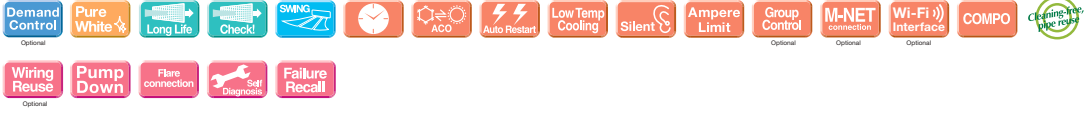

PSA-M SERIES
POWER INVERTER



Type		Inverter Heat Pump								
Indoor Unit		PSA-M71KA	PSA-M100KA	PSA-M100KA	PSA-M125KA	PSA-M125KA	PSA-M140KA	PSA-M140KA		
Outdoor Unit		PUZ-ZM71VHA2	PUZ-ZM100VKA2	PUZ-ZM100VKA2	PUZ-ZM125VKA2	PUZ-ZM125VKA2	PUZ-ZM140VKA2	PUZ-ZM140VKA2		
Refrigerant ⁽¹⁾		R32								
Power Source		Outdoor power supply								
Supply Outdoor(V/Phase/Hz)		VKA·VHA:230/Single/50, YKA:400/Three/50								
Cooling	Capacity	Rated	kW	7.1	9.5	9.5	12.5	12.5	13.4	13.4
		Min-Max	kW	3.3 - 8.1	4.9 - 11.4	4.9 - 11.4	5.5 - 14.0	5.5 - 14.0	6.2 - 15.0	6.2 - 15.0
	Total Input	Rated	kW	1.888	2.493	2.493	3.955	3.955	3.976	3.976
	EER	Rated		3.76	3.81	3.81	3.16	3.16	3.37	3.37
	Design load		kW	7.1	9.5	9.5	—	—	—	—
Heating	Capacity	Rated	kW	7.6	11.2	11.2	14.0	14.0	16.0	16.0
		Min-Max	kW	3.5 - 10.2	4.5 - 14.0	4.5 - 14.0	5 - 16.0	5 - 16.0	5.7 - 18.0	5.7 - 18.0
	Total Input	Rated	kW	2.338	3.172	3.172	4.501	4.501	5.000	5.000
	COP	Rated		3.25	3.53	3.53	3.11	3.11	3.20	3.20
	Design load		kW	4.7	7.8	7.8	—	—	—	—
Operating Current(Max)	Input [cooling / Heating]	Rated	kW	0.06 / 0.06	0.11 / 0.11	0.11 / 0.11	0.11 / 0.11	0.11 / 0.11	0.11 / 0.11	0.11 / 0.11
	Operating Current(Max)		A	0.4	0.71	0.71	0.73	0.73	0.73	0.73
	Dimensions	H*W*D	mm	1900-600-360	1900-600-360	1900-600-360	1900-600-360	1900-600-360	1900-600-360	1900-600-360
	Weight		kg	46	46	46	46	46	48	48
	Air Volume (Lo-Mi2-Mi1-Hi)		m³/min	20-22-24	25-28-30	25-28-30	25-28-31	25-28-31	25-28-31	25-28-31
Outdoor Unit	Dimensions	H*W*D	mm	943-950-330(+25)	1338-1050-330(+40)	1338-1050-330(+40)	1338-1050-330(+40)	1338-1050-330(+40)	1338-1050-330(+40)	1338-1050-330(+40)
	Weight		kg	67	105	111	114	114	105	118
	Air Volume	Cooling	m³/min	55	110	110	120	120	120	120
		Heating	m³/min	55	110	110	120	120	120	120
	Sound Level (SPL)	Cooling	dB(A)	47	49	49	50	50	50	50
Guaranteed Operating Range (Outdoor)	Cooling ⁽³⁾	°C	-15 ~ +46	-15 ~ +46	-15 ~ +46	-15 ~ +46	-15 ~ +46	-15 ~ +46	-15 ~ +46	-15 ~ +46
	Heating	°C	-20 ~ +21	-20 ~ +21	-20 ~ +21	-20 ~ +21	-20 ~ +21	-20 ~ +21	-20 ~ +21	-20 ~ +21

*1 Refrigerant leakage contributes to climate change. Refrigerant with lower global warming potential (GWP) would contribute less to global warming than a refrigerant with higher GWP if leaked to the atmosphere. This appliance contains a refrigerant fluid with a GWP equal to 1975. This means that if 1 kg of this refrigerant fluid would be leaked to the atmosphere, the impact on global warming would be 1975 times higher than 1 kg of CO₂ over a period of 100 years. Never try to interfere with the refrigerant circuit yourself or disassemble the product yourself and always ask a professional. The GWP of R410A is 2088 in the IPCC 4th Assessment Report.
 *2 Energy consumption based on standard test results. Actual energy consumption will depend on how the appliance is used and where it is located.
 *3 Optional air protection guide is required where ambient temperature is lower than -5°C. *4 SEER and SCOP are based on 2009/125/EC Energy-related Products Directive and Regulation(EU) No206/2012.

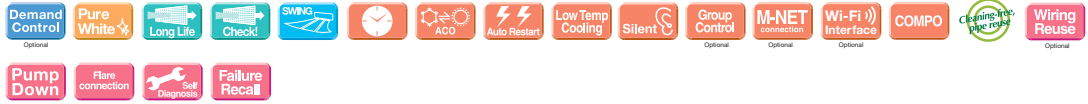

PSA-M SERIES
STANDARD INVERTER



Type		Inverter Heat Pump								
Indoor Unit		PSA-M71KA	PSA-M100KA	PSA-M100KA	PSA-M125KA	PSA-M125KA	PSA-M140KA	PSA-M140KA		
Outdoor Unit		SUZ-M71VA	PUZ-M100VKA2	PUZ-M100VKA2	PUZ-M125VKA2	PUZ-M125VKA2	PUZ-M140VKA2	PUZ-M140VKA2		
Refrigerant ⁽¹⁾		R32								
Power Source		Outdoor power supply								
Supply Outdoor(V/Phase/Hz)		VA, VKA:230/Single/50, YKA:400/Three/50								
Cooling	Capacity	Rated	kW	7.1	9.4	9.4	12.1	12.1	13.6	13.6
		Min-Max	kW	2.2 - 8.1	3.7 - 10.6	3.7 - 10.6	5.6 - 13.0	5.6 - 13.0	5.8 - 13.7	5.8 - 13.7
	Total Input	Rated	kW	1.972	2.686	2.686	4.481	4.481	5.037	5.037
	EER	Rated		3.60	3.50	3.50	2.70	2.70	2.70	2.70
	Design load		kW	7.1	9.4	9.4	—	—	—	—
Heating	Capacity	Rated	kW	8.0	11.2	11.2	13.5	13.5	15.0	15.0
		Min-Max	kW	2.1 - 10.2	2.8 - 12.5	2.8 - 12.5	4.8 - 15.0	4.8 - 15.0	4.9 - 15.8	4.9 - 15.8
	Total Input	Rated	kW	2.492	3.246	3.246	4.355	4.355	4.761	4.761
	COP	Rated		3.21	3.45	3.45	3.10	3.10	3.15	3.15
	Design load		kW	5.8	8.0	8.0	—	—	—	—
Operating Current(Max)	Input [cooling / Heating]	Rated	kW	0.06 / 0.06	0.11 / 0.11	0.11 / 0.11	0.11 / 0.11	0.11 / 0.11	0.11 / 0.11	0.11 / 0.11
	Operating Current(Max)		A	0.4	0.71	0.71	0.73	0.73	0.73	0.73
	Dimensions	H*W*D	mm	1900-600-360	1900-600-360	1900-600-360	1900-600-360	1900-600-360	1900-600-360	1900-600-360
	Weight		kg	46	46	46	46	46	48	48
	Air Volume (Lo-Mi2-Mi1-Hi)		m³/min	20-22-24	25-28-30	25-28-30	25-28-31	25-28-31	25-28-31	25-28-31
Outdoor Unit	Dimensions	H*W*D	mm	880-840-330	981-1050-330(+40)	981-1050-330(+40)	981-1050-330(+40)	981-1050-330(+40)	981-1050-330(+40)	981-1050-330(+40)
	Weight		kg	55	76	78	84	85	84	85
	Air Volume	Cooling	m³/min	50.1	79	79	86	86	86	86
		Heating	m³/min	50.1	79	79	92	92	92	92
	Sound Level (SPL)	Cooling	dB(A)	49	51	51	54	54	55	55
Guaranteed Operating Range (Outdoor)	Cooling ⁽³⁾	°C	-15 ~ +46	-15 ~ +46	-15 ~ +46	-15 ~ +46	-15 ~ +46	-15 ~ +46	-15 ~ +46	-15 ~ +46
	Heating	°C	-10 ~ +24	-15 ~ +21	-15 ~ +21	-15 ~ +21	-15 ~ +21	-15 ~ +21	-15 ~ +21	-15 ~ +21

*1 Refrigerant leakage contributes to climate change. Refrigerant with lower global warming potential (GWP) would contribute less to global warming than a refrigerant with higher GWP if leaked to the atmosphere. This appliance contains a refrigerant fluid with a GWP equal to 1975. This means that if 1 kg of this refrigerant fluid would be leaked to the atmosphere, the impact on global warming would be 1975 times higher than 1 kg of CO₂ over a period of 100 years. Never try to interfere with the refrigerant circuit yourself or disassemble the product yourself and always ask a professional. The GWP of R410A is 2088 in the IPCC 4th Assessment Report.
 *2 Energy consumption based on standard test results. Actual energy consumption will depend on how the appliance is used and where it is located.
 *3 Optional air protection guide is required where ambient temperature is lower than -5°C.
 *4 SEER and SCOP are based on 2009/125/EC Energy-related Products Directive and Regulation(EU) No206/2012.
 *5 Joint pipe is required depending on installed refrigerant pipes, outdoor units and indoor units.

SERIES SELECTION

Power Inverter Series



Indoor Unit

R32
R410A



PSA-M71/100/125/140KA

Outdoor Unit

R410A

For Single



PUHZ-ZRP71



PUHZ-ZRP100/125/140

R410A

For Multi
(Twin/Triple)



PUHZ-ZRP140/200/250

Remote Controller



Built-in



Optional*

* PAR-SA9CA-E is also required.

PSA-M Indoor Unit Combinations Indoor unit combinations shown below are possible.

Indoor Unit Combination	Outdoor Unit Capacity																				
	For Single									For Twin					For Triple			For Quadruple			
	35	50	60	71	100	125	140	200	250	71	100	125	140	200	250	140	200	250	200	250	
Power Inverter (PUHZ-ZRP)	-	-	-	71x1	100x1	125x1	140x1	-	-	-	-	-	-	71x2	100x2	125x2	-	-	71x3	-	-
Distribution Pipe	-	-	-	-	-	-	-	-	-	-	-	-	-	MSDD-50TR-E	MSDD-50WR-E	-	-	MSDT-111R-E	-	-	

SERIES SELECTION

Standard Inverter Series



Indoor Unit

R32
R410A



PSA-M71/100/125/140KA

Outdoor Unit

R410A

For Single



PUHZ-P100/125/140

R410A

For Multi
(Twin/Triple)



PUHZ-P140



PUHZ-P200/250

Remote Controller



Built-in



Optional*

* PAR-SA9CA-E is also required.

PSA-M Indoor Unit Combinations Indoor unit combinations shown below are possible.

Indoor Unit Combination	Outdoor Unit Capacity																				
	For Single									For Twin					For Triple			For Quadruple			
	35	50	60	71	100	125	140	200	250	71	100	125	140	200	250	140	200	250	200	250	
Standard Inverter (PUHZ-P)	-	-	-	-	100x1	125x1	140x1	-	-	-	-	-	-	71x2	100x2	125x2	-	-	71x3	-	-
Distribution Pipe	-	-	-	-	-	-	-	-	-	-	-	-	-	MSDD-50TR-E	MSDD-50WR-E	-	-	MSDT-111R-E	-	-	

PSA-RR SERIES

POWER INVERTER

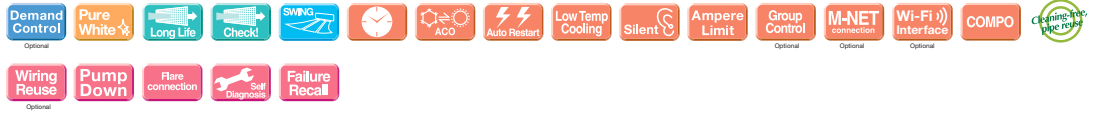

Type		Inverter Heat Pump								
Indoor Unit		PSA-M71KA	PSA-M100KA	PSA-M100KA	PSA-M125KA	PSA-M125KA	PSA-M140KA	PSA-M140KA		
Outdoor Unit		PUHZ-ZRP71VHA2 PUHZ-ZRP100VKA3 PUHZ-ZRP100YKA3 PUHZ-ZRP125VKA3 PUHZ-ZRP125YKA3 PUHZ-ZRP140VKA3 PUHZ-ZRP140YKA3								
Refrigerant ⁽¹⁾		R410A								
Power Supply		Outdoor power supply								
Outdoor(V/Phase/Hz)		VKA-VHA:230/Single/50, YKA:400/Three/50								
Cooling	Capacity	Rated	7.1	9.5	9.5	12.5	12.5	13.4	13.4	
		Min-Max	3.3 - 8.1	4.9 - 11.4	4.9 - 11.4	5.5 - 14.0	5.5 - 14.0	6.2 - 15.0	6.2 - 15.0	
	Total Input	Rated	1.890	2.500	2.500	4.084	4.084	4.060	4.060	
	EER		3.76	3.80	3.80	3.06	3.06	3.30	3.30	
	Design load	kW	7.1	9.5	9.5	—	—	—	—	
	Annual electricity consumption ⁽²⁾	kWh/a	394	584	595	—	—	—	—	
	SEER ⁽⁴⁾	6.3	5.6	5.5	—	—	—	—		
		Energy efficiency class	A++	A+	A	—	—	—	—	
Heating	Capacity	Rated	7.6	11.2	11.2	14.0	14.0	16.0	16.0	
		Min-Max	3.5 - 10.2	4.5 - 14.0	4.5 - 14.0	5.0 - 16.0	5.0 - 16.0	5.7 - 18.0	5.7 - 18.0	
	Total Input	Rated	2.210	3.080	3.080	4.242	4.242	4.790	4.790	
	COP		3.44	3.64	3.64	3.30	3.30	3.34	3.34	
	Design load	kW	4.7	7.8	7.8	—	—	—	—	
	Declared Capacity	at reference design temperature	kW	4.7 (-10°C)	7.8 (-10°C)	7.8 (-10°C)	—	—	—	—
		at bivalent temperature	kW	4.7 (-10°C)	7.8 (-10°C)	7.8 (-10°C)	—	—	—	—
		at operation limit temperature	kW	3.5 (-20°C)	5.8 (-20°C)	5.8 (-20°C)	—	—	—	—
	Back up heating capacity	kW	0.0	0.0	0.0	—	—	—	—	
	Annual electricity consumption ⁽²⁾	kWh/a	1668	2730	2731	—	—	—	—	
		SCOP ⁽⁴⁾	3.9	3.9	3.9	—	—	—	—	
		Energy efficiency class	A	A	A	—	—	—	—	
Operating Current(Max)	A	19.4	27.2	27.2	27.2	27.2	28.7	28.7		
Indoor Unit	Input [cooling / Heating]	Rated	0.06 / 0.06	0.11 / 0.11	0.11 / 0.11	0.11 / 0.11	0.11 / 0.11	0.11 / 0.11	0.11 / 0.11	
	Operating Current(Max)	A	0.4	0.71	0.71	0.73	0.73	0.73	0.73	
	Dimensions	H*W*D	1900-600-360	1900-600-360	1900-600-360	1900-600-360	1900-600-360	1900-600-360	1900-600-360	
	Weight	kg	46	46	46	46	46	48	48	
	Air Volume (Lo-Mi2-Mi1-Hi)	m ³ /min	20-22-24	25-28-30	25-28-30	25-28-31	25-28-31	25-28-31	25-28-31	
	Sound Level (Lo-Mi2-Mi1-Hi) (SPL)	dB(A)	40-42-44	45-49-51	45-49-51	45-49-51	45-49-51	45-49-51	45-49-51	
	Sound Level (PWL)	dB(A)	60	65	65	66	66	66	66	
	Outdoor Unit	Dimensions	H*W*D	943-950-330(+30)	1338-1050-330(+40)	1338-1050-330(+40)	1338-1050-330(+40)	1338-1050-330(+40)	1338-1050-330(+40)	
		Weight	kg	70	116	123	116	125	118	131
		Air Volume	Cooling	m ³ /min	55	110	110	120	120	120
	Heating	m ³ /min	55	110	110	120	120	120		
Sound Level (SPL)	Cooling	dB(A)	47	49	49	50	50	50	50	
	Heating	dB(A)	48	51	51	52	52	52	52	
Sound Level (PWL)	Cooling	dB(A)	67	69	69	70	70	70	70	
	Heating	dB(A)	67	69	69	70	70	70	70	
Operating Current(Max)	A	19	26.5	8	26.5	9.5	28	13		
Breaker Size	A	25	32	16	32	16	40	16		
Ext.Piping	Diameter ⁽⁵⁾	Liquid/Gas	mm	9.52 / 15.88	9.52 / 15.88	9.52 / 15.88	9.52 / 15.88	9.52 / 15.88	9.52 / 15.88	
	Max.Length	Out-In	m	50	75	75	75	75	75	
	Max.Height	Out-In	m	30	30	30	30	30	30	
Guaranteed Operating Range (Outdoor)	Cooling ⁽³⁾	°C	-15 ~ +46	-15 ~ +46	-15 ~ +46	-15 ~ +46	-15 ~ +46	-15 ~ +46	-15 ~ +46	
	Heating	°C	-20 ~ +21	-20 ~ +21	-20 ~ +21	-20 ~ +21	-20 ~ +21	-20 ~ +21	-20 ~ +21	

*1 Refrigerant leakage contributes to climate change. Refrigerant with lower global warming potential (GWP) would contribute less to global warming than a refrigerant with higher GWP if leaked to the atmosphere. This appliance contains a refrigerant fluid with a GWP equal to 1975. This means that if 1 kg of this refrigerant fluid would be leaked to the atmosphere, the impact on global warming would be 1975 times higher than 1 kg of CO₂ over a period of 100 years. Never try to interfere with the refrigerant circuit yourself or disassemble the product yourself and always ask a professional. The GWP of R410A is 2088 in the IPCC 4th Assessment Report.
 *2 Energy consumption based on standard test results. Actual energy consumption will depend on how the appliance is used and where it is located.
 *3 Optional air protection guide is required where ambient temperature is lower than -5°C.
 *4 SEER and SCOP are based on 2009/125/EC:Energy-related Products Directive and Regulation(EU) No206/2012. *5 Joint pipe is required depending on installed refrigerant pipes, outdoor units and indoor units.

PSA-RR SERIES

STANDARD INVERTER

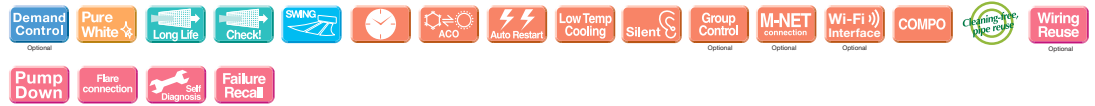

Type		Inverter Heat Pump							
Indoor Unit		PSA-M100KA	PSA-M100KA	PSA-M125KA	PSA-M125KA	PSA-M140KA	PSA-M140KA		
Outdoor Unit		PUHZ-P100VKA PUHZ-P100YKA PUHZ-P125VKA PUHZ-P125YKA PUHZ-P140VKA PUHZ-P140YKA							
Refrigerant ⁽¹⁾		R410A							
Power Supply		Outdoor power supply							
Outdoor(V/Phase/Hz)		VKA:230/Single/50, YKA:400/Three/50							
Cooling	Capacity	Rated	9.4	9.4	12.1	12.1	13.6	13.6	
		Min-Max	3.7 - 10.6	3.7 - 10.6	5.6 - 13.0	5.6 - 13.0	5.8 - 13.7	5.8 - 13.7	
	Total Input	Rated	3.122	3.122	5.020	5.020	6.384	6.384	
	EER		3.01	3.01	2.41	2.41	2.13	2.13	
	Design load	kW	9.4	9.4	—	—	—	—	
	Annual electricity consumption ⁽²⁾	kWh/a	644	644	—	—	—	—	
	SEER ⁽⁴⁾	5.1	5.1	—	—	—	—		
		Energy efficiency class	A	A	—	—	—	—	
Heating	Capacity	Rated	11.2	11.2	13.5	13.5	15.0	15.0	
		Min-Max	2.8 - 12.5	2.8 - 12.5	4.8 - 15.0	4.8 - 15.0	4.9 - 15.8	4.9 - 15.8	
	Total Input	Rated	3.284	3.284	4.804	4.804	4.823	4.823	
	COP		3.41	3.41	2.81	2.81	3.11	3.11	
	Design load	kW	8.0	8.0	—	—	—	—	
	Declared Capacity	at reference design temperature	kW	6.0 (-10°C)	6.0 (-10°C)	—	—	—	—
		at bivalent temperature	kW	7.0 (-7°C)	7.0 (-7°C)	—	—	—	—
		at operation limit temperature	kW	4.5 (-15°C)	4.5 (-15°C)	—	—	—	—
	Back up heating capacity	kW	2.0	2.0	—	—	—	—	
	Annual electricity consumption ⁽²⁾	kWh/a	2797	2797	—	—	—	—	
		SCOP ⁽⁴⁾	4.0	4.0	—	—	—	—	
		Energy efficiency class	A+	A+	—	—	—	—	
Operating Current(Max)	A	20.7	12.2	27.2	12.2	30.7	12.2		
Indoor Unit	Input [cooling / Heating]	Rated	0.11 / 0.11	0.11 / 0.11	0.11 / 0.11	0.11 / 0.11	0.11 / 0.11	0.11 / 0.11	
	Operating Current(Max)	A	0.71	0.71	0.73	0.73	0.73	0.73	
	Dimensions	H*W*D	1900-600-360	1900-600-360	1900-600-360	1900-600-360	1900-600-360	1900-600-360	
	Weight	kg	46	46	46	46	48	48	
	Air Volume (Lo-Mi2-Mi1-Hi)	m ³ /min	25-28-30	25-28-30	25-28-31	25-28-31	25-28-31	25-28-31	
	Sound Level (Lo-Mi2-Mi1-Hi) (SPL)	dB(A)	45-49-51	45-49-51	45-49-51	45-49-51	45-49-51	45-49-51	
	Sound Level (PWL)	dB(A)	65	65	66	66	66	66	
	Outdoor Unit	Dimensions	H*W*D	981-1050-330	981-1050-330	981-1050-330	981-1050-330	981-1050-330	981-1050-330
		Weight	kg	76	78	84	85	84	85
		Air Volume	Cooling	m ³ /min	79	79	86	86	86
	Heating	m ³ /min	79	79	92	92	92		
Sound Level (SPL)	Cooling	dB(A)	51	51	54	54	56	56	
	Heating	dB(A)	54	54	56	56	57	57	
Sound Level (PWL)	Cooling	dB(A)	70	70	72	72	75	75	
	Heating	dB(A)	70	70	72	72	75	75	
Operating Current(Max)	A	20	11.5	26.5	11.5	30	11.5		
Breaker Size	A	32	16	32	16	40	16		
Ext.Piping	Diameter ⁽⁵⁾	Liquid/Gas	mm	9.52 / 15.88	9.52 / 15.88	9.52 / 15.88	9.52 / 15.88	9.52 / 15.88	
	Max.Length	Out-In	m	50	50	50	50	50	
	Max.Height	Out-In	m	30	30	30	30	30	
Guaranteed Operating Range (Outdoor)	Cooling ⁽³⁾	°C	-15 ~ +46	-15 ~ +46	-15 ~ +46	-15 ~ +46	-15 ~ +46	-15 ~ +46	
	Heating	°C	-15 ~ +21	-15 ~ +21	-15 ~ +21	-15 ~ +21	-15 ~ +21	-15 ~ +21	

*1 Refrigerant leakage contributes to climate change. Refrigerant with lower global warming potential (GWP) would contribute less to global warming than a refrigerant with higher GWP if leaked to the atmosphere. This appliance contains a refrigerant fluid with a GWP equal to 1975. This means that if 1 kg of this refrigerant fluid would be leaked to the atmosphere, the impact on global warming would be 1975 times higher than 1 kg of CO₂ over a period of 100 years. Never try to interfere with the refrigerant circuit yourself or disassemble the product yourself and always ask a professional. The GWP of R410A is 2088 in the IPCC 4th Assessment Report.
 *2 Energy consumption based on standard test results. Actual energy consumption will depend on how the appliance is used and where it is located.
 *3 Optional air protection guide is required where ambient temperature is lower than -5°C.
 *4 SEER and SCOP are based on 2009/125/EC:Energy-related Products Directive and Regulation(EU) No206/2012. *5 Joint pipe is required depending on installed refrigerant pipes, outdoor units and indoor units.

MULTI SPLIT

SERIES



SELECTION

Choose from types of indoor units and outdoor units that can run up to six indoor units each. Create the system that best matches room shapes and number of rooms.

R32 INDOOR UNITS		R32 OUTDOOR UNITS		
Wall-mounted MSZ-LN (18*25-35*50) MSZ-EF MSZ-AY25-50 MSZ-AP60VG MSZ-AP15-20 MSZ-BT	Floor-standing MFZ-KT SFZ <hr/> Ceiling-suspended PCA <hr/> Ceiling-concealed SEZ PEAD	2-port up to 2 indoor units MXZ-2F33VF4 MXZ-2F42VF4 MXZ-2F53VF(H)4 MXZ-2F53V FHZ2	3-port up to 3 indoor units MXZ-3F54VF4 MXZ-3F68VF4	4-port up to 4 indoor units MXZ-4F72VF4 MXZ-4F80VF4 MXZ-4F83VF2 MXZ-4F83V FHZ2
Cassette SLZ MLZ-KP MLZ-KY		5-port up to 5 indoor units MXZ-5F102VF2	6-port up to 6 indoor units MXZ-6F120VF2	

R410A INDOOR UNITS		R410A OUTDOOR UNITS		
Wall-mounted MSZ-LN (25-35) MSZ-FH MSZ-EF MSZ-AY25-50 MSZ-AP15-20 MSZ-SF25-50 MSZ-SF15-20 MSZ-GF	Floor-standing MFZ-KJ <hr/> Ceiling-suspended PCA <hr/> Ceiling-concealed SEZ PEAD	2-port up to 2 indoor units MXZ-2D33VA MXZ-2D42VA2 MXZ-2D53VA(H)2 MXZ-2E53VAHZ	3-port up to 3 indoor units MXZ-3E54VA MXZ-3E68VA	4-port up to 4 indoor units MXZ-4E72VA MXZ-4E83VA MXZ-4E83VAHZ
Cassette SLZ MLZ-KP PLA		5-port up to 5 indoor units MXZ-5E102VA	6-port up to 6 indoor units MXZ-6D122VA2	

CHECK SYSTEM COMPATIBILITY

Possible combinations depends on the outdoor unit chosen. Please check the following points.

Check Indoor Units

Refer to the "Indoor Unit Compatibility Table" to check if the indoor units selected can be used with the outdoor unit selected. (Indoor units not listed in the table cannot be used.)

Check Indoor Unit Capacity Combination

Refer to the "Combination Table" to check if the capacity combination of the indoor unit selected is connectable. (Combinations not listed cannot be connected.)

If the desired combination cannot be found, please change either the indoor or outdoor unit to match one of the combinations shown in the tables.

MXZ SERIES

Advancements in the MXZ Series include efficiency and flexibility in system expansion capabilities. The best solution when requiring multi-system air conditioning needs.

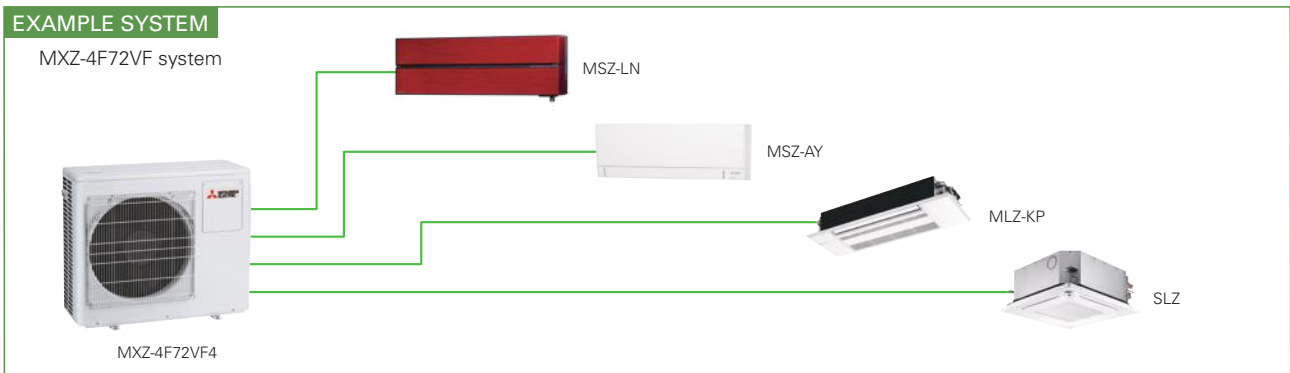
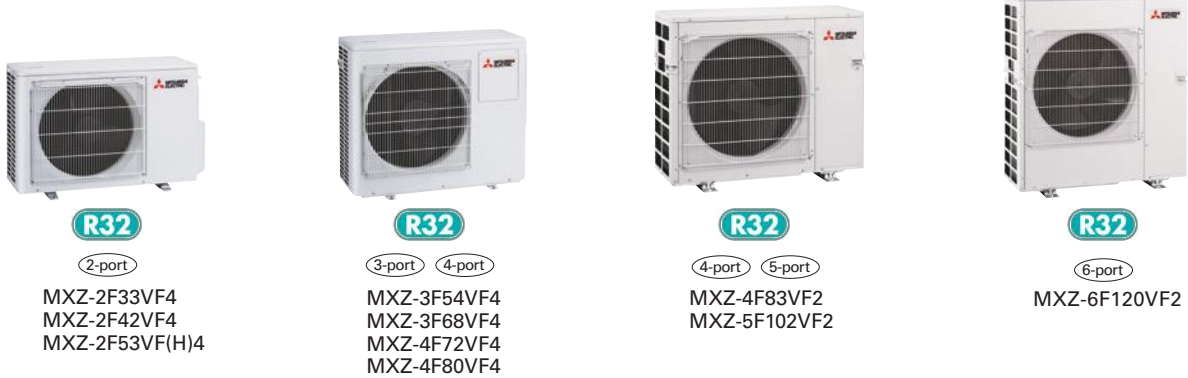

Units can be used even if it is connected to only one indoor unit (4F83/5F102/6F120)

This unit can be used even if it is connected to only one indoor unit. This offers more flexibility for wide range of application that satisfies various customers' demand.

No necessity for refrigerant charging

Depending on the pipe length and the indoor units that are connected, conventional models have required refrigerant charging, but no R32 MXZ model needs to be charged with additional refrigerant. This eliminates troublesome work at the site of installation, and reduces the amount of additional work for the installer.

Handle Up to 6 Rooms with a Single Outdoor Unit

The MXZ Series for R32 offers a ten-system line-up to choose from, ranging between 3.3 and 12.0kW. All of them are compatible with specific M, S and P series indoor units. A single outdoor unit can handle a wide range of building layouts.

Support Functions

Wiring/Piping Correction Function* (3F54/3F68/4F72/4F80/4F83/5F102/6F120)

Simply press a single button to confirm if wiring and piping are properly connected. Wiring errors are corrected automatically when discovered. This eliminates the need to confirm complicated wiring connections when expanding the system. (For details, refer to the outdoor unit installation manual.)

* Function cannot be used when the outdoor temperature is below 0°C. The correction process requires 10–20 minutes to complete and must be conducted with the unit set to the "Cooling" mode.

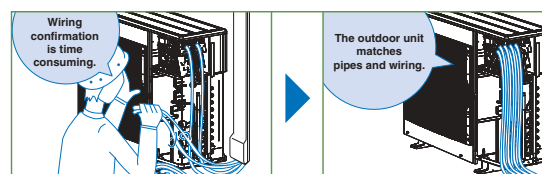

Operation Lock

To accommodate specific use applications, cooling or heating operation can be specified when setting the control board of the outdoor unit. A convenient option when a system needs to be configured for exclusive cooling or heating service. (For details, refer to the outdoor unit installation manual.)



Type (Inverter Multi - Split Heat Pump)				Up to 2 Indoor Units				Up to 3 Indoor Units		Up to 4 Indoor Units		Up to 5 Indoor Units		
Indoor Unit				Please refer to*3										
Outdoor Unit				MXZ-2F33VF4	MXZ-2F42VF4	MXZ-2F53VF4	MXZ-2F53VFH4	MXZ-3F54VF4	MXZ-3F68VF4	MXZ-4F72VF4	MXZ-4F80VF4	MXZ-4F83VF2	MXZ-5F102VF2	
Refrigerant				R32										
Power Source				Outdoor power supply										
Supply Outdoor (V/Phase/Hz)				220 - 230 - 240V / Single / 50Hz										
Cooling	Capacity	Rated	kW	3.3	4.2	5.3	5.3	5.4	6.8	7.2	8.0	8.3	10.2	
	Input	Rated	kW	0.85	0.98	1.40	1.40	1.32	1.84	1.85	2.25	1.97	2.80	
	Design Load		kW	3.3	4.2	5.3	5.3	5.4	6.8	7.2	8.0	8.3	10.2	
	Annual Electricity Consumption*1		kWh/a	189	169	216	216	222	301	311	368	342	436	
	SEER*3			6.1	8.7	8.6	8.6	8.5	7.9	8.1	7.6	8.5	8.2	
			Energy Efficiency Class*3	A++	A+++	A+++	A+++	A+++	A++	A++	A++	A+++	A++	
Heating	Capacity	Rated	kW	4.0	4.5	6.4	6.4	7.0	8.6	8.6	8.8	9.3	10.5	
	Input	Rated	kW	0.91	0.88	1.56	1.56	1.40	1.91	1.87	2.00	2.00	2.28	
	Design Load		kW	2.7	3.5	3.5	3.5	5.2	6.8	7.0	7.0	7.0	7.4	
	Declared Capacity	at reference design temperature	kW	2.2	2.7	2.7	2.7	4.2	5.7	5.6	5.6	5.8	5.9	
		at bivalent temperature	kW	2.4	2.9	2.9	2.9	4.8	6.4	6.2	6.2	6.2	6.4	
		at operation limit temperature	kW	1.6	2.3	2.3	2.1	3.2	4.6	4.8	4.8	4.9	4.9	
	Back Up Heating Capacity		kW	0.5	0.8	0.8	0.8	1.0	1.1	1.4	1.4	1.2	1.5	
	Annual Electricity Consumption*1		kWh/a	944	1065	1065	1089	1583	2321	2389	2389	2087	2205	
SCOP*3			4.0	4.6	4.6	4.5	4.6	4.1	4.1	4.1	4.7	4.6		
			Energy Efficiency Class*3	A+	A++	A++	A+	A++	A+	A+	A+	A++	A++	
Max. Operating Current (Indoor+Outdoor)				A	10.0	12.2	12.2	12.2	18.0	18.0	18.0	18.0	21.4	21.4
Outdoor Unit	Dimensions	H x W x D	mm	550 - 800 (+69) - 285 (+59.5)				710 - 840 - 330 (+66)				796 - 950 - 330		
	Weight		kg	33	37	37	38	58	58	59	59	62	62	
	Air Volume	Cooling	m ³ /min	30.8	28.4	32.7	32.7	31	35.4	35.4	40.3	57	63	
		Heating	m ³ /min	32.3	33.5	34.7	34.7	31	39.6	42.7	44.1	62	75	
	Sound Level (SPL)	Cooling	dB(A)	49	44	46	46	46	48	48	50	49	52	
		Heating	dB(A)	50	50	51	51	50	53	54	55	51	56	
	Sound Level (PWL)	Cooling	dB(A)	60	59	61	61	60	63	63	65	61	65	
Heating		dB(A)	60	59	61	61	60	63	63	65	61	65		
Breaker Size		A	15	15	15	15	25	25	25	25	25	25		
Ext. Piping	Port Diameter	Liquid	mm	6.35 x 2	6.35 x 2	6.35 x 2	6.35 x 2	6.35 x 3	6.35 x 3	6.35 x 4	6.35 x 4	6.35 x 4	6.35 x 5	
		Gas	mm	9.52 x 2	9.52 x 2	9.52 x 2	9.52 x 2	9.52 x 3	9.52 x 3	12.7 x 1+9.52 x 3	12.7 x 1+9.52 x 3	12.7 x 1+9.52 x 3	12.7 x 1+9.52 x 4	
	Total Piping Length (max)		m	20	30	30	30	50	60	60	70	80		
	Each Indoor Unit Piping Length (max)		m	15	20	20	20	25	25	25	25	25		
	Max. Height		m	10	15 (10) ²	15 (10) ²	15 (10) ²	15 (10) ²	15 (10) ²	15 (10) ²	15 (10) ²	15	15	
	Chargeless Length		m	20	30	30	30	50	60	60	60	70	80	
Guaranteed Operating Range [Outdoor]	Cooling	°C	-10 ~ +46	-10 ~ +46	-10 ~ +46	-10 ~ +46	-10 ~ +46	-10 ~ +46	-10 ~ +46	-10 ~ +46	-10 ~ +46	-10 ~ +46	-10 ~ +46	
	Heating	°C	-15 ~ +24	-15 ~ +24	-15 ~ +24	-15 ~ +24	-15 ~ +24	-15 ~ +24	-15 ~ +24	-15 ~ +24	-15 ~ +24	-15 ~ +24	-15 ~ +24	
Refrigerant/GWP			R32/675 ⁴	R32/675 ⁴	R32/675 ⁴	R32/675 ⁴	R32/675 ⁴	R32/675 ⁴	R32/675 ⁴	R32/675 ⁴	R32/675 ⁴	R32/675 ³	R32/675 ³	
Pre-Charged Quantity	Weight	kg	0.8	1.0	1.0	1.0	2.4	2.4	2.4	2.4	2.4	2.4		
	CO ₂ equivalent	t	0.54	0.68	0.68	0.68	1.62	1.62	1.62	1.62	1.62	1.62		
Max Added Quantity	Weight	kg	0.8	1.0	1.0	1.0	2.4	2.4	2.4	2.4	2.4	2.4		
	CO ₂ equivalent	t	0.54	0.68	0.68	0.68	1.62	1.62	1.62	1.62	1.62	1.62		

*1 Energy consumption based on standard test results.
 Actual energy consumption will depend on how the appliance is used and where it is located.
 *2 If the outdoor unit is installed higher than the indoor unit, max. height is reduced to 10 m.
 *3 SEER/SCOP values and energy efficiency class are measured when connected to the indoor units listed below.
 MXZ-2F33VF4 MSZ-AP15VG + MSZ-LN18VG2
 MXZ-2F42VF4 MSZ-LN18VG2 + MSZ-LN25VG2
 MXZ-2F53VF4/VFH4 MSZ-LN18VG2 + MSZ-LN35VG2
 MXZ-3F54VF4 MSZ-LN18VG2 + MSZ-LN18VG2 + MSZ-LN18VG2
 MXZ-3F68VF4 MSZ-LN18VG2 + MSZ-LN25VG2 + MSZ-LN25VG2
 MXZ-4F72VF4 MSZ-LN18VG2 + MSZ-LN18VG2 + MSZ-LN18VG2 + MSZ-LN18VG2
 MXZ-4F80VF4 MSZ-LN18VG2 + MSZ-LN18VG2 + MSZ-LN18VG2 + MSZ-LN25VG2
 MXZ-4F83VF2 MSZ-LN18VG + MSZ-LN18VG + MSZ-LN25VG + MSZ-LN25VG
 MXZ-5F102VF2 MSZ-LN18VG2 + MSZ-LN18VG2 + MSZ-LN18VG2 + MSZ-LN25VG2 + MSZ-LN25VG2
 *4 This GWP value is based on Regulation(EU) No 517/2014 from IPCC 4th edition.

Type (Inverter Multi - Split Heat Pump)				Up to 6 Indoor Units	
Indoor Unit				Please refer to*1	
Outdoor Unit				MXZ-6F120VF2	
Refrigerant				R32	
Power Source				Outdoor power supply	
Supply Outdoor (V/Phase/Hz)				220 - 230 - 240V / Single / 50Hz	
Cooling	Capacity	Rated	kW	12.0	
	Input	Rated	kW	3.60	
	EER*1			3.33	
Heating	Capacity	Rated	kW	14.0	
		Min-Max	kW	3.5 - 16.5	
	Input	Rated	kW	3.31	
	COP*1			4.23	
Operating Current (max)				A	
				29.8	
Outdoor Unit	Dimensions	H x W x D	mm	1048-950-330	
	Weight		kg	87	
	Air Volume	Cooling	m ³ /min	63	
		Heating	m ³ /min	77	
	Sound Level (SPL)	Cooling	dB(A)	55	
		Heating	dB(A)	57	
	Sound Level (PWL)	Cooling	dB(A)	69	
Heating		dB(A)	74		
Breaker Size		A	32		
Ext. Piping	Diameter	Liquid	mm	6.35 x 6	
		Gas	mm	12.7 x 1 + 9.52 x 5	
Total Piping Length (max)		m	80		
Each Indoor Unit Piping Length (max)		m	25		
Max. Height		m	15		
Chargeless Length		m	80		
Guaranteed Operating Range [Outdoor]	Cooling	°C	-10 ~ +46		
	Heating	°C	-15 ~ +24		
Refrigerant/GWP			R32/675*2		
Pre-Charged Quantity	Weight	kg	2.4		
	CO ₂ equivalent	t	1.62		
Max Added Quantity	Weight	kg	2.4		
	CO ₂ equivalent	t	1.62		

*1 EER/COP values and energy efficiency class are measured when connected to the indoor units listed below.
 MXZ-6F120VF2
 [EER/COP] MSZ-LN18VG2 + MSZ-LN18VG2 + MSZ-LN18VG2 + MSZ-LN18VG2 + MSZ-LN25VG2 + MSZ
 *2 This GWP value is based on Regulation (EU) No 517/2014 from IPCC 4th edition.

MXZ SERIES

Advancements in the MXZ Series include efficiency and flexibility in system expansion capabilities. The best solution when requiring multi-system air conditioning needs.

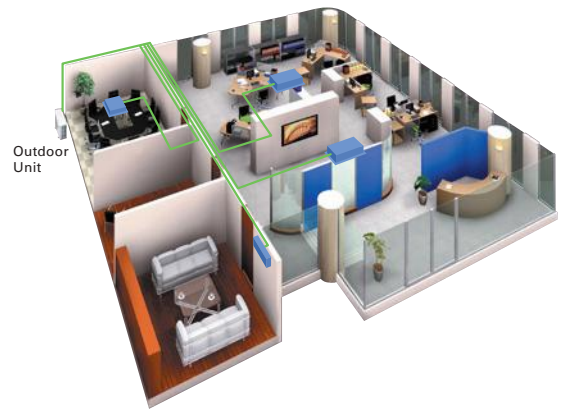

R410A

2-port

MXZ-2D33VA
MXZ-2D42VA2
MXZ-2D53VA (H)2



R410A

3-port 4-port

MXZ-3E54VA
MXZ-3E68VA
MXZ-4E72VA



R410A

4-port 5-port

MXZ-4E83VA
MXZ-5E102VA



R410A

6-port

MXZ-6D122VA2

EXAMPLE SYSTEM

MXZ-6D122VA2 system

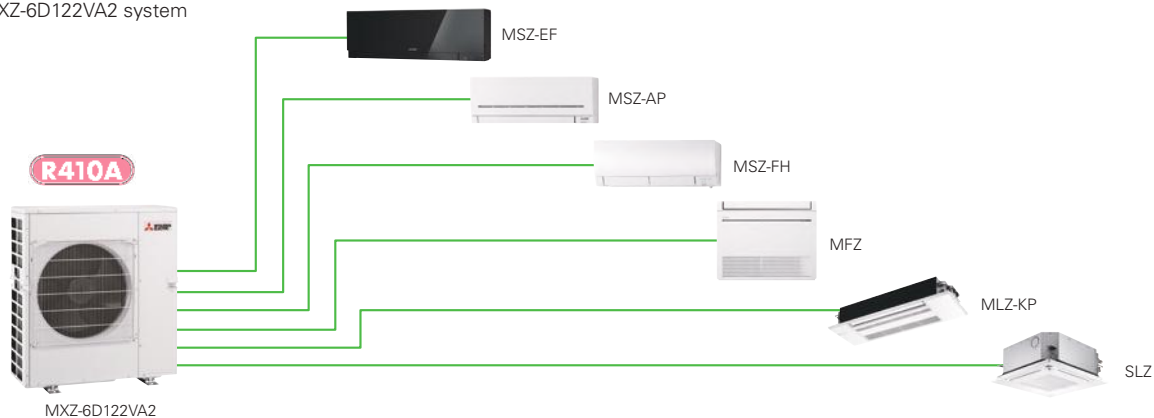

Handle Up to 6 Rooms with a Single Outdoor Unit

The MXZ Series offers a nine-system line-up to choose from, ranging between 3.3 and 12.2kW. All of them are compatible with specific M, S and P series indoor units. A single outdoor unit can handle a wide range of building layouts.

Support Functions

Wiring/Piping Correction Function* (3E54/3E68/4E72/4E83/5E102/6D122)

Simply press a single button to confirm if wiring and piping are properly connected. Wiring errors are corrected automatically when discovered. This eliminates the need to confirm complicated wiring connections when expanding the system. (For details, refer to the outdoor unit installation manual.)

* Function cannot be used when the outdoor temperature is below 0°C. The correction process requires 10–20 minutes to complete and must be conducted with the unit set to the "Cooling" mode.

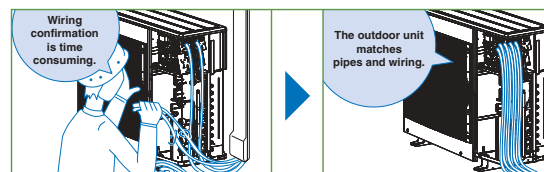

Ampere Limit Adjustment*

(4E83/5E102/6D122)

Dipswitch settings can be used to adjust the maximum electrical current for operation. This function is highly recommended for managing energy costs. (For details, refer to the outdoor unit installation manual.)

* Maximum capacity is lowered with the use of this function.

Operation Lock

To accommodate specific use applications, cooling or heating operation can be specified when setting the control board of the outdoor unit. A convenient option when a system needs to be configured for exclusive cooling or heating service. (For details, refer to the outdoor unit installation manual.)



Type (Inverter Multi - Split Heat Pump)			Up to 2 Indoor Units					Up to 3 Indoor Units		Up to 4 Indoor Units		Up to 5 Indoor Units
Indoor Unit			Please refer to*4									
Outdoor Unit			N ^o MXZ-2D33VA	N ^o MXZ-2D42VA2	N ^o MXZ-2D53VA2	N ^o MXZ-2D53VAH2	N ^o MXZ-3E54VA	N ^o MXZ-3E68VA	N ^o MXZ-4E72VA	MXZ-4E83VA	MXZ-5E102VA	
Refrigerant			R410A*1									
Power Supply			Outdoor power supply									
Source			220 - 230 - 240V / Single / 50									
Outdoor (V/Phase/Hz)			220 - 230 - 240V / Single / 50									
Cooling	Capacity	Rated	kW	3.3	4.2	5.3	5.3	5.4	6.8	7.2	8.3	10.2
		Min - Max	kW	1.1 - 3.8	1.1 - 4.4	1.1 - 5.6	1.1 - 5.6	2.9 - 6.8	2.9 - 8.4	3.7 - 8.8	3.7 - 9.2	3.9 - 11.0
	Input (Indoor+Outdoor)	Rated	kW	0.90	1.00	1.54	1.54	1.35	2.19	2.25	2.44	3.15
		Design Load	kW	3.3	4.2	5.3	5.3	5.4	6.8	7.2	8.3	10.2
	Annual Electricity Consumption*2		kWh/a	211	216	262	262	295	425	443	460	537
		SEER*4,*5		5.5	6.8	7.1	7.1	6.4	5.6	5.7	6.3	6.6
Energy Efficiency Class*4				A	A++	A++	A++	A++	A+	A+	A++	A++
Heating (Average Season)	Capacity	Rated	kW	4.0	4.5	6.4	6.4	7.0	8.6	8.6	9.3	10.5
		Min - Max	kW	1.0 - 4.1	1.0 - 4.8	1.0 - 7.0	1.0 - 7.0	2.6 - 9.0	2.6 - 10.6	3.4 - 10.7	3.4 - 11.6	4.1 - 14.0
	Input (Indoor+Outdoor)	Rated	kW	0.96	0.93	1.70	1.70	1.59	2.38	2.28	2.00	2.34
		Design Load	kW	2.7	3.2	4.5	4.5	5.0	6.8	7.0	8.7	8.9
	Declared Capacity	at reference design temperature	kW	2.1	2.7	3.7	3.6	4.0	5.4	5.6	7.1	7.3
		at bivalent temperature	kW	2.4	3.0	4.0	4.0	4.49	6.0	6.2	7.8	7.9
	Back Up Heating Capacity	at operation limit temperature	kW	1.7	2.3	3.3	3.0	3.17	4.4	4.7	6.0	6.3
			kW	0.6	0.5	0.8	0.9	1.0	1.4	1.4	1.6	1.6
	Annual Electricity Consumption*2		kWh/a	926	1065	1507	1546	1751	2466	2516	2889	2958
		SCOP*4,*6		4.1	4.2	4.2	4.1	4.0	3.9	3.9	4.2	4.2
Energy Efficiency Class*4				A+	A+	A+	A+	A	A	A+	A+	
Max. Operating Current (Indoor+Outdoor)			A	10.0	12.2	12.2	12.2	18.0	18.0	18.0	21.4	21.4
Outdoor Unit	Dimensions	H x W x D	mm	550 - 800(+69) - 285(+59.5)					710 - 840(+30) - 330(+66)		796 - 950 - 330	
	Weight		kg	32	37	37	38	58	58	59	63	64
		Air Volume	Cooling	m ³ /min	32.9	27.7	32.9	32.9	42.1	42.1	42.1	55.6
	Sound Level (SPL)	Heating	m ³ /min	33.7	33.3	33.3	33.3	43.0	43.0	43.0	55.6	68.0
		Cooling	dB(A)	49	46	50	50	50	50	50	49	52
	Sound Level (PWL)	Heating	dB(A)	50	51	53	53	53	53	53	51	56
		Cooling	dB(A)	63	60	64	64	64	64	64	61	65
Breaker Size		A	10	15	15	15	25	25	25	25	25	
Ext. Piping	Diameter	Liquid	mm	6.35 x 2	6.35 x 2	6.35 x 2	6.35 x 2	6.35 x 3	6.35 x 3	6.35 x 4	6.35 x 4	6.35 x 5
		Gas	mm	9.52 x 2	9.52 x 2	9.52 x 2	9.52 x 2	9.52 x 3	9.52 x 3	12.7x1+9.52x3	12.7x1+9.52x3	12.7x1+9.52x4
	Total Piping Length (max)	m	20	30	30	30	50	60	60	70	80	
	Each Indoor Unit Piping Length (max)	m	15	20	20	20	25	25	25	25	25	
	Max. Height	m	10	15 (10)*3	15 (10)*3	15 (10)*3	15 (10)*3	15 (10)*3	15 (10)*3	15 (10)*3	15 (10)*3	
Guaranteed Operating Range [Outdoor]	Cooling	°C	-10 ~ +46	-10 ~ +46	-10 ~ +46	-10 ~ +46	-10 ~ +46	-10 ~ +46	-10 ~ +46	-10 ~ +46	-10 ~ +46	
	Heating	°C	-15 ~ +24	-15 ~ +24	-15 ~ +24	-20 ~ +24	-15 ~ +24	-15 ~ +24	-15 ~ +24	-15 ~ +24	-15 ~ +24	

N: Please refer to the NOTE below.

Type (Inverter Multi - Split Heat Pump)			Up to 6 Indoor Units	
Indoor Unit			Please refer to*4	
Outdoor Unit			MXZ-6F120VF2	
Refrigerant			R32*1	
Power Supply			Outdoor power supply	
Source			220 - 230 - 240V / Single / 50Hz	
Outdoor (V/Phase/Hz)			220 - 230 - 240V / Single / 50Hz	
Cooling	Capacity	Rated	kW	12.0
		Min - Max	kW	3.5 - 14.0
	Input (Indoor+Outdoor)*5	Rated	kW	3.60
		Design Load	kW	12.0
	Annual Electricity Consumption*2		kWh/a	612
		SEER*4,*5		6.86
Energy Efficiency Class*4			A++	
Heating (Average Season)	Capacity	Rated	kW	14.0
		Min - Max	kW	3.5 - 16.5
	Input (Indoor+Outdoor)	Rated	kW	3.31
		Design Load	kW	8.1
	Declared Capacity	at reference design temperature	kW	6.9
		at bivalent temperature	kW	7.6
	Back Up Heating Capacity	at operation limit temperature	kW	5.7
			kW	12
	Annual Electricity Consumption*2		kWh/a	2794
		SCOP*4,*6		4.06
Energy Efficiency Class*4			A+	
Max. Operating Current (Indoor+Outdoor)			A	29.8
Outdoor Unit	Dimensions	H x W x D	mm	1048 - 950 - 330
	Weight		kg	87
		Air Volume	Cooling	m ³ /min
	Sound Level (SPL)	Heating	m ³ /min	77
		Cooling	dB(A)	55
	Sound Level (PWL)	Heating	dB(A)	57
		Cooling	dB(A)	69
	Operating Current	Cooling	A	16.4 - 15.7 - 15.1
		Heating	A	15.2 - 14.5 - 13.9
	Breaker Size		A	32
Ext. Piping	Diameter	Liquid	mm	6.35 x 6
		Gas	mm	12.7 x 1 + 9.52 x 5
	Total Piping Length (max)	m	80	
	Each Indoor Unit Piping Length (max)	m	25	
	Max. Height	m	15	
Guaranteed Operating Range [Outdoor]	Cooling	°C	-10 ~ +46	
	Heating	°C	-15 ~ +24	

NOTE

When connecting the MFZ-KJ series indoor unit(s) to this outdoor unit, charge additional refrigerant according to the instructions in the diagram below.

MXZ-2D33VA

No. of MFZ-KJ indoor units	Pipe length (L)	Maximum amount of refrigerant
1 unit	~20m	1250g
2 units	100g additional (Total 1250g)	1250g
2 units	Not available (Only one MFZ-KJ series indoor unit can be connected.)	

MXZ-2D42VA2 MXZ-2D53VA2 MXZ-2D53VAH2

No. of MFZ-KJ indoor units	Pipe length (L)	Maximum amount of refrigerant
1 unit	~20m	1600g
2 units	100g additional (Total 1400g)	1600g
2 units	200g additional (Total 1500g)	1700g

MXZ-3E54VA

No. of MFZ-KJ indoor units	Pipe length (L)	Maximum amount of refrigerant
1 unit	~40m	3000g
2 units	100g additional (Total 2800g)	3000g
2 units	200g additional (Total 2900g)	3100g
3 units	300g additional (Total 3000g)	3200g

MXZ-3E68VA MXZ-4E72VA

No. of MFZ-KJ indoor units	Pipe length (L)	Maximum amount of refrigerant
1 unit	~40m	3200g
2 units	100g additional (Total 2800g)	3200g
2 units	200g additional (Total 2900g)	3300g
3 units	300g additional (Total 3000g)	3400g

*1 Refrigerant leakage contributes to climate change. Refrigerant with lower global warming potential (GWP) would contribute less to global warming than a refrigerant with higher GWP, if leaked to the atmosphere. This appliance contains a refrigerant fluid with a GWP equal to 1975. This means that if 1kg of this refrigerant fluid would be leaked to the atmosphere, the impact on global warming would be 1975 times higher than 1kg of CO₂ over a period of 100 years. Never try to interfere with the refrigerant circuit yourself or disassemble the product yourself and always ask a professional.

*2 Energy consumption based on standard test results. Actual energy consumption will depend on how the appliance is used and where it is located.

*3 If the outdoor unit is installed higher than the indoor unit, max. height is reduced to 10m.

*4 EER/COP, EEL rank, SEER/SCOP values and energy efficiency class are measured when connected to the indoor units listed below.

- MXZ-2D33VA → MSZ-SF15VA + MSZ-EF18VE
- MXZ-2D42VA2 → MSZ-EF18VE + MSZ-EF25VE
- MXZ-2D53VA(H)2 → MSZ-EF18VE + MSZ-EF35VE
- MXZ-3E54VA → MSZ-EF18VE + MSZ-EF18VE + MSZ-EF18VE
- MXZ-3E68VA → MSZ-EF18VE + MSZ-EF25VE + MSZ-EF25VE
- MXZ-4E72VA → MSZ-EF18VE + MSZ-EF18VE + MSZ-EF18VE + MSZ-EF18VE
- MXZ-4E83VA → MSZ-EF18VE + MSZ-EF18VE + MSZ-EF22VE + MSZ-EF25VE
- MXZ-5E102VA → MSZ-EF18VE + MSZ-EF18VE + MSZ-EF22VE + MSZ-EF22VE

*5 Power input and operating current (max) figures are for outdoor unit only

*6 SEER and SCOP are based on 2009/125/EC:Energy-related Products Directive and Regulation(EU) No206/2012.

MXZ-HA SERIES

Multi-port outdoor units exclusively for MSZ-HR indoor units.



R32

2-port

MXZ-2HA40VF2
MXZ-2HA50VF2



R32

3-port

MXZ-3HA50VF2

Stylish Design with Flat Panel Front

A stylish flat panel design is employed for the front of the indoor unit. The simple look matches room aesthetics.



Easy to create various combinations

Wide range of simple combinations only possible using multi-port outdoor units.

Two bedrooms

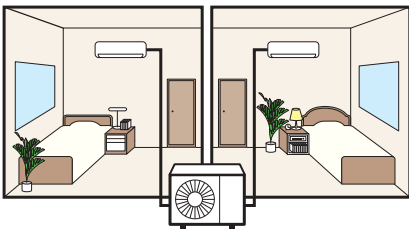

Three bedrooms

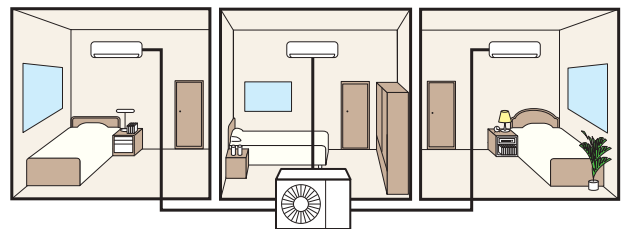

Living room and one bedroom

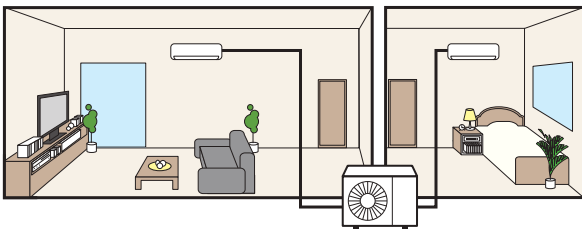

Wide living room

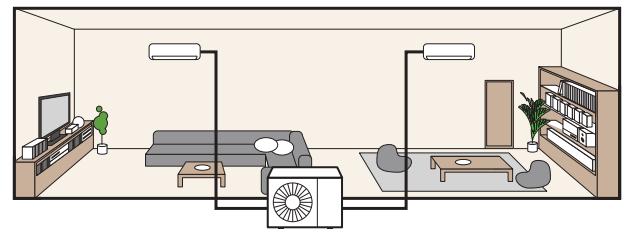

MXZ-HA SERIES

INVERTER MULTI



Type (Inverter Multi - Split Heat Pump)				Up to 2 Indoor Units		Up to 3 Indoor Units		
Indoor Unit				Please refer to*3				
Outdoor Unit				MXZ-2HA40VF2	MXZ-2HA50VF2	MXZ-3HA50VF2		
Refrigerant				R32				
Power Source				Outdoor power supply				
Supply Outdoor (V/Phase/Hz)				220 - 230 - 240V / Single / 50Hz				
Cooling	Capacity	Rated	kW	4.0	5.0	5.0		
		Min-Max	kW	1.1 - 4.3	1.1 - 5.4	2.9 - 6.5		
	Input	Rated	kW	1.05	1.52	1.26		
	Design Load		kW	4.0	5.0	5.0		
	Annual Electricity Consumption*2		kWh/a	172	225	241		
	SEER*1			8.12	7.78	7.26		
				Energy Efficiency Class*3				
Heating	Capacity	Rated	kW	4.3	6.0	6.0		
		Min-Max	kW	1.0 - 4.7	1.0 - 6.4	2.6 - 7.5		
	Input	Rated	kW	0.91	1.54	1.30		
	Design Load		kW	3.2	3.2	4.0		
	Declared Capacity	at reference design temperature	kW	2.4	2.4	3.0		
		at bivalent temperature	kW	2.9	2.9	3.6		
		at operation limit temperature	kW	2.1	2.1	2.6		
	Back Up Heating Capacity		kW	0.8	0.8	1.0		
	Annual Electricity Consumption*2		kWh/a	1043	1043	1394		
	SCOP*3			4.30	4.30	4.02		
					Energy Efficiency Class*3			
					A+			
Max. Operating Current (Indoor+Outdoor)				A	12.2	18.0		
Outdoor Unit	Dimensions	H x W x D	mm	550 - 800 (+69) - 285 (+59.5)			710 - 840 - 330 (+66)	
	Weight		kg	37	37	57		
	Air Volume	Cooling	m ³ /min	28.4	32.7	31.0		
		Heating	m ³ /min	33.5	34.7	29.1		
	Sound Level (SPL)	Cooling	dB(A)	44	47	46		
		Heating	dB(A)	50	51	50		
	Sound Level (PWL)	Cooling	dB(A)	59	64	61		
Breaker Size		A	15	15	25			
Ext. Piping	Port Diameter	Liquid	mm	6.35 x 2	6.35 x 2	6.35 x 3		
		Gas	mm	9.52 x 2	9.52 x 2	9.52 x 3		
	Total Piping Length (max)		m	30	30	50		
	Each Indoor Unit Piping Length (max)		m	20	20	25		
	Max. Height		m	15(10)*2	15(10)*2	15(10)*2		
Chargeless Length		m	30	30	40			
Guaranteed Operating Range [Outdoor]	Cooling	°C		-10 ~ +46				
	Heating	°C		-15 ~ +24				
Chargeless Length			R32/675*4	R32/675*4	R32/675*4			
Pre-Charged Quantity	Weight	Kg	0.9	0.9	1.4			
	CO ₂ equivalent	t	0.61	0.61	0.95			
Max Added Quantity	Weight	Kg	0.9	0.9	1.6			
	CO ₂ equivalent	t	0.61	0.61	1.08			

*1 Energy consumption based on standard test results.

Actual energy consumption will depend on how the appliance is used and where it is located.

*2 If the outdoor unit is installed higher than the indoor unit, max. height is reduced to 10 m.

*3 SEER/SCOP values and energy efficiency class are measured when connected to the indoor units listed below.

MXZ-2HA40VF2 → MSZ-HR25VF + MSZ-HR25VF

MXZ-2HA50VF2 → MSZ-HR25VF + MSZ-HR25VF

MXZ-3HA50VF2 → MSZ-HR25VF + MSZ-HR25VF + MSZ-HR25VF

*4 This GWP value is based on Regulation(EU) No 517/2014 from IPCC 4th edition,

PUMY-SP SERIES

Air conditioning system supports replacement work by simplifying the installation process. Ideal for supporting renewal needs at small offices and stores, home offices, etc.



R410A

PUMY-SP112/125/140VKM2
PUMY-SP112/125/140YKM2

EXAMPLE SYSTEM

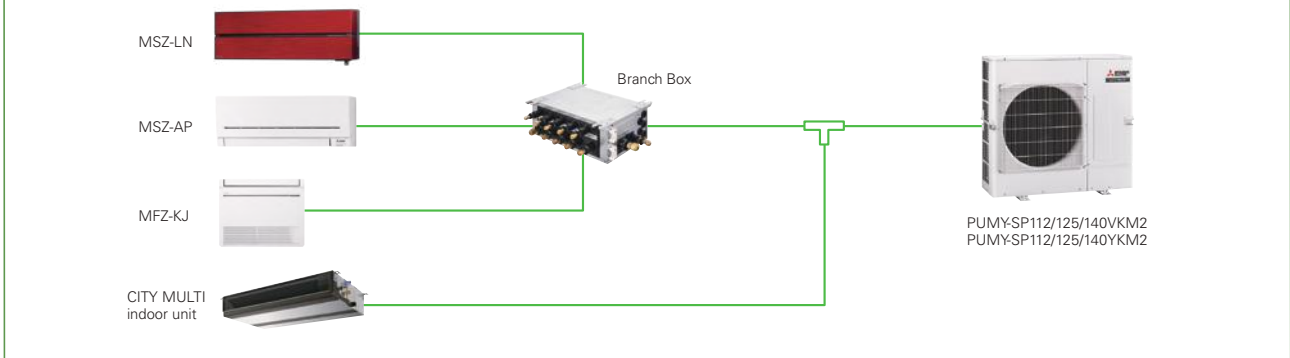

Light weight and compact size

Compact design fits into narrow outdoor unit space of condominiums and offices. Light weight design facilitates easy installation and transportation.

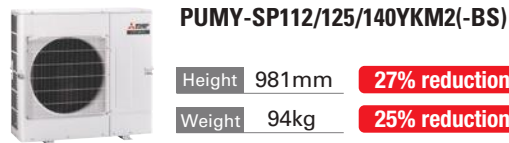
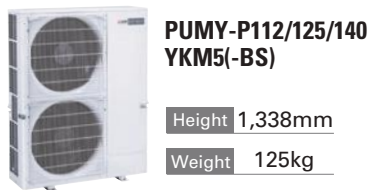

Unobstructive, compact, and easy to hide from view

Conventional 2-fan type outdoor units may spoil the view. Due to its compact size, the new outdoor fan unit can be installed in locations that would have been inappropriate.

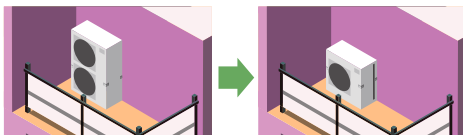

Easy installation and transportation

The reduced weight and height allow for better transportation performance. Carrying and installing become easier.

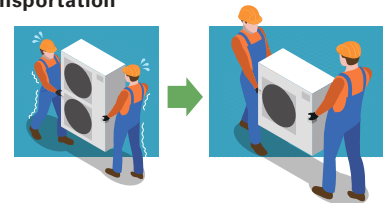

Industry's top energy efficiency

Even with its compact size and light weight, it has a high EER and COP. Costs are reduced with the industry's best energy saving abilities.

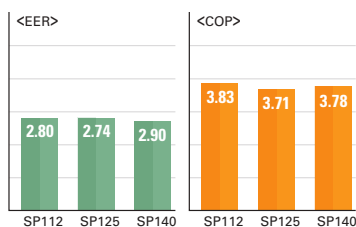

An external static pressure of 30Pa

The installation location is flexible, thanks to its 30Pa static pressure. You can install it in locations that you could not before.

An external static pressure of 30Pa allows outdoor unit to be installed on balconies in high-rise building or spaces near louvers.

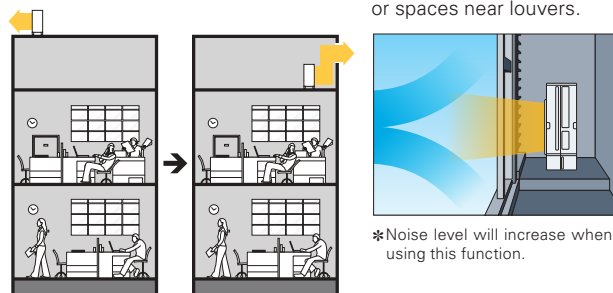

*Noise level will increase when using this function.

Super silent mode*

Noise level can be reduced up to 10dB(A). This allows you to operate the unit even in the night in a residential zone.

*Capacity reduction differs by mode setting.

*PAC-SC36NA-E is required to activate Super Silent mode.

Rear piping is available

Freedom with layout due to its piping pullout locations in four directions

The in-door unit allows piping from any four directions; front, back, bottom, or right. This enables easier horizontal connection for collective layout.

The out-door unit with an expanded piping layout flexibility greatly improves piping workability.

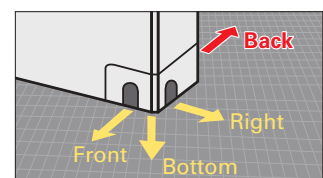

Model	PUMY-SP112VKM2 (-BS)	PUMY-SP125VKM2 (-BS)	PUMY-SP140VKM2 (-BS)	PUMY-SP112YKM2 (-BS)	PUMY-SP125YKM2 (-BS)	PUMY-SP140YKM2 (-BS)	
Power Source	1-phase 220-230-240V 50Hz, 220V 60Hz			3-phase 380-400-415V 50Hz, 380V 60Hz			
Cooling Capacity (Nominal)	Power Input	12.5	14.0	15.5	12.5	14.0	
	Current Input	4.46	5.11	5.34	4.46	5.11	
	EER	20.69 - 19.79 - 18.97, 20.69	23.71 - 22.68 - 21.73, 23.71	24.77 - 23.70 - 22.71, 24.77	7.14 - 6.78 - 6.54, 7.14	8.18 - 7.77 - 7.49, 8.18	8.55 - 8.12 - 7.83, 8.55
	W.B.	2.80	2.74	2.90	2.80	2.74	
Temp. Range of Cooling	Indoor Temp.	15.0-24.0°C (59-75°F)	15.0-24.0°C (59-75°F)	15.0-24.0°C (59-75°F)	15.0-24.0°C (59-75°F)	15.0-24.0°C (59-75°F)	
	Outdoor Temp.*2	D.B. -5.0-52.0°C (23-126°F)	-5.0-52.0°C (23-126°F)	-5.0-52.0°C (23-126°F)	-5.0-52.0°C (23-126°F)	-5.0-52.0°C (23-126°F)	
Heating Capacity (Nominal)	Power Input	14.0	16.0	16.5	14.0	16.0	
	Current Input	3.66	4.31	4.36	3.66	4.31	
	COP	16.98 - 16.24 - 15.57, 16.98	20.00 - 19.13 - 18.33, 20.00	20.23 - 19.35 - 18.54, 20.23	5.86 - 5.57 - 5.36, 5.86	6.90 - 6.55 - 6.32, 6.90	6.98 - 6.63 - 6.39, 6.98
	W.B.	3.83	3.71	3.78	3.83	3.71	
Temp. Range of Heating	Indoor Temp.	15.0-27.0°C (59-81°F)	15.0-27.0°C (59-81°F)	15.0-27.0°C (59-81°F)	15.0-27.0°C (59-81°F)	15.0-27.0°C (59-81°F)	
	Outdoor Temp.	W.B. -20.0-15.0°C (-4-59°F)	-20.0-15.0°C (-4-59°F)	-20.0-15.0°C (-4-59°F)	-20.0-15.0°C (-4-59°F)	-20.0-15.0°C (-4-59°F)	
Indoor Unit Connectable	Total Capacity	50-130 % of outdoor unit capacity					
	Model / Quantity	City Multi*4	10-140/12	10-140/12	10-140/12	10-140/12	10-140/12
	Mixed System	Branch Box*5	15-100/8	15-100/8	15-100/8	15-100/8	15-100/8
		City Multi	10-140/5	10-140/5	10-140/5	10-140/5	10-140/5
		Branch Box*6	15-100/5	15-100/5	15-100/5	15-100/5	15-100/5
		City Multi	10-140/3	10-140/3	10-140/3	10-140/3	10-140/3
Branch Box*5		15-100/8	15-100/8	15-100/8	15-100/8	15-100/8	
Sound Pressure Level (Measured In Anechoic Room)	dB <A>	52/54	53/56	54/56	52/54	53/56	
Sound Power Level (Measured In Anechoic Room)	dB <A>	72/74	73/76	74/76	72/74	73/76	
Refrigerant Piping Diameter	Liquid Pipe	mm (in.) 9.52 (3/8)					
	Gas Pipe	mm (in.) 15.88 (5/8)					
Fan	Type x Quantity	Propeller Fan x 1					
	Air Flow Rate	m³/min	77	83	83	77	83
		L/s	1,283	1,383	1,383	1,283	1,383
		cfm	2,719	2,931	2,931	2,719	2,931
	Motor Output	kW 0.20 x 1					
	External Static Press.	0Pa / 30Pa*6					
Compressor	Type x Quantity	Twin rotary hermetic compressor x 1					
	Starting Method	Inverter					
	Motor Output	kW 3.9					
External dimension H x W x D	mm	981 x 1,050 x 330 (+40)					
	in.	38-5/8 x 41-3/8 x 13 (+1-37/64)					
Net Weight	kg (lbs)	93 (205)*7			94 (207)*8		

*1, *3 Nominal conditions

	Indoor	Outdoor	Piping Length	Level Difference	External Static Press. (Outdoor Unit)
Cooling	27°C DB / 19°C WB	35°C	7.5m (24 - 9' 16ft.)	0m (0ft)	0 Pa
Heating	20°C DB	7°C DB / 6°C WB	7.5m (24 - 9' 16ft.)	0m (0ft)	0 Pa

*2 10 to 52°C; incase of connecting PKFY-P15/P20/P25VBM, PKFY-P10/15/20/25/32VLM, PFFY-P20/P25/P32VKM, PFFY-P20/25/32VCM, PFFY-P20/P25/P32VLE(R)M indoor unit and M series indoor unit with connection kit and M series, S series, and P series type indoor unit with branch box.

*4 It is possible to connect 1 Fresh Air type indoor unit to 1 outdoor unit. (1:1 system)

*5 At least 2 indoor units must be connected when using branch box.

*6 0 Pa as initial setting

*7 94 (207), for PUMY-SP112/125/140YKM2-BS

*8 95 (209), for PUMY-SP112/125/140YKM2-BS

Type	Branch Box	
Model Name	PAC-MK54BC	PAC-MK34BC
Connectable Number of Indoor Units	Maximum 5	Maximum 3
Power Supply (from outdoor unit)	~ / N, 220 / 230 / 240 V, 50 Hz, ~ / N, 220 / 230 V, 60 Hz	
Input	kW 0.003	
Running Current	A 0.05 (Max. 6)	
Dimensions	H x W x D mm 170 x 450 x 280	
Weight	kg 7.4	
Piping Connection (Flare)	Branch [Indoor Side]	Liquid mm ø6.35 x 5
		Gas mm ø9.52 x 4, ø12.7 x 1
	Main [Outdoor Side]	Liquid mm ø9.52
		Gas mm ø15.88

* The piping connection size differs according to the type and capacity of outdoor/indoor units. Match the piping connection size of branch box with outdoor/indoor unit. If the piping connection size of branch box does not match the piping connection size of outdoor/indoor unit, use optional different-diameter (deformed) joints to the branch box side. (Connect deformed joint directly to the branch box side.)

<Branch box compatible table>

Outdoor unit		Branch box	PAC-MK31/51BC(B)	PAC-MK32/52BC(B)	PAC-MK33/53BC(B)	PAC-MK33/54BC
Outdoor unit 1fan	PUMY-SP112/125/140V/YKM2(-BS)		N/A	N/A	✓*	✓*
Outdoor unit 2fan	PUMY-P112/125/140VKM6(-BS)		N/A	N/A	✓	✓
	PUMY-P112/125/140YKM5(-BS)		N/A	N/A	✓	✓
	PUMY-P200YKM3(-BS)		N/A	N/A	✓*	✓*
	PUMY-P250/300YBM2(-BS)		N/A	N/A	✓*	✓*

*ecodan is NG

[SP112-140V/YKM2(-BS)]

Refrigerant Piping Lengths	Maximum meters	Vertical differentials between units	Maximum meters
Total length	120	Indoor/outdoor (outdoor higher)	50
Maximum allowable length	To City Multi indoor unit: 70	Indoor/outdoor (outdoor lower)	30
	Through Branch box: 80	Indoor/indoor	15*

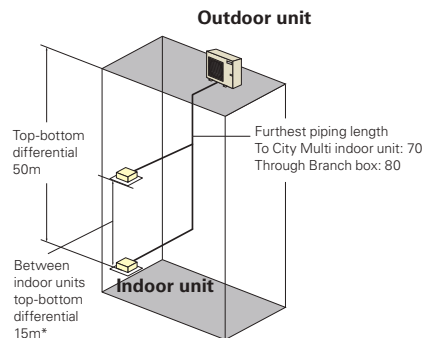

*In case of branch box connection: 12m

PUMY-P SERIES

Air conditioning system supports replacement work by simplifying the installation process. Ideal for supporting renewal needs at small offices and stores, home offices, etc.



R410A

PUMY-P112/125/140VKM6
PUMY-P112/125/140YKM5
PUMY-P200YKM3
PUMY-P250/300YBM2

EXAMPLE SYSTEM

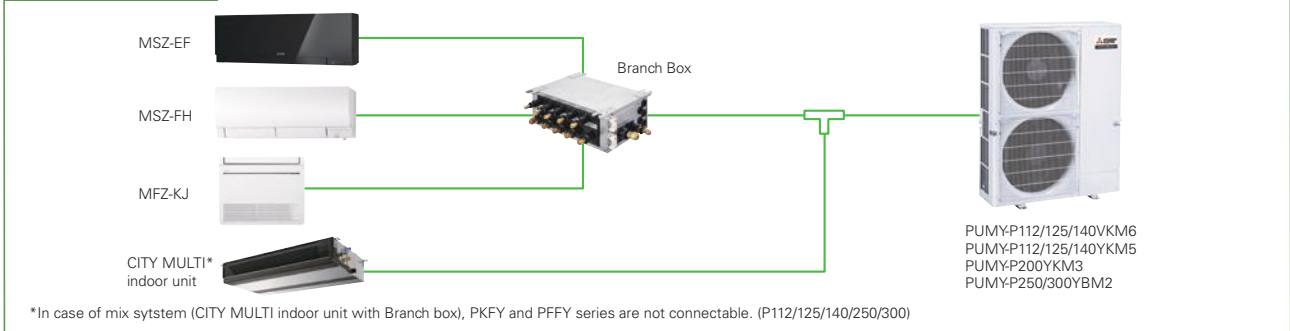

The two-pipe zoned system designed for Heat Pump Operation

PUMY series make use of a two-pipe refrigerant system, which allows for system changeover from cooling to heating, ensuring that a constant indoor climate is maintained in all zones. The compact outdoor unit utilizes R410A refrigerant and an INVERTER-driven compressor to use energy effectively.

With a wide range of indoor unit line-up in connection with a flexible piping system, PUMY series can be configured for all applications. Up to 12 (P250/300: Up to 30) indoor units can be connected with up to 130% connected capacity to maximize engineer's design options. This feature allows easy air conditioning in each area with convenient individual controllers.

Small Offices

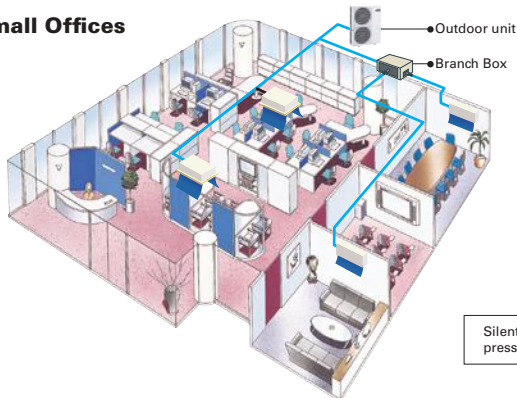

Residence

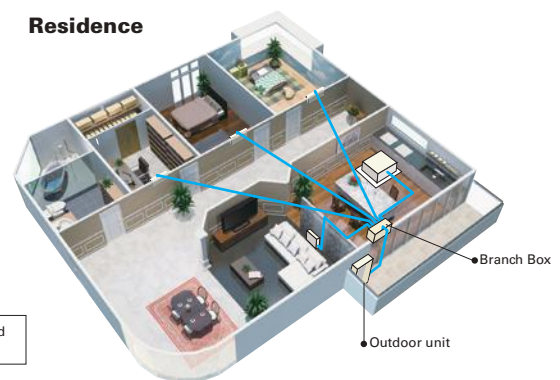

Silent mode can reduce sound pressure level by 3dB(A)

		Maximum Meters			
		Only City Multi*1 Indoor Unit	Only Branch Box Connection	Mixed System (City Multi*1 Indoor Unit + Branch Box)	
P112/125/140	Refrigerant Piping Length	Total Length	300	150	240 (2 Branch boxes) / 300 (1 Branch box)
		Maximum Allowable Length	150 (175 equivalent)	80	85 (95 equivalent)
		Farthest Indoor From First Branch	30	30	-
		Piping Length Between Outdoor Unit and Branch Boxes	-	55	55
	Vertical Differentials Between Units	Indoor/Outdoor (Outdoor higher)	50	50	50
		Indoor/Outdoor (Outdoor Lower)	40*2	40	40
		Indoor/Indoor	15	12	12
P200	Refrigerant Piping Length	Total Length	150	150	150
		Maximum Allowable Length	80 (90 equivalent)	80	80 (90 equivalent)
		Farthest Indoor From First Branch	30	30	-
		Piping Length Between Outdoor Unit and Branch Boxes	-	55	55
	Vertical Differentials Between Units	Indoor/Outdoor (Outdoor higher)	50	50	50
		Indoor/Outdoor (Outdoor Lower)	40	40	40
		Indoor/Indoor	15	12	12
P250/300	Refrigerant Piping Length	Total Length	310	240	310
		Maximum Allowable Length	150 (175 equivalent)	80	85 (95 equivalent)
		Farthest Indoor From First Branch	30	30	-
		Piping Length Between Outdoor Unit and Branch Boxes	-	95	95
	Vertical Differentials Between Units	Indoor/Outdoor (Outdoor higher)	50	50	50
		Indoor/Outdoor (Outdoor Lower)	40	40	40
		Indoor/Indoor	15	12	12

*1 Include system with connection kit *2 In case of including PKFY or PFFY, height between units is 30m.

30Pa external static pressure* Option (requires PAC-SJ71FM-E)

An external static pressure of 30Pa enables the outdoor unit to be installed on balconies in high-rise building or spaces near louvers.

* PUMY-P112/125/140VKM6(-BS), PUMY-P112/125/140YKM5(-BS) only.
* Noise level will increase when using this function.

30Pa external static pressure fan motor (option)
(PAC-SJ71FM-E)

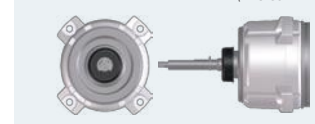



Model		PUMY-P112VKM6 (-BS)	PUMY-P125VKM6 (-BS)	PUMY-P140VKM6 (-BS)	PUMY-P112YKM6 (-BS)	PUMY-P125YKM6 (-BS)	PUMY-P140YKM6 (-BS)	PUMY-P200YKM3 (-BS)	PUMY-P250YBM2 (-BS)	PUMY-P300YBM2 (-BS)	
Power Source		1-phase 220-230-240V 50Hz, 220-230V 60Hz			3-phase 380-400-415V 50Hz, 380V 60Hz			3-phase 380-400-415V 50Hz			
Cooling Capacity (Nominal)	Power Input	kW	12.5	14.0	15.5	12.5	14.0	15.5	22.4	28.0	33.5
	Current Input	A	4.34	5.00	5.17	4.34	5.00	5.17	7.18	8.21	11.96
	EER	kW/kW	2.88	2.80	3.00	2.88	2.80	3.00	3.12	3.41	3.41
Temp. Range of Cooling	Indoor Temp.	W.B.	15.0-24.0°C (59-75°F)	15.0-24.0°C (59-75°F)	15.0-24.0°C (59-75°F)	15.0-24.0°C (59-75°F)	15.0-24.0°C (59-75°F)	15.0-24.0°C (59-75°F)	15.0-24.0°C (59-75°F)	15.0-24.0°C (59-75°F)	15.0-24.0°C (59-75°F)
	Outdoor Temp.	D.B.	-5.0-52.0°C (23-126°F)	-5.0-52.0°C (23-126°F)	-5.0-52.0°C (23-126°F)	-5.0-52.0°C (23-126°F)	-5.0-52.0°C (23-126°F)	-5.0-52.0°C (23-126°F)	-5.0-52.0°C (23-126°F)	-5.0-52.0°C (23-126°F)	-5.0-52.0°C (23-126°F)
Heating Capacity (Nominal)	Power Input	kW	14.0	16.0	18.0	14.0	16.0	18.0	25.0	31.5	37.5
	Current Input	A	3.49	4.06	4.63	3.49	4.06	4.63	5.85	7.91	9.69
	COP	kW/kW	4.01	3.94	3.89	4.01	3.94	3.89	4.27	3.98	3.87
Temp. Range Of Heating	Indoor Temp.	D.B.	15.0-27.0°C (59-81°F)	15.0-27.0°C (59-81°F)	15.0-27.0°C (59-81°F)	15.0-27.0°C (59-81°F)	15.0-27.0°C (59-81°F)	15.0-27.0°C (59-81°F)	15.0-27.0°C (59-81°F)	15.0-27.0°C (59-81°F)	15.0-27.0°C (59-81°F)
	Outdoor Temp.	W.B.	-20.0-15.0°C (4-59°F)	-20.0-15.0°C (4-59°F)	-20.0-15.0°C (4-59°F)	-20.0-15.0°C (4-59°F)	-20.0-15.0°C (4-59°F)	-20.0-15.0°C (4-59°F)	-20.0-15.0°C (4-59°F)	-20.0-15.0°C (4-59°F)	-20.0-15.0°C (4-59°F)
Indoor Unit Connectable	Total Capacity		50-130% of outdoor unit capacity			50-130% of outdoor unit capacity			50-130% of outdoor unit capacity		
	Model / Quantity		10 - 140 / 9			10 - 140 / 12			10 - 140 / 12		
	Mixed System	Branch Box 1 unit	City Multi ^{**}	10 - 140 / 9	10 - 140 / 10	10 - 140 / 12	10 - 140 / 9	10 - 140 / 10	10 - 140 / 12	10 - 250 / 30	10 - 250 / 30
		Branch Box 2 units	Branch Box ^{**}	15 - 100 / 8	15 - 100 / 8	15 - 100 / 8	15 - 100 / 8	15 - 100 / 8	15 - 100 / 8	15 - 50 / 12	15 - 50 / 12
		Branch Box 3 units	Branch Box ^{**}	15 - 100 / 5	15 - 100 / 5	15 - 100 / 5	15 - 100 / 5	15 - 100 / 5	15 - 100 / 5	10 - 250 / 25	10 - 250 / 25
	City Multi	Branch Box 1 unit	City Multi	10 - 140 / 5	10 - 140 / 5	10 - 140 / 5	10 - 140 / 5	10 - 140 / 5	10 - 140 / 5	10 - 200 / 5	10 - 250 / 25
		Branch Box 2 units	Branch Box ^{**}	15 - 100 / 5	15 - 100 / 5	15 - 100 / 5	15 - 100 / 5	15 - 100 / 5	15 - 100 / 5	15 - 100 / 5	15 - 100 / 5
		Branch Box 3 units	Branch Box ^{**}	15 - 100 / 7 or 8 ^{**3}	15 - 100 / 3	10 - 140 / 3	10 - 140 / 3 or 2 ^{**3}	10 - 140 / 3	10 - 200 / 3	10 - 250 / 23	10 - 250 / 23
	City Multi	Branch Box 1 unit	City Multi	10 - 140 / 3 or 2 ^{**3}	10 - 140 / 3	10 - 140 / 3	10 - 140 / 3	10 - 140 / 3	10 - 200 / 3	10 - 250 / 23	10 - 250 / 23
	City Multi	Branch Box 2 units	Branch Box ^{**}	15 - 100 / 7 or 8 ^{**3}	15 - 100 / 8	15 - 100 / 8	15 - 100 / 8	15 - 100 / 8	15 - 50 / 10	15 - 50 / 10	
City Multi	Branch Box 3 units	Branch Box ^{**}	-	-	-	-	-	10 - 250 / 22	10 - 250 / 22		
Sound Pressure Level (Measured In Anechoic Room)		dB <A>	49/51	50/52	51/53	49/51	50/52	51/53	57/61	55/61	57/62
Sound Power Level (Measured In Anechoic Room)		dB <A>	69/71	70/72	71/73	69/71	70/72	71/73	76/80	74/79	75/79
Refrigerant Piping Diameter	Liquid Pipe	mm (in.)	9.52 (3/8)	9.52 (3/8)	9.52 (3/8)	9.52 (3/8)	9.52 (3/8)	9.52 (3/8)	9.52 (3/8) ^{**7}	9.52 (3/8) ^{**8}	12.7 (1/2)
	Gas Pipe	mm (in.)	15.88 (5/8)	15.88 (5/8)	15.88 (5/8)	15.88 (5/8)	15.88 (5/8)	15.88 (5/8)	19.05 (4/3)	19.05 (4/3)	22.4 (7/8)
Fan	Type x Quantity		Propeller Fan x 2			Propeller Fan x 2			Propeller Fan x 2		
	Air Flow Rate		m ³ /min			m ³ /min			m ³ /min		
			L/s			L/s			L/s		
Compressor	Motor Output		kW			kW			kW		
			0.074 x 2			0.074 x 2			0.074 x 2		
			0.074 x 2			0.074 x 2			0.074 x 2		
Type x Quantity		Scroll hermetic compressor x 1									
Starting Method		Inverter									
Motor Output		kW			kW			kW			
		2.9			3.5			3.9			
External Dimension H x W x D		mm			mm			mm			
		1,338 x 1,050 x 330 (+30)			1,338 x 1,050 x 330 (+30)			1,662 x 1,050 x 460 (+45)			
		in.			in.			in.			
		52-11/16 x 41-11/32 x 13 (+1-9/16)			52-11/16 x 41-11/32 x 13 (+1-9/16)			65-7/16 x 41-11/32 x 187/64 (+1-49/64)			
Net Weight		kg (lbs)			kg (lbs)			kg (lbs)			
		123 (271)			125 (276)			141 (311)			

*1, *4 Nominal conditions

	Indoor	Outdoor	Piping Length	Level Difference
Cooling	27°C DB / 19°C WB	35°C	7.5m	0m
Heating	20°C DB	7°C DB / 6°C WB	7.5m	0m

*2 10 to 52°C D.B.: When connecting PKFY-P10/15/20/25/32VLM, PKFY-P15/20/25VBM, PFFY-P20/25/32VKM and PFFY-P20/25/32VCM, PFFY-P20/25/32VLE(R)M, PFFY-P-VMA3, M, S and P series indoor unit.

*3 When connecting 7 indoor units via branch box, connectable City Multi indoor units are 3; connecting 8 indoor units via branch box, connectable indoor units are 2.

*5 It is possible to connect 1 Fresh Air type indoor unit to 1 outdoor unit. (1:1 system)

*6 At least 2 indoor units must be connected when using branch box.

*7 Liquid pipe diameter: 12.7mm when piping length is more than 60m.

*8 Liquid pipe diameter: 12.7mm, when further piping length is longer than 90m, and when PEFYP200 or P250 is connected.

Type	Branch Box				
Model Name	PAC-MK54BC	PAC-MK34BC			
Connectable Number of Indoor Units	Maximum 5	Maximum 3			
Power Supply (from outdoor unit)	~ / N, 220 / 230 / 240 V, 50 Hz, ~ / N, 220 / 230 V, 60 Hz				
Input	kW				
	0.003				
Running Current	A				
	0.05 (Max. 6)				
Dimensions	H x W x D				
	mm				
	170 x 450 x 280				
Weight	kg				
	7.4				
Piping Connection (Flare)	Branch [Indoor Side]	Liquid	mm	ø6.35 x 5	ø6.35 x 3
		Gas	mm	ø9.52 x 4, ø12.7 x 1	ø9.52 x 3
	Main [Outdoor Side]	Liquid	mm	ø9.52	
		Gas	mm	ø15.88	

* The piping connection size differs according to the type and capacity of outdoor/indoor units. Match the piping connection size of branch box with outdoor/indoor unit. If the piping connection size of branch box does not match the piping connection size of outdoor/indoor unit, use optional different-diameter (deformed) joints to the branch box side. (Connect deformed joint directly to the branch box side.)

Indoor Unit Compatibility Table

■ MXZ Series R32

Possible combinations of outdoor units and indoor units are shown below.

Indoor Unit		Outdoor Unit	Inverter Models Heat pump type															
			MXZ ⁻³ 2F33VF4	MXZ ⁻³ 2F42VF4	MXZ ⁻³ 2F53VF(H)4	MXZ ⁻³ 2F53VFH2	MXZ ⁻³ 3F54VF4	MXZ ⁻³ 3F68VF4	MXZ ⁻³ 4F72VF4	MXZ ⁻³ 4F80VF4	MXZ ⁻³ 4F83VF2	MXZ ⁻³ 4F83VF22	MXZ ⁻³ 5F102VF2	MXZ ⁻³ 6F120VF2	MXZ ⁻³ 2HA40VF2	MXZ ⁻³ 2HA50VF2	MXZ ⁻³ 3HA50VF2	
M series	Wall-Mounted	MSZ-RW25VG	●	●	●	●	●	●	●	●	●	●	●	●				
		MSZ-RW35VG	●	●	●	●	●	●	●	●	●	●	●	●				
		MSZ-RW50VG	●	●	●	●	●	●	●	●	●	●	●	●				
		MSZ-LN18VG2(W)(R)(B)	●	●	●	●	●	●	●	●	●	●	●	●				
		MSZ-LN25VG2(W)(R)(B)	●	●	●	●	●	●	●	●	●	●	●	●				
		MSZ-LN35VG2(W)(R)(B)		●	●	●	●	●	●	●	●	●	●	●				
		MSZ-LN50VG2(W)(R)(B)			●	●	●	●	●	●	●	●	●	●				
		MSZ-FT25VG				●						●						
		MSZ-FT35VG				●						●						
		MSZ-FT50VG										●						
		MSZ-AP15VG(K)		●	●	●	●	●	●	●	●	●	●	●	●			
		MSZ-AP20VG(K)		●	●	●	●	●	●	●	●	●	●	●	●			
		MSZ-AY25VG(K)		●	●	●	●	●	●	●	●	●	●	●	●			
		MSZ-AY35VG(K)			●	●	●	●	●	●	●	●	●	●	●			
		MSZ-AY42VG(K)				●	●	●	●	●	●	●	●	●	●			
		MSZ-AY50VG(K)				●	●	●	●	●	●	●	●	●	●			
		MSZ-AP60VG(K)								●	●	●	●	●	●			
		MSZ-AP71VG(K)									●	●	●	●	●			
		MSZ-EF18VG(K)(W)(B)(S)		●	●	●	●	●	●	●	●	●	●	●	●			
		MSZ-EF22VG(K)(W)(B)(S)		●	●	●	●	●	●	●	●	●	●	●	●			
	MSZ-EF25VG(K)(W)(B)(S)		●	●	●	●	●	●	●	●	●	●	●	●				
	MSZ-EF35VG(K)(W)(B)(S)			●	●	●	●	●	●	●	●	●	●	●				
	MSZ-EF42VG(K)(W)(B)(S)				●	●	●	●	●	●	●	●	●	●				
	MSZ-EF50VG(K)(W)(B)(S)				●	●	●	●	●	●	●	●	●	●				
	MSZ-BT20VG(K)		●	●	●	●	●	●	●	●	●	●	●	●				
	MSZ-BT25VG(K)		●	●	●	●	●	●	●	●	●	●	●	●				
	MSZ-BT35VG(K)			●	●	●	●	●	●	●	●	●	●	●				
	MSZ-BT50VG(K)				●	●	●	●	●	●	●	●	●	●				
	MSZ-HR25VF(K)														●	●	●	
	MSZ-HR35VF(K)														●	●	●	
MSZ-HR42VF(K)															●	●		
MSZ-HR50VF(K)																●		
MSZ-HR60VF(K)																●		
MSZ-HR71VF(K)																		
S series	2x2 Cassette	MFZ-KT25VG	●	●	●	●	●	●	●	●	●	●	●					
		MFZ-KT35VG		●	●	●	●	●	●	●	●	●	●					
		MFZ-KT50VG			●	●	●	●	●	●	●	●	●					
		MLZ-KP25VF	●	●	●	●	●	●	●	●	●	●	●	●				
	Ceiling-Concealed	MLZ-KP35VF		●	●	●	●	●	●	●	●	●	●	●				
		MLZ-KP50VF			●	●	●	●	●	●	●	●	●	●				
		MLZ-KY20VG	●	●	●	●	●	●	●	●	●	●	●	●				
		SLZ-M15FA2	●	●	●	●	●	●	●	●	●	●	●	●				
		SLZ-M25FA2	●	●	●	●	●	●	●	●	●	●	●	●				
		SLZ-M35FA2		●	●	●	●	●	●	●	●	●	●	●				
		SLZ-M50FA2			●	●	●	●	●	●	●	●	●	●				
		SEZ-M25DA2 *2	●	●	●	●	●	●	●	●	●	●	●	●				
		SEZ-M25DAL2 *2	●	●	●	●	●	●	●	●	●	●	●	●				
		SEZ-M35DA2		●	●	●	●	●	●	●	●	●	●	●				
		SEZ-M35DAL2			●	●	●	●	●	●	●	●	●	●				
SEZ-M50DA2				●	●	●	●	●	●	●	●	●						
SEZ-M50DAL2					●	●	●	●	●	●	●	●						
SEZ-M60DA2					●	●	●	●	●	●	●	●						
SEZ-M60DAL2						●	●	●	●	●	●	●						
SEZ-M71DA2						●	●	●	●	●	●	●						
SEZ-M71DAL2							●	●	●	●	●	●						
Concealed Floor-Standing	SFZ-M25VA	●	●	●	●	●	●	●	●	●	●	●	●					
	SFZ-M35VA		●	●	●	●	●	●	●	●	●	●	●					
	SFZ-M50VA			●	●	●	●	●	●	●	●	●	●					
	SFZ-M60VA				●	●	●	●	●	●	●	●	●					
SFZ-M71VA						●	●	●	●	●	●	●						
P series	Ceiling-Suspended	PCA-M50KA2					●	●	●	●								
		PCA-M60KA2						●	●	●								
		PCA-M71KA2							●	●	●							
	Ceiling-Concealed	PEAD-M35JA2					●*1	●*1	●*1	●*1	●*1	●*1*4	●*1	●*1				
		PEAD-M35JAL2					●*1	●*1	●*1	●*1	●*1	●*1*4	●*1	●*1				
		PEAD-M50JA2					●	●	●	●	●	●*1*4	●*1	●*1				
		PEAD-M50JAL2					●*1	●*1	●*1	●*1	●*1	●*1*4	●*1	●*1				
		PEAD-M60JA2									●	●*1*4	●*1	●*1				
		PEAD-M60JAL2										●*1	●*1*4	●*1	●*1			
		PEAD-M71JA2										●*1	●*1*4	●*1	●*1			
PEAD-M71JAL2										●*1	●*1*4	●*1	●*1					

*1 Maximum total current of indoor units: 3A or less.

*2 SEZ-M25 cannot be connected with MXZ-2F/3F/4F when total capacity of connected indoor units is equivalent to outdoor capacity (capacity ratio is 1).

*3 MXZ outdoor units are not designed to operate with a single indoor unit with one-to-one piping work. Please install at least two indoor units.

*4 P series cannot be connected with MXZ-4F83VFH22 when ampere limit adjustment function is operated.

MXZ Series R410A

Possible combinations of outdoor units and indoor units are shown below.

Indoor Unit	Outdoor Unit	Inverter Models Heat pump type													
		MXZ- ⁻³ 2D33VA	MXZ- ⁻³ 2D42VA2	MXZ- ⁻³ 2D53VA(H)2	MXZ- ⁻³ 2E53VAHZ	MXZ- ⁻³ 3E54VA	MXZ- ⁻³ 3E68VA	MXZ- ⁻³ 4E72VA	MXZ- ⁻³ 4E83VA	MXZ- ⁻³ 4E83VAHZ	MXZ- ⁻³ 5E102VA	MXZ- ⁻³ 6D122VA2	MXZ- ⁻³ 2DM40VA	MXZ- ⁻³ 3DM50VA	
M series	Wall-Mounted	MSZ-LN18VG(W)(V)(R)(B)													
		MSZ-LN25VG(W)(V)(R)(B)	●	●	●	●	●	●	●	●	●	●			
		MSZ-LN35VG(W)(V)(R)(B)		●	●	●	●	●	●	●	●	●			
		MSZ-LN50VG(W)(V)(R)(B)													
		MSZ-AP15VG ^{*7}	●	●	●	●	●	●	●	●	●	●	●		
		MSZ-AP20VG ^{*7}	●	●	●	●	●	●	●	●	●	●	●		
		MSZ-AP25VG ^{*7}	●	●	●	●	●	●	●	●	●	●	●		
		MSZ-AP35VG ^{*7}		●	●	●	●	●	●	●	●	●	●		
		MSZ-AP42VG ^{*7}			●	●	●	●	●	●	●	●	●		
		MSZ-AP50VG ^{*7}			●	●	●	●	●	●	●	●	●		
		MSZ-EF18VG(W)(B)(S)	●	●	●	●	●	●	●	●	●	●	●		
		MSZ-EF22VG(W)(B)(S)	●	●	●	●	●	●	●	●	●	●	●		
		MSZ-EF25VG(W)(B)(S)	●	●	●	●	●	●	●	●	●	●	●		
		MSZ-EF35VG(W)(B)(S)		●	●	●	●	●	●	●	●	●	●		
		MSZ-EF42VG(W)(B)(S)			●	●	●	●	●	●	●	●	●		
		MSZ-EF50VG(W)(B)(S)			●	●	●	●	●	●	●	●	●		
		MSZ-FH25VE2	●	●	●	●	●	●	●	●	●	●	●		
		MSZ-FH35VE2		●	●	●	●	●	●	●	●	●	●		
		MSZ-FH50VE2			●	●	●	●	●	●	●	●	●		
		MSZ-SF15VA	●	●	●	●	●	●	●	●	●	●	●		
		MSZ-SF20VA	●	●	●	●	●	●	●	●	●	●	●		
		MSZ-SF25VE3	●	●	●	●	●	●	●	●	●	●	●		
		MSZ-SF35VE3		●	●	●	●	●	●	●	●	●	●		
		MSZ-SF42VE3			●	●	●	●	●	●	●	●	●		
	MSZ-SF50VE3			●	●	●	●	●	●	●	●	●			
	MSZ-GF60VE2						●	●	●	●	●	●			
	MSZ-GF71VE2							●	●	●	●	●			
	MSZ-DM25VA												●	●	
	MSZ-DM35VA												●	●	
	MSZ-HJ25VA												●	●	
MSZ-HJ35VA												●	●		
MSZ-HJ50VA													●		
Floor-Standing	MFZ-KJ25VE2	● ^{*4*5}	● ^{*4}	● ^{*4}	●	● ^{*4}	● ^{*4}	●	●	●	●				
	MFZ-KJ35VE2		● ^{*4}	● ^{*4}	●	● ^{*4}	● ^{*4}	●	●	●	●				
	MFZ-KJ50VE2				●	● ^{*4}	● ^{*4}	●	●	●	●				
1-way Cassette	MLZ-KP25VF	●	●	●	●	●	●	●	●	●	●				
	MLZ-KP35VF		●	●	●	●	●	●	●	●	●				
	MLZ-KP50VF				●	●	●	●	●	●	●				
S series	2x2 Cassette	SLZ-M15FA													
		SLZ-M25FA	●	●	●	●	●	●	●	●	●	●			
		SLZ-M35FA		●	●	●	●	●	●	●	●	●			
		SLZ-M50FA				●	●	●	●	●	●	●			
	Ceiling-Concealed	SEZ-M25DA ^{*2}	●	●	●	●	●	●	●	●	●	●			
		SEZ-M25DAL ^{*2}	●	●	●	●	●	●	●	●	●	●			
		SEZ-M35DA		●	●	●	●	●	●	●	●	●			
		SEZ-M35DAL		●	●	●	●	●	●	●	●	●			
		SEZ-M50DA				●	●	●	●	●	●	●			
		SEZ-M50DAL				●	●	●	●	●	●	●			
		SEZ-M60DA					●	●	●	●	●	●			
		SEZ-M60DAL					●	●	●	●	●	●			
SEZ-M71DA							●	●	●	●					
SEZ-M71DAL							●	●	●	●					
P series	4-way Cassette	PLA-M50EA				●	●	●	●	● ^{*6}	●	●			
		PLA-M60EA					●	●	●	● ^{*6}	●	●			
		PLA-M71EA							●	● ^{*6}	●	●			
	Ceiling-Suspended	PCA-M50KA				●	●	●	●	● ^{*6}	●	●			
		PCA-M60KA					●	●	●	● ^{*6}	●	●			
		PCA-M71KA							●	● ^{*6}	●	●			
	Ceiling-Concealed	PEAD-M50JA					● ^{*1}	● ^{*1}	● ^{*1}	● ^{*1}	● ^{*1*6}	● ^{*1}	● ^{*1}		
		PEAD-M50JAL					● ^{*1}	● ^{*1}	● ^{*1}	● ^{*1}	● ^{*1*6}	● ^{*1}	● ^{*1}		
		PEAD-M60JA								● ^{*1}	● ^{*1*6}	● ^{*1}	● ^{*1}		
		PEAD-M60JAL								● ^{*1}	● ^{*1*6}	● ^{*1}	● ^{*1}		
								● ^{*1}	● ^{*1*6}	● ^{*1}	● ^{*1}				
								● ^{*1}	● ^{*1*6}	● ^{*1}	● ^{*1}				

^{*1} Maximum total current of indoor units: 3A or less.

^{*2} SEZ-KD25 cannot be connected with MXZ-2D(E)/3E/4E/5E when total capacity of connected indoor units is equivalent to outdoor capacity (capacity ratio is 1).

^{*3} MXZ outdoor units are not designed to operate with a single indoor unit with one-to-one piping work. Please install at least two indoor units.

^{*4} When connecting the MFZ-KJ Series indoor unit, additional refrigerant is required. For details, please refer to page 106.

^{*5} Regarding MXZ-2D33, the second unit should be a different type in the case of selecting one MFZ-KJ.

^{*6} P series cannot be connected with MXZ-4E83VAHZ when ampere limit adjustment function is operated.

^{*7} Connectable outdoor unit are MXZ-2D33VA-E4, MXZ-2D42VA2-E4, MXZ-2D53VA2-E4, MXZ-2E53VAHZ-E2, MXZ-3E54VA-E2, MXZ-3E68VA-E2, MXZ-4E72VA-E2, MXZ-4E83VA-E4, MXZ-4E83VAHZ-E3, MXZ-5E102VA-E4.

■ PUMY-SP Series

Branch Box Connection Compatibility Table for PUMY-SP112/125/140

Series	Type	Model Name	Capacity										
			15	18	20	22	25	35	42	50	60	71	100
M series	Wall-Mounted	MSZ-LN•VG2					●	●		●			
		MSZ-RW•VG-E					●	●		●			
		MSZ-AP•VG(K)	●		●		●	●	●	●			
		MSZ-FH•VE2					●	●		●			
		MSZ-EF•VG(K)		●		●	●	●	●	●			
		MSZ-SF•VA	●		●								
		MSZ-AP•VF-E	●		●								
		MSZ-SF•VE3					●	●	●	●			
	MSZ-GF•VE2									●	●		
	Floor-Standing	MFZ-KT•VG					●	●		●			
MFZ-KJ•VE-E						●	●		●				
1-way Cassette	MLZ-KP•VF					●	●		●				
	MLZ-KA•VA-E					●	●		●				
S series	Ceiling-Concealed	SEZ-M•DA(L)2					●*1	●*1		●*1	●*1	●*1	
		SEZ-KD•VA-E					●*1	●*1		●*1	●*1	●*1	
	2x2 Cassette	SLZ-M•FA(2)	●*1				●*1	●*1		●*1			
		SLZ-KF•VA-E					●*1	●*1		●*1			
P series	Ceiling-Suspended	PCA-M•KA(2)						●*1		●*1	●*1	●*1	●*1
		PCA-RP•KAQ-E						●*1		●*1	●*1	●*1	●*1
	4-way Cassette	PLA-M•EA(2)						●*1		●*1	●*1	●*1	●*1
		PLA-RP•EA-E						●*1		●*1	●*1	●*1	●*1
	Ceiling-Concealed	PEAD-M•JA(L)2								●*1	●*1	●*1	●*1
		PEAD-RP•JAQ(L)-E								●*1	●*1	●*1	●*1

*1 Some functions that can be used by connecting to the P series outdoor unit cannot be used with the PUMY series.

LEV Kit Connection Compatibility Table for PUMY-SP112/125/140

Series	I/U Type	Model Name	Capacity										
			15	18	20	22	25	35	42	50	60	71	
M series	Wall-Mounted	MSZ-LN•VG2					●	●		●			
		MSZ-AP•VG(K)	●		●		●	●	●	●			
		MSZ-FH•VE2					●	●		●			
		MSZ-EF•VG(K)		●		●	●	●	●	●			
		MSZ-SF•VA	●		●								
		MSZ-AP•VF-E	●		●								
		MSZ-SF•VE3					●	●	●	●			
	Floor-Standing	MFZ-KT•VG					●	●		●			

CITY MULTI Indoor Unit Compatibility Table for PUMY-SP112/125/140

Series	Type	Model Name	Capacity													
			P10	P15	P20	P25	P32	P40	P50	P63	P71	P80	P100	P125	P140	P200
CITY MULTI series	1-way cassette	PMFY-P•VBM-E			●	●	●	●								
		PLFY-P•VLM-E			●	●	●	●								
	2-way cassette	PLFY-M•VEM-E			●	●	●	●								
		PLFY-M•VEM6-E			●	●	●	●			●					
	4-way cassette	PLFY-P•VBM-E			●	●	●	●								
		PLFY-P•VEM-E			●	●	●	●								
		PLFY-P•VCM-E		●		●	●	●								
		PLFY-P•VFM-E		●		●	●	●								
		PEFY-P•VMR-E-L/R			●	●	●	●								
		PEFY-P•VMS1(L)-E		●		●	●	●								
	Ceiling-concealed	PLFY-P•VMA(L)-E			●	●	●	●								
		PEFY-M•VMA(L)-A(1)			●	●	●	●			●	●	●	●	●	●
		PEFY-P•VMH(S)-E						●			●	●	●	●	●	●
		PEFY-P•VMH-E-F										●			●	●
		PEFY-P•VMHS-E-F												●	●	
		PCFY-P•VKM-E	●						●		●			●	●	
	Ceiling-suspended	PKFY-P•VLM-E	●					●		●						
		PKFY-P•VBM-E		●		●	●									
		PKFY-P•VHM-E						●		●						
		PKFY-P•VKM-E									●			●		
	Wall-mounted	PDFY-P•VM-E			●	●	●	●								
		PDFY-P•VM-E			●	●	●	●								
	Built in	PDFY-P•VM-E			●	●	●	●								
		PDFY-P•VM-E			●	●	●	●								
		PDFY-P•VLRM-E			●	●	●	●								
		PDFY-P•VLRMM-E			●	●	●	●								
		PDFY-P•VCM-E			●	●	●	●								
Floor-standing	PFFY-P•VKM-E2			●	●	●	●									
	PFFY-P•VLEM-E			●	●	●	●									
	PFFY-P•VLRM-E			●	●	●	●									
	PFFY-P•VLRMM-E			●	●	●	●									
	PFFY-P•VCM-E			●	●	●	●									
Lossnay *1															GUF-50/100RD(H)4	

*1 Do not connect Lossnay remote controller(s). (PZ-61DR-E, PZ-60DR-E, PZ-52SF-E, PZ-43SMF-E)

■ PUMY-P Series

Branch Box Connection Compatibility Table for PUMY-P112/125/140/200

Series	Type	Model Name	Capacity										
			15	18	20	22	25	35	42	50	60	71	100
M series	Wall-Mounted	MSZ-LN•VG2					●	●	●	●	●		
		MSZ-AP•VG(K)	●		●		●	●	●	●	●		
		MSZ-AY•VG(K)					●	●	●	●	●		
		MSZ-FH•VE2					●	●	●	●	●		
		MSZ-EF•VE		●		●	●	●	●	●	●		
		MSZ-EF•VG(K)		●		●	●	●	●	●	●		
		MSZ-SF•VA	●		●								
		MSZ-AP•VF	●		●								
		MSZ-SF•VE3					●	●	●	●			
		MSZ-GF•VE2										●	●
Floor-Standing	MFZ-KT•VG					●	●	●	●				
	MFZ-KJ•VE-E					●	●	●	●				
1-way Cassette	MLZ-KP•VF					●	●	●	●				
	MLZ-KA•VA-E					●	●	●	●				
S series	Ceiling-Concealed	SEZ-M•DA(L)					●	●	●	●	●	●	
		SEZ-KD•VA-E					●	●	●	●	●	●	
		SEZ-M•DA(L)2-E					●	●	●	●	●	●	
	2x2 Cassette	SLZ-M•FA(2)	●				●	●	●	●			
SLZ-KF•VA-E						●	●	●	●				
P series	Ceiling-Suspended	PCA-M•KA(2)					●	●	●	●	●	●	●
		PCA-RP•KAQ-E					●	●	●	●	●	●	●
	4-way Cassette	PLA-M•EA(2)					●	●	●	●	●	●	●
		PLA-RP•EA-E					●	●	●	●	●	●	●
	Ceiling-Concealed	PEAD-M•JA(L)					●	●	●	●	●	●	●
		PEAD-RP•JA(L)Q-E					●	●	●	●	●	●	●
PEAD-M•DAL)2									●	●	●	●	

LEV Kit Connection Compatibility Table for PUMY-P112/125/140/200

Series	I/U Type	Model Name	Capacity										
			15	18	20	22	25	35	42	50	60	71	
M series	Wall-Mounted	MSZ-LN•VG2					●	●	●	●	●		
		MSZ-AP•VG(K)	●		●		●	●	●	●	●		
		MSZ-AY•VG(K)					●	●	●	●	●		
		MSZ-FH•VE2					●	●	●	●	●		
		MSZ-EF•VG(K)		●		●	●	●	●	●	●		
		MSZ-SF•VA	●		●								
		MSZ-SF•VE3					●	●	●	●	●		
Floor-Standing	MFZ-KT•VG					●	●	●	●				

CITY MULTI Indoor Unit Compatibility Table for PUMY-P112/125/140

Series	Type	Model Name	Capacity													
			P10	P15	P20	P25	P32	P40	P50	P63	P71	P80	P100	P125	P140	P200
CITY MULTI series	1-way cassette	PMFY-P•VBM-E			●	●	●	●								
		2-way cassette			●	●	●	●	●	●		●	●	●		
		4-way cassette			●	●	●	●	●	●	●		●	●		
	Ceiling-concealed	PLFY-M•VEM-E			●	●	●	●	●	●						
		PLFY-M•VEM6-E			●	●	●	●	●	●	●					
		PLFY-P•VFM-E		●	●	●	●	●	●	●						
		PEFY-P•VMR-E-L/R			●	●	●	●	●	●						
		PEFY-P•VMS1(L)-E		●	●	●	●	●	●	●						
		PEFY-M•VMA(L)-A(1)			●	●	●	●	●	●	●	●	●	●	●	
	Ceiling-suspended	PEFY-P•VMHS-E							●	●	●	●	●	●	●	
		PEFY-P•VMHS-E-F												●	●	
		PCFY-P•VKM-E							●	●				●	●	
	Wall-mounted	PKFY-P•VLM-E	●	●	●	●	●	●	●					●		
		PKFY-P•VKM-E								●				●		
	Floor-standing	PFFY-P•VKM-E2			●	●	●	●	●							
		PFFY-P•VLEM-E			●	●	●	●	●	●	●					
		PFFY-P•VLRM-E			●	●	●	●	●	●	●					
		PFFY-P•VLRMM-E			●	●	●	●	●	●	●					
PFFY-P•VCM-E				●	●	●	●	●	●	●						
ATW	PWFY-P•VM-E1 *1												●			
Lossnay *2		GUF-50/100RD(H)4														

CITY MULTI Indoor Unit Compatibility Table for PUMY-P200

Series	Type	Model Name	Capacity													
			P10	P15	P20	P25	P32	P40	P50	P63	P71	P80	P100	P125	P140	P200
CITY MULTI series	1-way cassette	PMFY-P•VBM-E			●	●	●	●								
		2-way cassette			●	●	●	●	●	●		●	●	●		
		4-way cassette			●	●	●	●	●	●	●		●	●		
	Ceiling-concealed	PLFY-M•VEM-E			●	●	●	●	●	●						
		PLFY-M•VEM6-E			●	●	●	●	●	●	●					
		PLFY-P•VFM-E		●	●	●	●	●	●	●						
		PEFY-P•VMR-E-L/R			●	●	●	●	●	●						
		PEFY-M•VMA(L)-A(1)			●	●	●	●	●	●	●	●	●	●	●	
		PEFY-P•VMHS-E							●	●	●	●	●	●	●	●
	Ceiling-suspended	PEFY-P•VMHS-E-F													●	
		PCFY-P•VKM-E							●	●				●	●	
		PKFY-P•VLM-E	●	●	●	●	●	●	●						●	
	Wall-mounted	PKFY-P•VKM-E								●				●		
		PKFY-P•VKM-E									●				●	
	Floor-standing	PFFY-P•VKM-E2			●	●	●	●	●							
		PFFY-P•VLEM-E			●	●	●	●	●	●	●					
		PFFY-P•VLRM-E			●	●	●	●	●	●	●					
		PFFY-P•VLRMM-E			●	●	●	●	●	●	●					
PFFY-P•VCM-E				●	●	●	●	●	●	●						
Lossnay *2		GUF-50/100RD(H)4														

*1 Note that connection is not allowed inside EU countries and UK. PWFY can not connect to PUMY-P200YKM3.

*2 Do not connect Lossnay remote controller(s). (PZ-61DR-E, PZ-60DR-E, PZ-52SF-E, PZ-43SMF-E)

■ PUMY-P Series

Branch Box Connection Compatibility Table for PUMY-P250/300

Series	Type	Model Name	Capacity										
			15	18	20	22	25	35	42	50	60	71	100
M series	Wall-Mounted	MSZ-LN•VG2					●	●		●			
		MSZ-RW•VG-E					●	●		●			
		MSZ-AP•VG(K)	●		●		●	●	●	●			
		MSZ-FH•VE2					●	●		●			
	MSZ-EF•VG(K)		●		●	●	●	●	●				
	Floor-Standing	MSZ-KT•VG					●	●		●			
S series	Ceiling Concealed	SEZ-M•DA(L)2					●	●		●	●	●	
	2×2 Cassette	SLZ-M•FA2	●				●	●		●			
P series	Ceiling Suspended	PCA-M•KA2						●		●	●	●	●
	4-way Cassette	PCA-M•EA2						●		●	●	●	●
	Ceiling Concealed	PEAD-M•JA(2)								●	●	●	●

LEV Kit Connection Compatibility Table for PUMY-P250/300

Series	I/U Type	Model Name	Capacity							
			15	18	20	22	25	35	42	50
M series	Wall-Mounted	MSZ-LN•VG2					●	●		●
		MSZ-AP•VG(K)	●		●		●	●	●	
		MSZ-FH•VE2					●	●		●
	MSZ-EF•VG(K)		●		●	●	●	●		
	Floor-Standing	MFZ-KT•VG					●	●		●

CITY MULTI Indoor Unit Compatibility Table for PUMY-P250/300

Series	Type	Model Name	Capacity														
			P10	P15	P20	P25	P32	P40	P50	P63	P71	P80	P100	P125	P140	P200	P250
CITY MULTI series	1-way cassette	PMFY-P•VBM-E			●	●	●	●									
	2-way cassette	PLFY-P•VLM-D-E			●	●	●	●	●	●		●	●	●			
	4-way cassette	PLFY-M•VEM-E			●	●	●	●	●	●		●	●	●			
		PLFY-M•VEM6-E			●	●	●	●	●	●	●	●	●	●			
		PLFY-P•VFM-E		●	●	●	●	●	●	●							
	Ceiling-concealed	PEFY-P•VMR-E-L/R			●	●	●	●									
		PEFY-P•VMS1(L)-E		●	●	●	●	●	●	●							
		PEFY-M•VMA(L)-A			●	●	●	●	●	●	●	●	●	●	●		
		PEFY-P•VMA(L)-A1			●	●	●	●	●	●	●	●	●	●	●	●	
		PEFY-P•VMHS-E							●	●	●	●	●	●	●	●	●
		PEFY-P•VMHS-E-F															●
	Ceiling-suspended	PCFY-P•VKM-E							●		●		●	●			
	Wall-mounted	PKFY-P•VLM-E	●	●	●	●	●	●	●								
		PKFY-P•VKM-E								●				●			
	Floor-standing	PFFY-P•VKM-E2			●	●	●	●									
		PFFY-P•VLEM-E			●	●	●	●	●	●							
		PFFY-P•VCM-E			●	●	●	●	●	●	●						
Lossnay *1		GUF-50/100RD(H)4															

*1 Do not connect Lossnay remote controller(s). (PZ-61DR-E, PZ-60DR-E, PZ-52SF-E, PZ-43SMF-E)



POWERFUL HEATING





SERIES

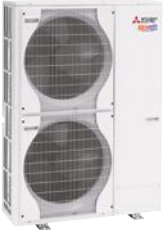

SELECTION

Choose the series that best matches the building layout.

MSZ-LN VGHZ, MSZ-FH/MFZ-KJ VEHZ SERIES	
The line-up includes outdoor models 25-50	
<p>Outdoor Unit</p> <div style="display: flex; justify-content: space-around;"> <div style="text-align: center;">  <p>MUZ-LN25/35VGHZ2 MUZ-FT25VGHZ</p> </div> <div style="text-align: center;">  <p>MUZ-RW25/35VGHZ</p> </div> </div> <div style="display: flex; justify-content: space-around; margin-top: 20px;"> <div style="text-align: center;">  <p>MUFZ-KW25/35VGHZ</p> </div> </div> <div style="display: flex; justify-content: space-around; margin-top: 20px;"> <div style="text-align: center;">  <p>MUZ-RW50VGHZ MUZ-LN50VGHZ2</p> </div> <div style="text-align: center;">  <p>MUFZ-KW50/60VGHZ</p> </div> </div>	<p>Indoor Unit</p> <p>Wall-mounted</p> <div style="display: flex; justify-content: space-around;"> <div style="text-align: center;">  <p>MSZ-RW25/35/50VG</p> </div> <div style="text-align: center;">  <p>MSZ-LN25/35/50VG2 (W)(V)(R)(B)</p> </div> </div> <div style="text-align: center; margin-top: 20px;">  <p>MSZ-FT25/35/50VG</p> </div> <p>Floor-standing</p> <div style="text-align: center;">  <p>MFZ-KW25/35/50/60VG</p> </div>
* R410A is for PUMY connection.	

ZUBADAN SERIES	
The line-up includes outdoor unit models 112-140 class and three types of indoor units.	
<p>Outdoor Unit</p> <div style="text-align: center;">  <p>PUHZ-SHW112VHA PUHZ-SHW112/140YHA</p> </div>	<p>Indoor Unit</p> <div style="display: flex; justify-content: space-between;"> <div style="width: 30%;"> <p>4-way cassette</p> <div style="text-align: center;">  <p>PLA Series</p> </div> </div> <div style="width: 30%;"> <p>Ceiling-concealed</p> <div style="text-align: center;">  <p>PEAD Series</p> </div> </div> <div style="width: 30%;"> <p>Wall-mounted</p> <div style="text-align: center;">  <p>PKA Series</p> </div> </div> </div>

MXZ-VAHZ/VFHZ SERIES	
<p>Outdoor Unit</p> <div style="display: flex; justify-content: space-around; margin-top: 20px;"> <div style="text-align: center;">  <p>MXZ-2F53VFHZ2</p> </div> <div style="text-align: center;">  <p>MXZ-4F83VFHZ2</p> </div> </div>	

MSZ-RW SERIES

R32 Single / MXZ, PUMY R410A PUMY

As a flagship model, RW series realises further outstanding heating performances under extremely cold outdoor temperature even with high energy efficiency. Moreover, excellent air purifying functions and many other smart features deliver a great comfort to you.



MSZ-RW25/35/50VG

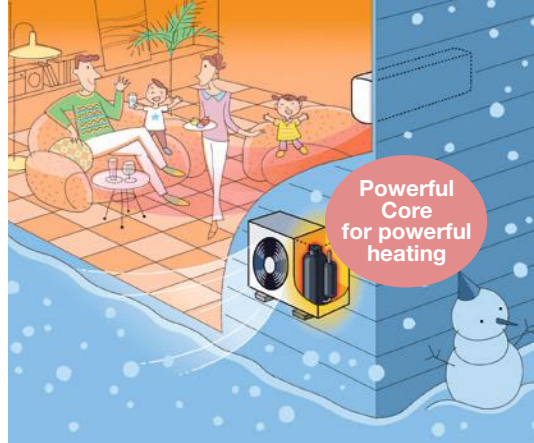

Heating Performance

Excellent heating performance of RW series delivers the prime warmth into your room. RW series' powerful compressor realises remarkable maximum heating capacity in low ambient temperature with a high energy efficiency. Also, RW series performs 100% rated capacity even at -25°C, and the operation is guaranteed down to -30°C for all classes (25/35/50).

High Energy Efficiency

RW25	A+++	SCOP 5.2
RW35	A+++	SCOP 5.1
RW50	A++	SCOP 4.6

Improved Heating Capacity

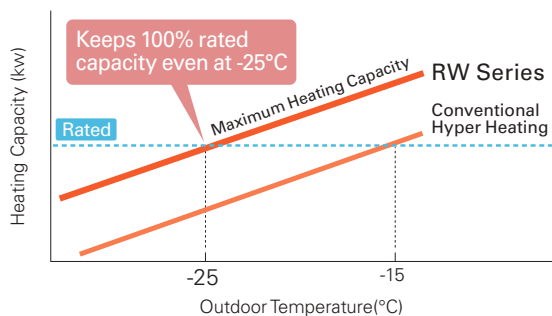

Wider Heating Operation Range

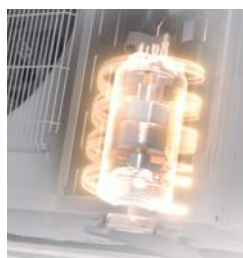
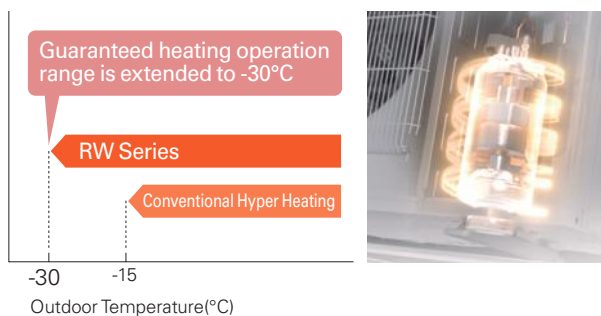

Longer Continuous Heating Operation

RW series with a high frost-detecting technology, made it possible to provide maximum continuous heating operation as long as 150 minutes with less frequent defrosting operations, maintaining a comfortable indoor environment in a long term.

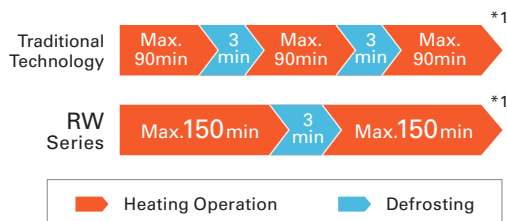

*1 The time for heating and defrosting operation depends on the environmental conditions.

Tested in Sweden and Norway

We have conducted field tests in several cold sites and received high user satisfactions with sufficient air volume and remarkable heating performance of RW series. As the test result shows, we confirmed that RW series provides stable indoor comfortability even in extremely low ambient temperature.

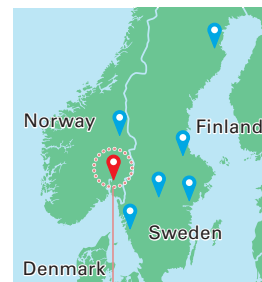

Test result in Norway

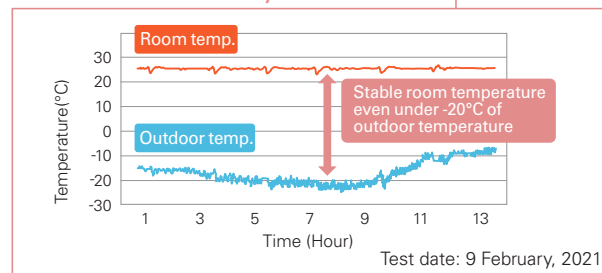

3D i-see Sensor

3D i-see sensor with the sophisticated hemispherical design measures the temperature of the room with an infrared sensor and detects the position of people, which allows you to choose your preferable airflow such as indirect and direct airflow.



Circulator Mode

In heating mode, after reaching the setting temperature, indoor unit automatically starts FAN mode to circulate the air and eliminate temperature unevenness in your room.



Plasma Quad Plus

Plasma Quad Plus is a plasma-based filtering system which contributes to a better air quality in your room. Plasma Quad Plus applies a voltage of approximately 6,000 volts to the electrode to generate plasma, effectively removing various kinds of airborne particles such as viruses, bacteria, mold, allergen, dust, and PM2.5.

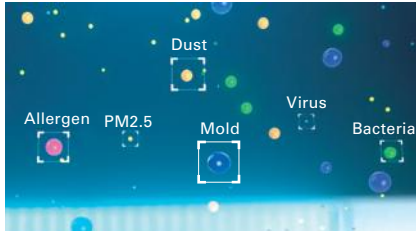

*Images are for illustration purposes.

Virus (Airborne)

99% inhibited*1

*1 Tested Organization: vrc. Center, SMC Test Report No: 28-002 Test Method: JEM1467 Test result: Neutralised 99% of Influenza A virus in 72 minutes in a 25m³ test space.

*2 Tested Organization: Japan Textile Products Quality and Technology Center, Test Report No: 20KB070569, Tested Materials: SARS-CoV-2, Test Method: Original (The test was conducted on the Plasma Quad device alone, not designed to evaluate product performance.) Test Result: Inhibited 99.8% in 360 minutes. The result without the effect of natural attenuation is 96.3%.

We have confirmed Plasma Quad Plus inhibits 99.8% of adhered COVID-19. *2

Quick Air Purifying Set

If you press "PURIFIER" button when the unit is turned off, Plasma Quad Plus starts to operate with a fan mode and purifies the air in your room.

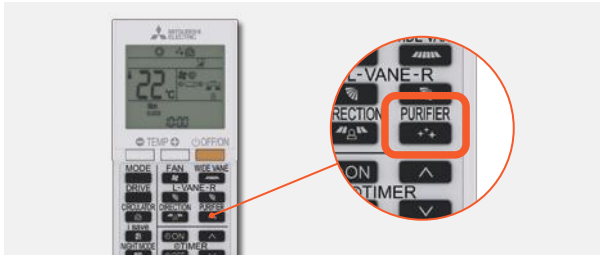

Deodorising Filter

The catalyst in Deodorising Filter denatures the odorous components and destroys them from the source of the odour, quickly delivering fresh air to your room.



Dual Barrier Coating

SIAA *1
Anti Fungus
JP0512075X0001C
(Fan, Air duct)

Mitsubishi Electric's Dual Barrier Coating prevents dust and greasy dirt from accumulating on the inner surface of the indoor unit; keeping your air conditioner clean. Two barrier coating prevents hydrophilic dirt penetration, and "hydrophilic particles" prevent hydrophobic dirt from getting into the air conditioner.

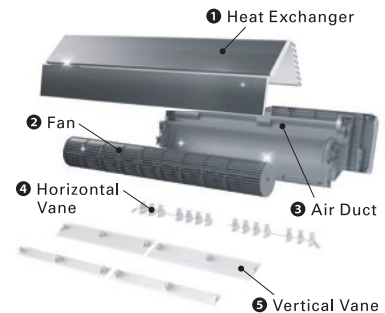
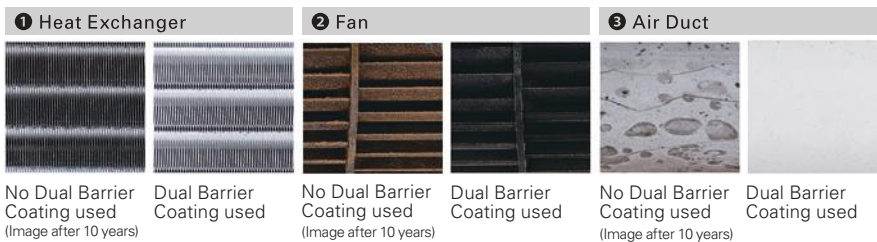

Dual Barrier Material

SIAA *2
Anti Fungus
JP0512075X0001C
(Horizontal Vane, Vertical Vane)

Dual Barrier Material performs the same antifouling effect as Dual Barrier Coating, and it is kneaded into horizontal vane and vertical vane material which are hard to apply coating to. Combined with Dual Barrier Coating, the whole air passage of indoor unit is kept clean all year round.

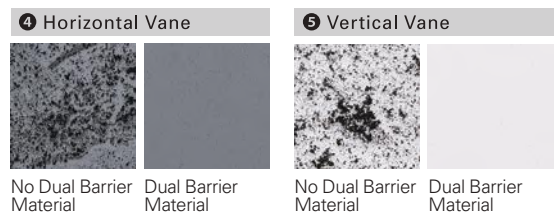

*Comparison of stains after 10 years of use (based on internal research)

*1 *2 Verified by SIAA test method (JIS Z 2911) with No. JP0501014A00020 on SIAA antifungal agent positive list. Antifungal effect depends on the working environment. Fungicides comply with the SIAA safety criteria. What is SIAA? https://www.kohkin.net/en_index.html

Drive Mode Selector

Drive Mode Selector allows you to select a preferred control setting according to your residential environment from three modes, Wide Room mode, Quiet mode, and Eco mode.

Wide Room Mode

Provides a better air distribution in your room and raises the comfort level.

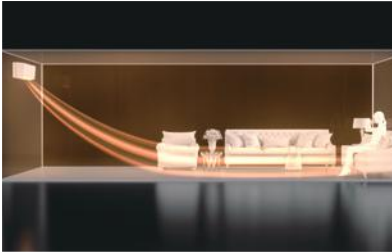

Eco Mode

Suppresses a sharp increase in energy consumption by a gradual start-up operation.

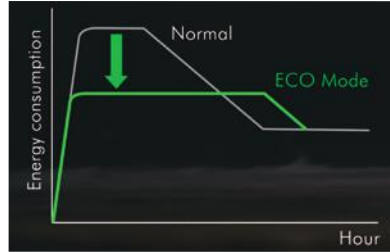

Quiet Mode

Lowers operation noise level, creating a quieter and peaceful environment.



Built-in Wi-Fi & App Control

Indoor unit is equipped with Wi-Fi interface which allows you to access MELCloud app, providing you with a flexible control of air conditioner on your smartphone, tablets, and PC.



Easy Wi-Fi Set Up

You can easily connect Wi-Fi adaptor in the indoor unit and your local router with just a simple operation of remote controller.

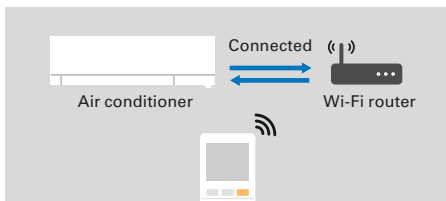

Remote Controller with Backlight

The remote controller screen is equipped with LED backlight. The luminous screen allows you to check the setting easily even in the dark.



Back Plate with a Hole

With a hole as default in the center of the back plate, the piping can be easily taken out from the back. The edge of the hole is reinforced to ensure the strength.



The edge of the hole is reinforced to ensure the strength.

Spacer

A part of the packing material can be used as a spacer to lift indoor unit during the left-side piping work, which makes stable installation work possible.



Bottom Removable Structure

The corner box and the bottom panel are individually removable, and it makes easy to insert tools even in the case of left-side piping.

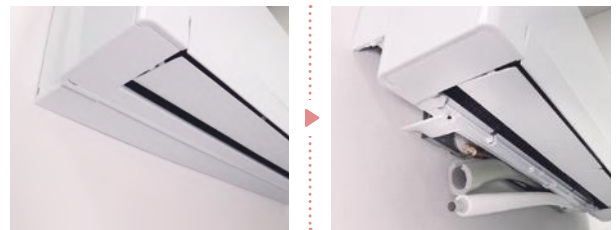

Easy Plugging/Unplugging of Drain Hose

One-touch structure with screw-free claw fixing. Easy to plug and unplug the drain hose when changing on the left and right.



MSZ-RW SERIES



Indoor Unit / Remote Controller

<White>

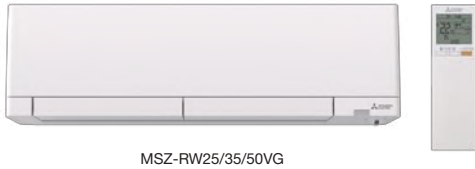

MSZ-RW25/35/50VG

Outdoor Unit



MUZ-RW25/35VGHZ



MUZ-RW50VGHZ

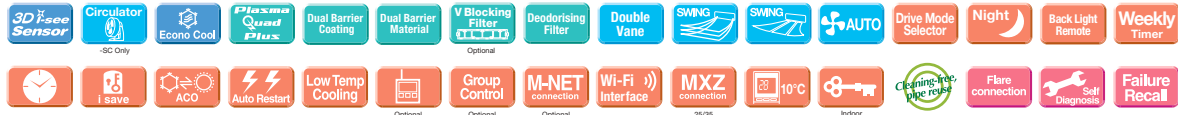

Type		Inverter Heat Pump				
Indoor Unit		MSZ-RW25VG	MSZ-RW35VG	MSZ-RW50VG		
Outdoor Unit		MUZ-RW25VGHZ	MUZ-RW35VGHZ	MUZ-RW50VGHZ		
Refrigerant		R32 ^{(*)1}				
Power Supply		Outdoor Power supply				
Source		230/Single/50				
Outdoor (V/Phase/Hz)						
Cooling	Design Load	kW	2.5	3.5	5.0	
	Annual Electricity Consumption ^{(*)2}	kWh/a	78	130	230	
	SEER ^{(*)4}	Energy Efficiency Class		11.2	9.4	7.6
				A+++	A+++	A++
	Capacity	Rated	kW	2.5	3.5	5.0
		Min - Max	kW	0.9 - 3.5	1.0 - 4.0	1.4 - 5.8
	Total Input	Rated	kW	0.435	0.770	1.380
Heating (Average Season) ^{(*)5}	Design Load	kW	3.2	4.0	6.0	
	Declared Capacity	at reference design temperature	kW	3.2 (-10°C)	4.0 (-10°C)	6.0 (-10°C)
		at bivalent temperature	kW	3.2 (-10°C)	4.0 (-10°C)	6.0 (-10°C)
		at operation limit temperature	kW	2.6 (-25°C)	2.6 (-25°C)	4.0 (-25°C)
	Back Up Heating Capacity	kW	0.0	0.0	0.0	
	Annual Electricity Consumption ^{(*)2}	kWh/a	856	1097	1800	
	SCOP ^{(*)4}	Energy Efficiency Class		5.2	5.1	4.6
				A+++	A+++	A++
Capacity	Rated	kW	3.2	4.0	6.0	
	Min - Max	kW	0.8 - 6.3	1.1 - 7.0	1.8 - 8.7	
Total Input	Rated	kW	0.580	0.810	1.450	
Operating Current (max)		A	9.8	11.2	15.2	
Indoor Unit	Input	Rated	kW	0.021	0.022	0.041
	Operating Current (max)		A	0.21	0.22	0.37
	Dimensions		H x W x D	mm	305 - 998 - 247	305 - 998 - 247
	Weight		kg	14.5	14.5	14.5
	Air Volume (SLo-Lo-Mid-Hi-SHi ^{(*)3})	Cooling	m ³ /min	5.1 - 6.5 - 9.0 - 11.5 - 13.7	5.1 - 6.9 - 9.0 - 11.5 - 14.1	7.8 - 9.5 - 11.1 - 13.1 - 16.2
		Heating	m ³ /min	5.1 - 7.8 - 9.5 - 11.7 - 14.1	5.1 - 7.8 - 9.5 - 11.7 - 14.5	7.8 - 10.7 - 12.5 - 14.7 - 18.2
	Sound Level (SPL) (SLo-Lo-Mid-Hi-SHi ^{(*)3})	Cooling	dB(A)	19 - 23 - 29 - 36 - 42	19 - 24 - 29 - 36 - 43	26 - 30 - 34 - 39 - 45
		Heating	dB(A)	19 - 25 - 30 - 36 - 41	19 - 25 - 30 - 36 - 42	25 - 32 - 37 - 41 - 46
	Sound Level (PWL)		dB(A)	58	59	59
	Dimensions		H x W x D	mm	714 - 800 - 285	880 - 840 - 330
Weight		kg	39.5	40	54	
Air Volume	Cooling	m ³ /min	35.1	37.8	49.3	
	Heating	m ³ /min	37.8	37.8	55.6	
Sound Level (SPL)	Cooling	dB(A)	46	49	51	
	Heating	dB(A)	49	50	54	
Sound Level (PWL)		dB(A)	60	61	64	
Operating Current (max)		A	9.6	11.0	14.8	
Breaker Size		A	10	12	16	
Ext. Piping	Diameter		Liquid / Gas	mm	6.35/9.52	6.35/9.52
	Max. Length		Out-In	m	20	30
	Max. Height		Out-In	m	12	15
Guaranteed Operating Range [Outdoor]		Cooling	°C	-10 ~ +46	-10 ~ +46	
		Heating	°C	-30 ~ +24	-30 ~ +24	

(*)1 Refrigerant leakage contributes to climate change. Refrigerant with lower global warming potential (GWP) would contribute less to global warming than a refrigerant with higher GWP, if leaked to the atmosphere. This appliance contains a refrigerant fluid with a GWP equal to 675. This means that if 1 kg of this refrigerant fluid would be leaked to the atmosphere, the impact on global warming would be 1975 times higher than 1 kg of CO₂ over a period of 100 years. Never try to interfere with the refrigerant circuit yourself or disassemble the product yourself and always ask a professional.

(*)2 Energy consumption based on standard test results. Actual energy consumption will depend on how the appliance is used and where it is located.

(*)3 SHi: Super High

(*)4 SEER, SCOP and other related description are based on COMMISSION DELEGATED REGULATION (EU) No.626/2011. The temperature conditions for calculating SCOP are based on "Average Season".

(*)5 Please see page 53-55 for heating (warmer season) specifications.

LN VGHZ SERIES

R32 Single / MXZ, PUMY R410A PUMY

Unlike conventional air conditioning systems, the LN Series don't lose heating capacity when it's cold outside. Original technologies ensure excellent heating performance under extremely low outdoor temperatures and an impressive guaranteed operating range.

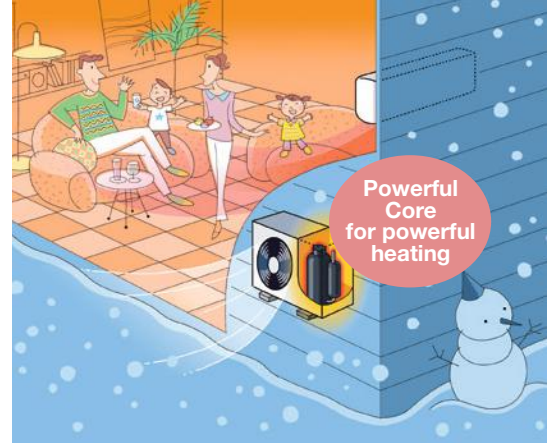

MSZ-LN25/35/50VG2(W)(V)(R)(B)

Unparalleled Heating Performance

LN Series outdoor units are equipped with a high-output compressor that provides enhanced heating performance under low outdoor temperatures. The heating operation range is extended down to -25°C.

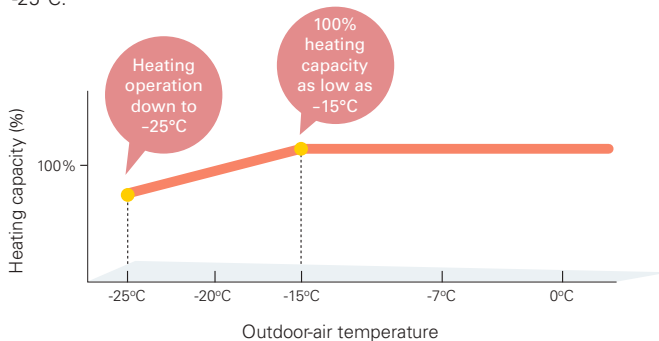

Operating Range

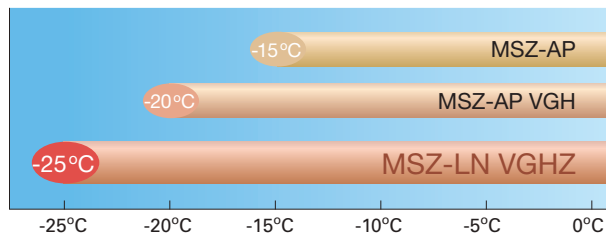

Declared Capacity (at reference design temperature)

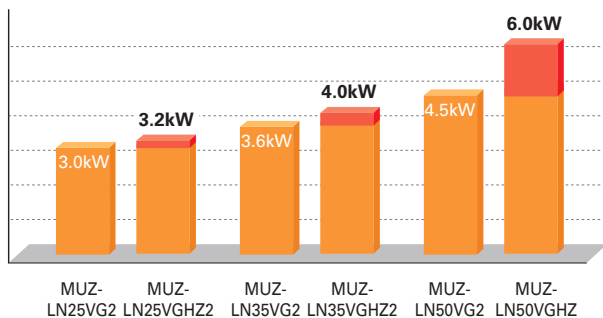

High Energy Efficiency – Energy Rank of A+ or higher for All Models



With indoor units that combine functionality, design and capacity and outdoor units equipped with a high-efficiency compressor, the MUZ-LN VGHZ simultaneously achieves high heating capacity and energy-saving performance.

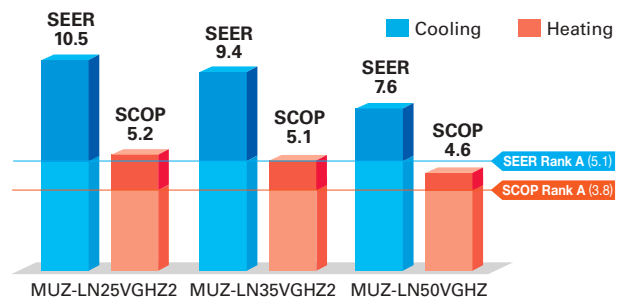

Freeze-prevention Heater Equipped as Standard

The Freeze-prevention heater restricts lowered capacity and operation shutdowns caused by the drain water freezing. This supports stable operation in low-temperature environments.

Operation Guaranteed at Outside Temperature of -25°C



Without Freeze-prevention heater



With Freeze-prevention heater

Compact, Powerful Compressor

A special manufacturing technology, "Heat Caulking Fixing Method," has been introduced to reduce compressor size while maintaining a high compressor output. This technology enables the installation of a powerful compressor in compact MUZ outdoor units. As a result, excellent heating performance is achieved when operating in cold outdoor environments.

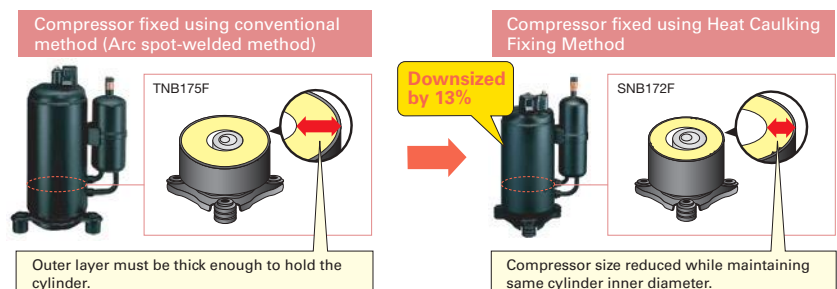

MSZ-LN VGHZ SERIES



Indoor Unit / Remote Controller



<Pearl White>



MSZ-LN25/35/50VG2V

<Ruby Red>



MSZ-LN25/35/50VG2R

<Natural White>



MSZ-LN25/35/50VG2W

<Onyx Black>



MSZ-LN25/35/50VG2B

Outdoor Unit



MUZ-LN25/35VGHZ2



MUZ-LN50VGHZ2

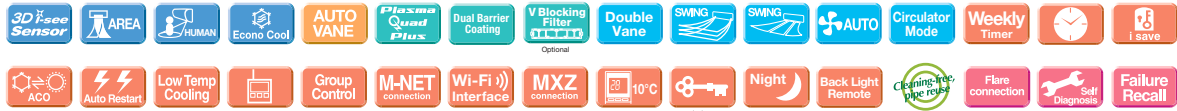

Type		Inverter Heat Pump				
Indoor Unit		MSZ-LN25VG2(W)(V)(R)(B)	MSZ-LN35VG2(W)(V)(R)(B)	MSZ-LN50VG2(W)(V)(R)(B)		
Outdoor Unit		MUZ-LN25VGHZ2	MUZ-LN35VGHZ2	MUZ-LN50VGHZ2		
Refrigerant		R32 ^{(*)1}				
Power Supply		Outdoor Power supply				
Source		230/Single/50				
Outdoor (V/Phase/Hz)						
Cooling	Design Load	kW	2.5	3.5	5.0	
	Annual Electricity Consumption ^{(*)2}	kWh/a	83	130	230	
	SEER ^{(*)4}	Energy Efficiency Class		10.5	9.4	7.6
				A+++	A+++	A++
	Capacity	Rated	kW	2.5	3.5	5.0
		Min - Max	kW	0.8 - 3.5	0.8 - 4.0	1.4 - 5.8
	Total Input	Rated	kW	0.485	0.820	1.380
Heating (Average Season) ^{(*)5}	Design Load	kW	3.2 (-10°C)	4.0 (-10°C)	6.0 (-10°C)	
	Declared Capacity	at reference design temperature	kW	3.2 (-10°C)	4.0 (-10°C)	6.0 (-10°C)
		at bivalent temperature	kW	3.2 (-10°C)	4.0 (-10°C)	6.0 (-10°C)
		at operation limit temperature	kW	2.3 (-25°C)	3.1 (-25°C)	4.7 (-25°C)
	Back Up Heating Capacity	kW	0.0 (-10°C)	0.0 (-10°C)	0.0 (-10°C)	
	Annual Electricity Consumption ^{(*)2}	kWh/a	861	1098	1826	
	SCOP ^{(*)4}	Energy Efficiency Class		5.2	5.1	4.6
				A+++	A+++	A++
	Capacity	Rated	kW	3.2	4.0	6.0
		Min - Max	kW	0.8 - 6.3	0.9 - 6.6	1.8 - 8.7
Total Input	Rated	kW	0.600	0.820	1.480	
Operating Current (max)		A	9.9	10.5	15.2	
Indoor Unit	Input	Rated	kW	0.027	0.027	0.034
	Operating Current (max)		A	0.3	0.3	0.4
	Dimensions		H x W x D	mm	307 - 890 - 233	307 - 890 - 233
	Weight		kg	15.5	15.5	15.5
	Air Volume (SLo-Lo-Mid-Hi-SHi ^{(*)3})	Cooling	m ³ /min	4.3 - 5.8 - 7.1 - 8.8 - 11.9	4.3 - 5.8 - 7.1 - 8.8 - 12.8	5.7 - 7.6 - 8.9 - 10.6 - 13.9
		Heating	m ³ /min	4.0 - 5.7 - 7.1 - 8.5 - 14.4	4.3 - 5.7 - 7.1 - 8.5 - 13.7	5.4 - 6.4 - 8.5 - 10.7 - 15.7
	Sound Level (SPL) (SLo-Lo-Mid-Hi-SHi ^{(*)3})	Cooling	dB(A)	19 - 23 - 29 - 36 - 42	19 - 24 - 29 - 36 - 43	27 - 31 - 35 - 39 - 46
		Heating	dB(A)	19 - 24 - 29 - 36 - 45	19 - 24 - 29 - 36 - 45	25 - 29 - 34 - 39 - 47
	Sound Level (PWL)		dB(A)	58	58	60
	Outdoor Unit	Dimensions		H x W x D	mm	550 - 800 - 285
Weight		kg	35	36		
Air Volume		Cooling	m ³ /min	31.4	33.8	48.8
		Heating	m ³ /min	27.4	27.4	55.0
Sound Level (SPL)		Cooling	dB(A)	46	49	51
		Heating	dB(A)	49	50	54
Sound Level (PWL)		dB(A)	60	61	64	
Operating Current (max)		A	9.6	10.2	14.8	
Breaker Size		A	10	12	16	
Ext. Piping	Diameter		Liquid / Gas	mm	6.35/9.52	
	Max. Length		Out-In	m	20	
	Max. Height		Out-In	m	12	
Guaranteed Operating Range [Outdoor]		Cooling	°C	-10 ~ +46	-10 ~ +46	
		Heating	°C	-25 ~ +24	-25 ~ +24	

(*)1 Refrigerant leakage contributes to climate change. Refrigerant with lower global warming potential (GWP) would contribute less to global warming than a refrigerant with higher GWP, if leaked to the atmosphere. This appliance contains a refrigerant fluid with a GWP equal to 550. This means that if 1 kg of this refrigerant fluid would be leaked to the atmosphere, the impact on global warming would be 550 times higher than 1 kg of CO₂ over a period of 100 years. Never try to interfere with the refrigerant circuit yourself or disassemble the product yourself and always ask a professional. The GWP of R32 is 675 in the IPCC 4th Assessment Report.

(*)2 Energy consumption based on standard test results. Actual energy consumption will depend on how the appliance is used and where it is located.

(*)3 SHi: Super High

(*)4 SEER, SCOP and other related description are based on COMMISSION DELEGATED REGULATION (EU) No.626/2011. The temperature conditions for calculating SCOP are based on "Average Season".

(*)5 Please see page 53-55 for heating (warmer season/colder season) specifications.

FT VGHZ ^{R32} SERIES

Single / Multi

Unlike conventional air conditioning systems, the FT Series don't lose heating capacity when it's cold outside. Original technologies ensure excellent heating performance under extremely low outdoor temperatures and an impressive guaranteed operating range. Furthermore, the smaller and stylish indoor unit does not give you the limitation of installation location.



MSZ-FT25/35/50VG(K)



Compact Design

The FT series features its compact design with 280mm height and 229mm depth, which is suitable for the installation above the door.



V Blocking Filter (Optional)



V Blocking Filter with antiviral effect inhibits 99% of adhered virus, and other harmful substances, such as bacteria, mold and allergen.

Two-layered filter with non-woven fabric and electrostatic filter can effectively capture and remove small particles from the air in your room.

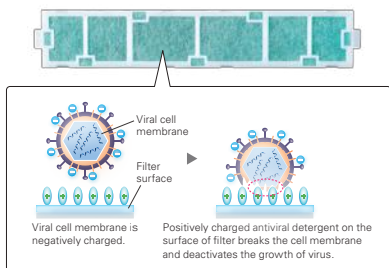

Remote Controller with Backlight

The remote controller screen is equipped with an LED backlight. The luminous screen allows you to check the setting easily even in the dark.



Circulator Mode

After reaching the target temperature, heating mode will automatically switch to Circulator mode, which makes the unit go into "fan-only" state and mixes warm air in the room.

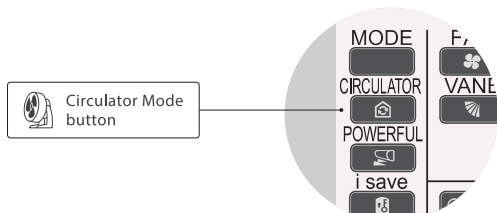

Built-in Wi-Fi

(MSZ-FT25/35/50VGK)

Mitsubishi Electric Wi-Fi Control gives you the freedom to tailor your heating and cooling needs through computers, tablets, or smartphones from anywhere.

Hyper Heating

Mitsubishi Electric's powerful compressor and highly cold-resistant parts enable the heat pump to provide 100% or more heating capacity even at -15°C , and also the heating operation is guaranteed down to -25°C .

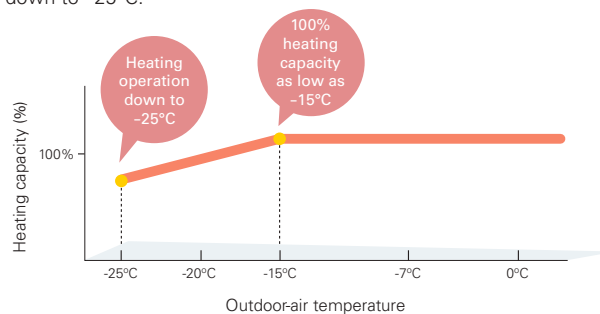

High Energy Efficiency – Energy Rank of A+ or higher for All Models



With indoor units that combine functionality, design and capacity and outdoor units equipped with a high-efficiency compressor, the MUZ-FT VGHZ simultaneously achieves high heating capacity and energy-saving performance.

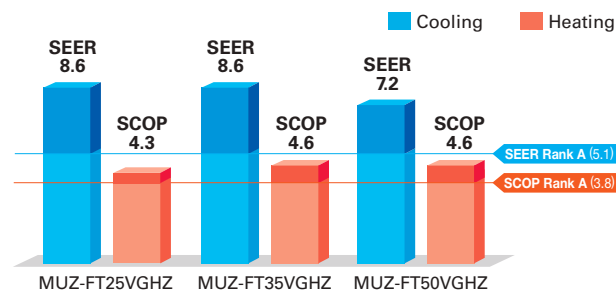

(MSZ-FT25/35/50VG(K)-SC Scandinavian Model)

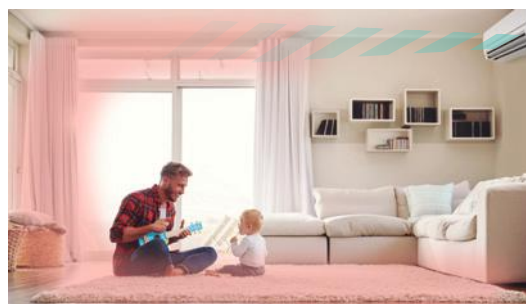

Image is for illustration purposes.

MSZ-FT VGHZ SERIES



Indoor Unit



MSZ-FT25/35/50VG(K)

Outdoor Unit



MUZ-FT25VGHZ

MUZ-FT35/50VGHZ

Remote Controller



Type		Inverter Heat Pump					
Indoor Unit		MSZ-FT25VG(K)	MSZ-FT35VG(K)	MSZ-FT50VG(K)			
Outdoor Unit		MUZ-FT25VGHZ	MUZ-FT35VGHZ	MUZ-FT50VGHZ			
Refrigerant		R32 ^{(*)1}					
Power Supply		Outdoor power supply					
Source		230 / Single / 50					
Outdoor (V/Phase/Hz)							
Cooling	Design Load		kW	2.5	3.5	5.0	
	Annual Electricity Consumption ^{(*)2}		kWh/a	101	142	243	
	SEER ^{(*)4}			8.6	8.6	7.2	
	Energy Efficiency Class			A+++	A+++	A++	
	Capacity	Rated	kW	2.5	3.5	5.0	
		Min - Max	kW	0.8 - 3.5	0.8 - 4.0	0.8 - 5.2	
	Total Input	Rated	kW	0.580	0.910	1.630	
Heating (Average Season) ^{(*)5}	Design Load		kW	3.2 (-10°C)	4.0 (-10°C)	5.0 (-10°C)	
	Declared Capacity	at reference design temperature	kW	3.2 (-10°C)	4.0 (-10°C)	5.0 (-10°C)	
		at bivalent temperature	kW	3.2 (-10°C)	4.0 (-10°C)	5.0 (-10°C)	
		at operation limit temperature	kW	3.0 (-25°C)	3.4 (-25°C)	3.6 (-25°C)	
	Back Up Heating Capacity		kW	0.0 (-10°C)	0.0 (-10°C)	0.0 (-10°C)	
	Annual Electricity Consumption ^{(*)2}		kWh/a	973	1216	1625	
	SCOP ^{(*)4}			4.6	4.6	4.3	
	Energy Efficiency Class			A++	A++	A+	
	Capacity	Rated	kW	3.2	4.0	5.0	
		Min - Max	kW	0.9 - 6.2	0.9 - 6.6	0.9 - 7.8	
Total Input	Rated	kW	0.760	1.020	1.300		
Operating Current (max)		A	10.0	11.6	13.9		
Indoor Unit	Input		Rated	kW	0.039	0.04	0.047
	Operating Current (max)		A		0.4		
	Dimensions		H x W x D	mm	280 - 838 - 229		
	Weight			kg	10		
	Air Volume (SLo-Lo-Mid-Hi-SHi ^{(*)3})	Cooling	m ³ /min	3.9 - 5.9 - 8.2 - 10.4 - 12.3	3.9 - 6.1 - 8.3 - 10.7 - 13.1	5.5 - 7.6 - 9.8 - 12.0 - 13.1	
		Heating	m ³ /min	3.9 - 6.3 - 9.0 - 12.0 - 13.2	3.9 - 6.9 - 10.2 - 13.5 - 14.7	5.5 - 8.4 - 11.4 - 14.4 - 15.5	
	Sound Level (SPL) (SLo-Lo-Mid-Hi-SHi ^{(*)3})	Cooling	dB(A)	19 - 27 - 36 - 41 - 46	19 - 27 - 36 - 42 - 47	28 - 34 - 40 - 45 - 48	
		Heating	dB(A)	19 - 31 - 39 - 46 - 49	19 - 33 - 42 - 49 - 52	28 - 36 - 45 - 51 - 54	
	Sound Level (PWL)		dB(A)		60		
	Outdoor Unit	Dimensions		H x W x D	mm	550 - 800 - 285	714 - 800 - 285
Weight			kg	34	40	40	
Air Volume		Cooling	m ³ /min	30.4	40.2	40.2	
		Heating	m ³ /min	30.4	40.2	40.2	
Sound Level (SPL)		Cooling	dB(A)	46	49	51	
		Heating	dB(A)	49	52	54	
Sound Level (PWL)		dB(A)	60	61	64		
Operating Current (max)		A	9.6	11.2	13.5		
Breaker Size		A	12	12	16		
Ext. Piping	Diameter		Liquid / Gas	mm	6.35 / 9.52	6.35 / 9.52	6.35 / 9.52
	Max. Length		Out-In	m	20	30	30
	Max. Height		Out-In	m	12	15	15
Guaranteed Operating Range (Outdoor)		Cooling	°C	-10 ~ +46	-10 ~ +46	-10 ~ +46	
		Heating	°C	-25 ~ +24	-25 ~ +24	-25 ~ +24	

(*)1 Refrigerant leakage contributes to climate change. Refrigerant with lower global warming potential (GWP) would contribute less to global warming than a refrigerant with higher GWP if leaked to the atmosphere. This appliance contains a refrigerant fluid with a GWP equal to 1975. This means that if 1kg of this refrigerant fluid would be leaked to the atmosphere, the impact on global warming would be 1975 times higher than 1kg of CO₂ over a period of 100 years. Never try to interfere with the refrigerant circuit yourself or disassemble the product yourself and always ask a professional. The GWP of R410A is 2088 in the IPCC 4th Assessment Report.

(*)2 Energy consumption based on standard test results. Actual energy consumption will depend on how the appliance is used and where it is located.

(*)3 SHi: Super High

(*)4 SEER, SCOP and other related description are based on COMMISSION DELEGATED REGULATION (EU) No.626/2011. The temperature conditions for calculating SCOP are based on "Average Season".

(*)5 Please see page 53-55 for heating (warmer season) specifications.

MFZ-KW SERIES



Indoor Unit



MFZ-KW25/35/50/60VG



Outdoor Unit



MUFZ-KW25/35VGHZ



MUFZ-KW50/60VGHZ

Remote Controller

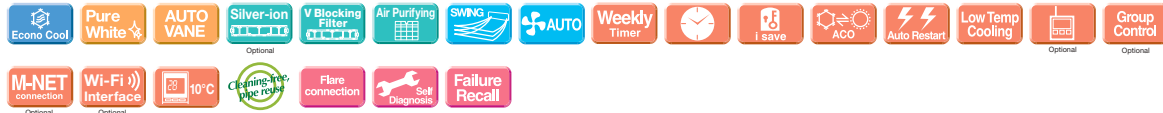

Type		Inverter Heat Pump					
Indoor Unit		MFZ-KW25VG	MFZ-KW35VG	MFZ-KW50VG	MFZ-KW60VG		
Outdoor Unit		MUFZ-KW25VGHZ	MUFZ-KW35VGHZ	MUFZ-KW50VGHZ	MUFZ-KW60VGHZ		
Refrigerant		R32 ^{(*)1}					
Power Supply		Outdoor power supply					
Source		230 / Single / 50					
Outdoor (V/Phase/Hz)							
Cooling	Design Load	kW	2.5	3.5	5.0	6.1	
	Annual Electricity Consumption ^{(*)2}	kWh/a	103	151	255	316	
	SEER ^{(*)4}		8.5	8.1	6.8	6.7	
	Energy Efficiency Class			A+++	A++	A++	A++
	Capacity	Rated	kW	2.5	3.5	5.0	6.1
		Min - Max	kW	0.7 - 3.6	0.7 - 4.3	1.0 - 5.8	1.0 - 6.5
	Total Input	Rated	kW	0.57	0.90	1.36	1.73
Heating (Average Season)	Design Load	kW	3.5	3.6	4.5	4.8	
	Declared Capacity	at reference design temperature	kW	3.5 (-10°C)	3.6 (-10°C)	4.5 (-10°C)	4.8 (-10°C)
		at bivalent temperature	kW	3.5 (-10°C)	3.6 (-10°C)	4.5 (-10°C)	4.8 (-10°C)
		at operation limit temperature	kW	2.6 (-25°C)	2.6 (-25°C)	4.0 (-25°C)	4.0 (-25°C)
	Back Up Heating Capacity		kW	0.0 (-10°C)	0.0 (-10°C)	0.0 (-10°C)	0.0 (-10°C)
	Annual Electricity Consumption ^{(*)2}	kWh/a	1188	1211	1500	1624	
	SCOP ^{(*)4}		4.1	4.1	4.2	4.1	
	Energy Efficiency Class			A+	A+	A+	A+
	Capacity	Rated	kW	3.4	4.3	6.0	6.5
		Min - Max	kW	0.2 - 5.1	0.2 - 6.0	1.2 - 8.4	1.2 - 9.0
Total Input	Rated	kW	0.83	1.21	1.60	1.88	
Operating Current (max)		A	9.9	10.3	15.3	15.4	
Indoor Unit	Input (Cooling/Heating)	Rated	kW	0.019/0.025	0.019/0.025	0.026/0.052	0.063/0.059
	Operating Current (max)		A	0.22	0.22	0.47	0.55
	Dimensions	H x W x D	mm	600 - 750 - 215			
	Weight		kg	15	15	15	15
	Air Volume (SLo-Lo-Mid-Hi-SHi ^{(*)3})	Cooling	m ³ /min	3.9 - 4.9 - 5.9 - 7.1 - 8.2	3.9 - 4.9 - 5.9 - 7.1 - 8.2	5.6 - 6.7 - 8.0 - 9.3 - 10.6	5.6 - 8.0 - 9.6 - 12.3 - 15.0
		Heating	m ³ /min	3.5 - 5.1 - 6.2 - 7.7 - 9.7	3.5 - 5.1 - 6.2 - 7.7 - 9.7	6.0 - 7.4 - 9.4 - 11.6 - 14.0	6.0 - 7.7 - 9.7 - 12.5 - 14.6
	Sound Level (SPL) (SLo-Lo-Mid-Hi-SHi ^{(*)3})	Cooling	dB(A)	20 - 25 - 30 - 35 - 39	20 - 25 - 30 - 35 - 39	27 - 31 - 35 - 39 - 44	27 - 35 - 39 - 46 - 53
		Heating	dB(A)	18 - 25 - 30 - 35 - 41	18 - 25 - 30 - 35 - 41	29 - 35 - 40 - 45 - 50	29 - 35 - 41 - 47 - 51
	Sound Level (PWL)		dB(A)	49	50	56	65
	Outdoor Unit	Dimensions	H x W x D	mm	550 - 800 - 285		880 - 840 - 330
Weight			kg	35	35	54	54
Air Volume		Cooling	m ³ /min	32.7	32.7	43.8	48.8
		Heating	m ³ /min	27.3	27.3	46.3	51.3
Sound Level (SPL)		Cooling	dB(A)	47	47	50	52
		Heating	dB(A)	46	47	54	56
Sound Level (PWL)		Cooling	dB(A)	61	61	65	66
Operating Current (max)			A	9.6	10.0	14.8	14.8
Breaker Size			A	10	12	16	16
Ext. Piping		Diameter	Liquid / Gas	mm	6.35 / 9.52	6.35 / 9.52	6.35 / 12.7
	Max. Length	Out-In	m	20	20	30	30
	Max. Height	Out-In	m	12	12	15	15
Guaranteed Operating Range (Outdoor)	Cooling	°C	-10 ~ +46	-10 ~ +46	-10 ~ +46	-10 ~ +46	
	Heating	°C	-25 ~ +24	-25 ~ +24	-25 ~ +24	-25 ~ +24	

(*)1 Refrigerant leakage contributes to climate change. Refrigerant with lower global warming potential (GWP) would contribute less to global warming than a refrigerant with higher GWP if leaked to the atmosphere. This appliance contains a refrigerant fluid with a GWP equal to 1975. This means that if 1kg of this refrigerant fluid would be leaked to the atmosphere, the impact on global warming would be 1975 times higher than 1kg of CO₂ over a period of 100 years. Never try to interfere with the refrigerant circuit yourself or disassemble the product yourself and always ask a professional. The GWP of R410A is 2088 in the IPCC 4th Assessment Report.

(*)2 Energy consumption based on standard test results. Actual energy consumption will depend on how the appliance is used and where it is located.

(*)3 SHi: Super High

(*)4 SEER, SCOP and other related description are based on COMMISSION DELEGATED REGULATION (EU) No.626/2011. The temperature conditions for calculating SCOP are based on "Average Season".

ZUBADAN SERIES

The ZUBADAN Series incorporates an original Flash Injection technology that improves the already high heating capacity of the system. This new member of the series line-up ensures comfortable heat pump-driven heating performance in cold regions.



* Units in photo are Japanese models.
European model specifications are different.

Improved Heating Performance

Mitsubishi Electric's unique "Flash Injection" circuit achieves remarkably high heating performance. This technology has resulted in an excellent heating capacity rating in outdoor temperatures as low as -15°C , and the guaranteed heating operation range of the heating mode has been extended to -25°C . Accordingly, the heat-pump units of the ZUBADAN Series are perfect for warming homes in the coldest of regions.

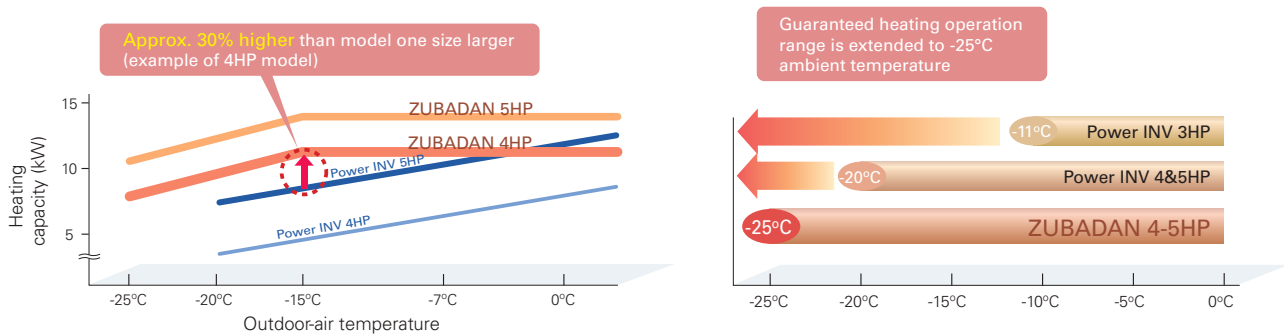

Enhanced Comfort

The Flash Injection circuit improves start-up and recover from the defrosting operation. A newly introduced defrost operation control also improves defrost frequency. These features enable the temperature to reach the set temperature more quickly, and contribute to maintaining it at the desired setting.

Quick Start-up

■ Operation at $+2^{\circ}\text{C}$ outdoor temperature

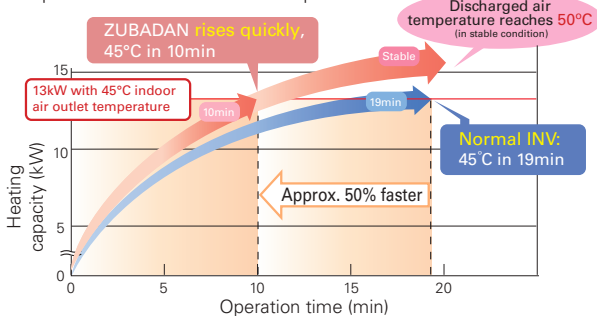

■ Operation at -20°C outdoor temperature

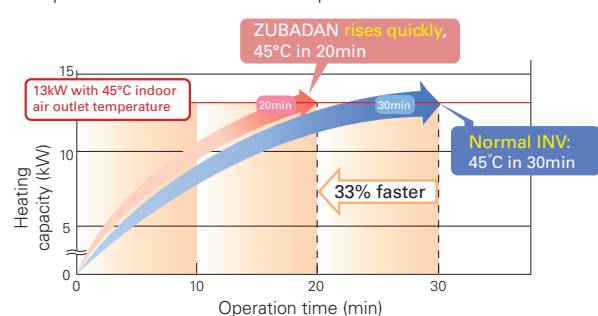

ZUBADAN Defrost Control and Faster Recovery from Defrost Operation

Field Test Results: Office building in Asahikawa, Hokkaido, Japan

■ Operation data for 25 Jan. 2005

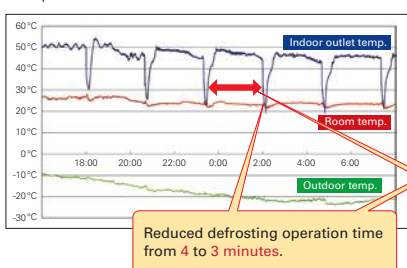

■ Operation data for 2 Dec. 2004

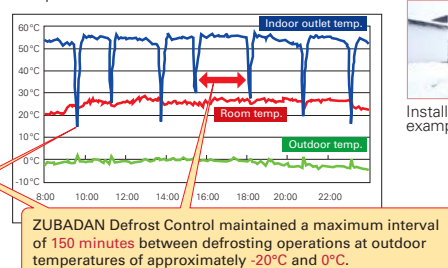

Installation example



ErP Lot 10 Compliant with High Energy-efficiency Achieving SEER/SCOP Rank A and A+



Powerful heating yet annually high energy efficiency in both cooling and heating, achieving rank A and A+.

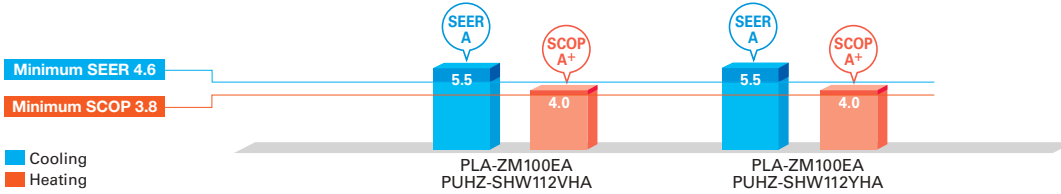

Mitsubishi Electric's Flash Injection Technology The Key to High Heating Performance at Low Outdoor Temperatures

Flash Injection Circuit

ZUBADAN

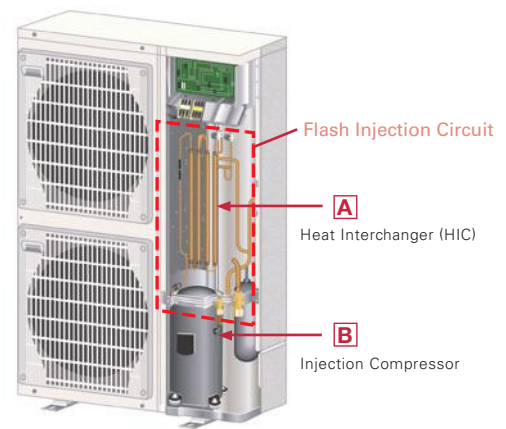
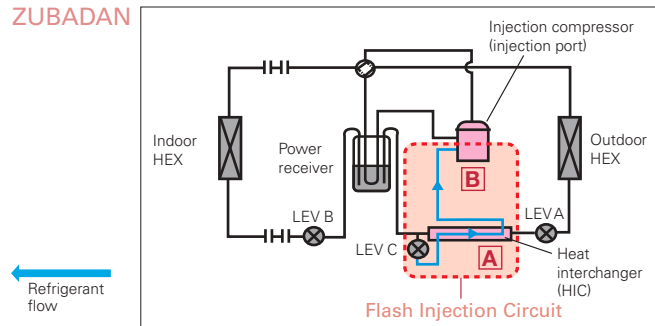

The ZUBADAN Series is equipped with Mitsubishi Electric's original Flash Injection Circuit, which is comprised of a bypass circuit and heat interchanger (HIC). The HIC transforms rerouted liquid refrigerant into a gas-liquid state to lower compression load. This process ensures excellent heating performance even when the outdoor temperature drops very low.

In traditional units, when the outdoor temperature is low, the volume of refrigerant circulating in the compressor decreases due to the drop in refrigerant pressure and the protection from overheating caused by high compression, thereby reducing heating capacity. The Flash Injection Circuit injects refrigerant to maintain the refrigerant circulation volume and compressor operation load, thereby maintaining heating capacity.

Mollier Chart Image Representing Flash Injection Circuit Operation

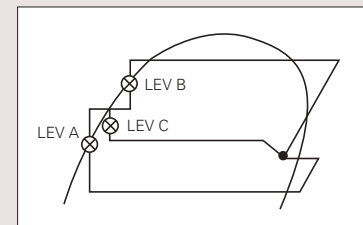

A Heat Interchanger (HIC)

HIC cross-sectional view

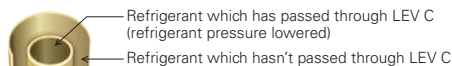

Purpose: Transform liquid refrigerant into liquid-gas state
Effect: Injection circuit increases energy efficiency

The compressor is subjected to a heavy load when compressing liquid refrigerant, and the result is lower operation efficiency. The addition of HIC supports refrigerant heat exchange at two different pressure levels. The heat-exchange process transforms the injected liquid refrigerant into a gas liquid state, thereby decreasing the load on the compressor during the compression process.

B Injection Compressor

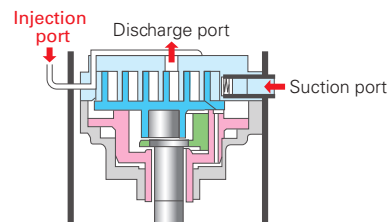

Purpose: To increase the volume of refrigerant being circulated
Effect: Improves heating capacity at low outdoor temperatures, and enables higher indoor-air outlet temperature adjustment and higher defrost operation speed

Refrigerant passes from the HIC into the compressor through the injection port. Having two refrigerant inlets makes it possible to raise the volume of refrigerant being circulated when the outdoor temperature is low and at the start of heating operation.

PLZ-SHW SERIES



Indoor Unit

R32
R410A



PLA-ZM100/125EA2

Panel

Panel	With Signal Receiver	With 3D i-see Sensor	With Wireless Remote Controller	With Auto Elevation
PLP-6EA				
PLP-6EAL	✓			
PLP-6EAE		✓		
PLP-6EALE	✓	✓		
PLP-6EAJ	✓			✓
PLP-6EAJE	✓	✓		✓
PLP-6EALM2	✓		✓	
PLP-6EALME2	✓	✓	✓	

Outdoor Unit

R410A



PUHZ-SHW112VHA(-BS)
PUHZ-SHW112/140YHA(-BS)

Remote Controller



Enclosed in
PLP-6EALM2/
PLP-6EALME2



*optional



*optional



*optional



Type	Inverter Heat Pump						
Indoor Unit	PLA-ZM100EA2						
Outdoor Unit	PUHZ-SHW112VHA	PUHZ-SHW112YHA	PUHZ-SHW140YHA				
Refrigerant	R410A*1						
Power Supply	Outdoor power supply VHA: 230 / Single / 50, YHA: 400 / Three / 50						
Cooling	Capacity	Rated	10.0	10.0	12.5		
		Min - Max	kW	4.9 - 11.4	4.9 - 11.4	5.5 - 14.0	
	Total Input	Rated	kW	2.857	2.857	5.000	
	EER			3.50	3.50	2.50	
		EEL Rank		-	-	-	
	Design Load		kW	10.0	10.0	-	
	Annual Electricity Consumption*2		kWh/a	633	633	-	
	SEER*4			5.5	5.5	-	
		Energy Efficiency Class		A	A	-	
	Heating (Average Season)	Capacity	Rated	11.2	11.2	14.0	
		Min - Max	kW	4.5 - 14.0	4.5 - 14.0	5.0 - 16.0	
Total Input		Rated	kW	2.667	2.667	4.000	
COP				4.20	4.20	3.50	
		EEL Rank		-	-	-	
Design Load			kW	12.7	12.7	-	
Declared Capacity			at reference design temperature	kW	11.2 (-10°C)	11.2 (-10°C)	-
			at bivalent temperature	kW	11.2 (-7°C)	11.2 (-7°C)	-
			at operation limit temperature	kW	9.3 (-25°C)	9.3 (-25°C)	-
		Back Up Heating Capacity		kW	1.5	1.5	-
Annual Electricity Consumption*2		kWh/a	4420	4420	-		
SCOP*4			4.0	4.0	-		
	Energy Efficiency Class		A+	A+	-		
Operating Current (max)		A	35.5	13.5	13.5		
Indoor Unit	Input [Cooling/Heating]	Rated	kW	0.07 / 0.07	0.07 / 0.07	0.08 / 0.08	
	Operating Current (max)		A	0.47	0.47	0.52	
	Dimensions <Panel>	H x W x D	mm		298-840-840 <40-950-950>		
	Weight <Panel>		kg	26 <5>	26 <5>	26 <5>	
	Air Volume [Lo-Mi2-Mi1-Hi]		m³/min	19 - 22 - 25 - 28	19 - 22 - 25 - 28	21 - 24 - 26 - 29	
	Sound Level (SPL) [Lo-Mi2-Mi1-Hi]		dB(A)	31 - 34 - 37 - 40	31 - 34 - 37 - 40	33 - 36 - 39 - 41	
	Sound Level (PWL)		dB(A)	61	61	62	
Outdoor Unit	Dimensions	H x W x D	mm		1350 - 950 - 330 (+30)		
	Weight		kg	120	134	134	
	Air Volume	Cooling	m³/min	100	100	100	
		Heating	m³/min	100	100	100	
	Sound Level (SPL)	Cooling	dB(A)	51	51	51	
		Heating	dB(A)	52	52	52	
	Sound Level (PWL)	Cooling	dB(A)	69	69	69	
		Heating	dB(A)	69	69	69	
	Operating Current (max)		A	35	13	13	
	Breaker Size		A	40	16	16	
Ext. Piping	Diameter	Liquid / Gas	mm	9.52 / 15.88	9.52 / 15.88	9.52 / 15.88	
	Max. Length	Out-In	m	75	75	75	
	Max. Height	Out-In	m	30	30	30	
Guaranteed Operating Range [Outdoor]	Cooling*3	°C	-15 ~ +46	-15 ~ +46	-15 ~ +46		
	Heating	°C	-25 ~ +21	-25 ~ +21	-25 ~ +21		

*1 Refrigerant leakage contributes to climate change. Refrigerant with lower global warming potential (GWP) would contribute less to global warming than a refrigerant with higher GWP, if leaked to the atmosphere. This appliance contains a refrigerant fluid with a GWP equal to 1975. This means that if 1 kg of this refrigerant fluid would be leaked to the atmosphere, the impact on global warming would be 1975 times higher than 1 kg of CO₂ over a period of 100 years. Never try to interfere with the refrigerant circuit yourself or disassemble the product yourself and always ask a professional.

*2 Energy consumption based on standard test results. Actual energy consumption will depend on how the appliance is used and where it is located.

*3 Optional air protection guide is required where ambient temperature is lower than -5°C.

*4 SEER and SCOP are based on 2009/125/EC:Energy-related Products Directive and Regulation(EU) No206/2012.

PLZ-SHW SERIES



Indoor Unit

R410A



PLA-M100/125EA2

Panel

Panel	With Signal Receiver	With 3D i-see Sensor	With Wireless Remote Controller	With Auto Elevation
PLP-6EA				
PLP-6EAL	✓			
PLP-6EAE		✓		
PLP-6EALE	✓	✓		
PLP-6EAJ	✓			✓
PLP-6EAJE	✓	✓		✓
PLP-6EALM2	✓		✓	
PLP-6EALME2	✓	✓	✓	

Outdoor Unit

R410A

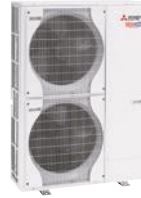

PUHZ-SHW112VHA(-BS)
PUHZ-SHW112/140YHA(-BS)

Remote Controller



Enclosed in
PLP-6EALM2/
PLP-6EALME2



*optional



*optional



*optional



Type	Inverter Heat Pump					
Indoor Unit	PLA-M100EA2					
Outdoor Unit	PUHZ-SHW112VHA	PUHZ-SHW112YHA	PUHZ-SHW140YHA			
Refrigerant	R410A*1					
Power Supply	Outdoor power supply VHA: 230 / Single / 50, YHA: 400 / Three / 50					
Cooling	Capacity	Rated	10.0	10.0	12.5	
		Min - Max	kW	4.9 - 11.4	4.9 - 11.4	5.5 - 14.0
	Total Input	Rated	kW	2.940	2.940	5.000
	EER			3.40	3.40	2.50
		EEL Rank		-	-	-
	Design Load		kW	10.0	10.0	-
	Annual Electricity Consumption*2		kWh/a	661	661	-
Heating (Average Season)	Capacity	Rated	11.2	11.2	14.0	
		Min - Max	kW	4.5 - 14.0	4.5 - 14.0	5.0 - 16.0
	Total Input	Rated	kW	2.793	2.793	4.000
	COP			4.01	4.01	3.50
		EEL Rank		-	-	-
	Design Load		kW	12.7	12.7	-
	Declared Capacity	at reference design temperature	kW	11.2 (-10°C)	11.2 (-10°C)	-
	at bivalent temperature	kW	11.2 (-7°C)	11.2 (-7°C)	-	
	at operation limit temperature	kW	9.3 (-25°C)	9.3 (-25°C)	-	
Back Up Heating Capacity		kW	1.5	1.5	-	
Annual Electricity Consumption*2		kWh/a	4445	4445	-	
SCOP*4			4.0	4.0	-	
	Energy Efficiency Class		A+	A+	-	
Operating Current (max)		A	35.5	13.5	13.7	
Indoor Unit	Input [Cooling/Heating]	Rated	kW	0.07 / 0.07	0.07 / 0.07	0.08 / 0.08
	Operating Current (max)		A	0.47	0.47	0.52
	Dimensions <Panel>	H x W x D	mm		298-840-840 <40-950-950>	
	Weight <Panel>		kg	26 <5>	26 <5>	26 <5>
	Air Volume [Lo-Mi2-Mi1-Hi]		m³/min	19 - 22 - 25 - 28	19 - 22 - 25 - 28	21 - 24 - 26 - 29
	Sound Level (SPL) [Lo-Mi2-Mi1-Hi]		dB(A)	31 - 34 - 37 - 40	31 - 34 - 37 - 40	33 - 36 - 39 - 41
Sound Level (PWL)		dB(A)	61	61	62	
Outdoor Unit	Dimensions	H x W x D	mm	1350 - 950 - 330 (+30)		
	Weight		kg	120	134	134
	Air Volume	Cooling	m³/min	100	100	100
		Heating	m³/min	100	100	100
	Sound Level (SPL)	Cooling	dB(A)	51	51	51
		Heating	dB(A)	52	52	52
	Sound Level (PWL)	Cooling	dB(A)	69	69	69
Operating Current (max)		A	35	13	13	
Breaker Size		A	40	16	16	
Ext. Piping	Diameter	Liquid / Gas	mm	9.52 / 15.88		
	Max. Length	Out-In	m	75		
	Max. Height	Out-In	m	30		
Guaranteed Operating Range [Outdoor]	Cooling*3	°C	-15 ~ +46			
	Heating	°C	-25 ~ +21			

*1 Refrigerant leakage contributes to climate change. Refrigerant with lower global warming potential (GWP) would contribute less to global warming than a refrigerant with higher GWP, if leaked to the atmosphere. This appliance contains a refrigerant fluid with a GWP equal to 1975. This means that if 1kg of this refrigerant fluid would be leaked to the atmosphere, the impact on global warming would be 1975 times higher than 1kg of CO₂ over a period of 100 years. Never try to interfere with the refrigerant circuit yourself or disassemble the product yourself and always ask a professional.

*2 Energy consumption based on standard test results. Actual energy consumption will depend on how the appliance is used and where it is located.

*3 Optional air protection guide is required where ambient temperature is lower than -5°C.

*4 SEER and SCOP are based on 2009/125/EC:Energy-related Products Directive and Regulation(EU) No206/2012.

PEDZ-SHW JA SERIES



Indoor Unit

R32
R410A

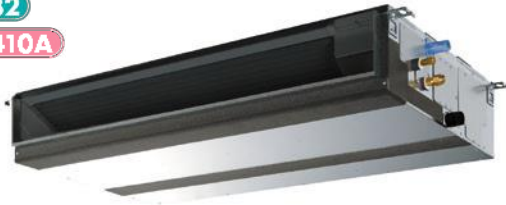

PEAD-M100/125JA(L)2

Outdoor Unit

R410A

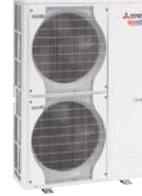

PUHAZ-SHW112VHA(-BS)
PUHAZ-SHW112/140YHA(-BS)

Remote Controller

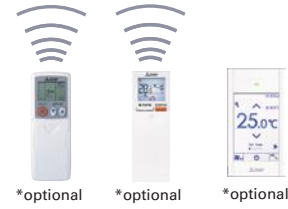

*optional *optional *optional



*optional *optional

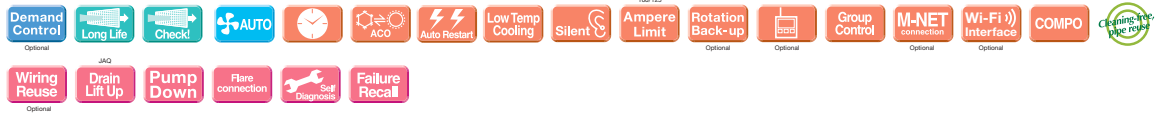

Type		Inverter Heat Pump					
Indoor Unit		PEAD-M100JA(L)2		PEAD-M125JA(L)2			
Outdoor Unit		PUHAZ-SHW112VHA		PUHAZ-SHW112YHA			
Refrigerant		R410A*1					
Power Supply		Outdoor power supply					
Source		VHA: 230 / Single / 50, YHA: 400 / Three / 50					
Outdoor (V/Phase/Hz)							
Cooling	Capacity	Rated	kW	10.0	10.0	12.1	
		Min - Max	kW	4.9 - 11.4	4.9 - 11.4	5.5 - 14.0	
	Total Input	Rated	kW	2.904	2.904	4.172	
	EER			3.44	3.44	2.90	
		EEL Rank		-	-	-	
	Design Load		kW	10.0	10.0	12.1	
	Annual Electricity Consumption*2		kWh/a	686	686	-	
SEER*4			5.1	5.1	-		
	Energy Efficiency Class		A	A	-		
Heating (Average Season)	Capacity	Rated	kW	11.2	11.2	14.0	
		Min - Max	kW	4.5 - 14.0	4.5 - 14.0	5.0 - 16.0	
	Total Input	Rated	kW	3.103	3.103	3.879	
	COP			3.61	3.61	3.61	
		EEL Rank		-	-	-	
	Design Load		kW	12.7	12.7	-	
	Declared Capacity	at reference design temperature	kW	11.2 (-10°C)	11.2 (-10°C)	-	
		at bivalent temperature	kW	11.2 (-7°C)	11.2 (-7°C)	-	
		at operation limit temperature	kW	9.4 (-25°C)	9.4 (-25°C)	-	
	Back Up Heating Capacity		kW	1.5	1.5	-	
Annual Electricity Consumption*2		kWh/a	4601	4601	-		
SCOP*4			3.8	3.8	-		
	Energy Efficiency Class		A	A	-		
Operating Current (max)			A	37.7	15.7	15.8	
Indoor Unit	Input [Cooling / Heating]	Rated	kW	0.14	0.14	0.20	
	Operating Current (max)		A	2.25	2.25	2.34	
	Dimensions	H x W x D	mm	250 - 1400 - 732	250 - 1400 - 732	250 - 1400 - 732	
	Weight		kg	36	36	37	
	Air Volume [Lo-Mid-Hi]		m³/min	23.0-28.0-32.0	23.0 - 28.0 - 32.0	28.0 - 34.0 - 37.0	
	External Static Pressure*5		Pa	40 - <50> - <70> - <100> - <150>	40 - <50> - <70> - <100> - <150>	<40> - 50 - <70> - <100> - <150>	
	Sound Level (SPL) [Lo-Mid-Hi]		dB(A)	31 - 36 - 39	31 - 36 - 39	35 - 39 - 41	
	Sound Level (PWL)		dB(A)	62	62	66	
	Outdoor Unit	Dimensions	H x W x D	mm	1350 - 950 - 330 (+30)	1350 - 950 - 330 (+30)	1350 - 950 - 330 (+30)
		Weight		kg	120	134	134
Air Volume		Cooling	m³/min	100	100	100	
		Heating	m³/min	100	100	100	
Sound Level (SPL)		Cooling	dB(A)	51	51	51	
		Heating	dB(A)	52	52	52	
Sound Level (PWL)		Cooling	dB(A)	69	69	69	
Operating Current (max)		A	35	13	13		
Breaker Size		A	40	16	16		
Ext. Piping	Diameter	Liquid / Gas	mm	9.52 / 15.88	9.52 / 15.88	9.52 / 15.88	
	Max. Length	Out-In	m	75	75	75	
	Max. Height	Out-In	m	30	30	30	
Guaranteed Operating Range [Outdoor]	Cooling*3	°C	-15 ~ +46	-15 ~ +46	-15 ~ +46		
	Heating	°C	-25 ~ +21	-25 ~ +21	-25 ~ +21		

*1 Refrigerant leakage contributes to climate change. Refrigerant with lower global warming potential (GWP) would contribute less to global warming than a refrigerant with higher GWP, if leaked to the atmosphere. This appliance contains a refrigerant fluid with a GWP equal to 1975. This means that if 1kg of this refrigerant fluid would be leaked to the atmosphere, the impact on global warming would be 1975 times higher than 1kg of CO₂, over a period of 100 years. Never try to interfere with the refrigerant circuit yourself or disassemble the product yourself and always ask a professional.

*2 Energy consumption based on standard test results. Actual energy consumption will depend on how the appliance is used and where it is located.

*3 Optional air protection guide is required where ambient temperature is lower than -5°C.

*4 SEER and SCOP are based on 2009/125/EC:Energy-related Products Directive and Regulation(EU) No206/2012.

*5 The factory setting of ESP is shown without < .>

PKZ-SHW SERIES

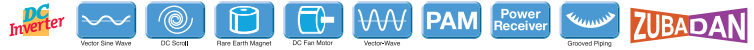

Indoor Unit

R32
R410A



PKA-M100KA(L)2

Outdoor Unit

R410A



PUHZ-SHW112VHA(-BS)
PUHZ-SHW112YHA(-BS)

Remote Controller



*KAL only



*optional



*optional



*optional

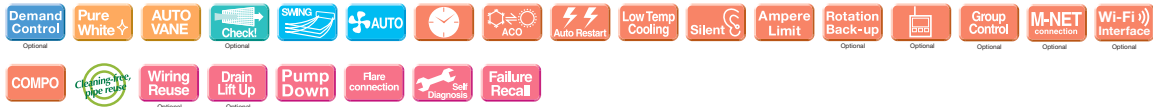

Type		Inverter Heat Pump				
Indoor Unit		PKA-M100KA(L)2				
Outdoor Unit		PUHZ-SHW112VHA		PUHZ-SHW112YHA		
Refrigerant		R410A*1				
Power Supply		Outdoor power supply VHA: 230 / Single / 50, YHA: 400 / Three / 50				
Cooling	Capacity	Rated	kW	10.0		
		Min - Max	kW	4.9 - 11.4		
	Total Input	Rated	kW	2.924 (2.904)		
	Design Load		kW	3.42		
	Annual Electricity Consumption*2		kWh/a	673		
	SEER*4			5.2		
		Energy Efficiency Class		A		
Heating (Average Season)	Capacity	Rated	kW	11.2		
		Min - Max	kW	4.5 - 14.0		
	Total Input	Rated	kW	3.103		
	Design Load		kW	12.7		
	Declared Capacity		at reference design temperature	kW	11.2 (-10°C)	
			at bivalent temperature	kW	11.2 (-7°C)	
			at operation limit temperature	kW	9.4 (-25°C)	
	Back Up Heating Capacity		kW	1.5		
	Annual Electricity Consumption*2		kWh/a	4664		
	SCOP*3			3.8		
		Energy Efficiency Class		A		
Operating Current (max)			A	35.6		
Indoor Unit	Input	Rated	kW	0.08 / 0.07		
	Operating Current (max)		A	0.57		
	Dimensions <Panel>	H x W x D	mm	365 - 1170 - 295		
	Weight <Panel>		kg	21		
	Air Volume [Lo-Mid-Hi]		m³/min	20 - 23 - 26		
	Sound Level (SPL) [Lo-Mid-Hi]		dB(A)	41 - 45 - 49		
	Sound Level (PWL)		dB(A)	65		
Outdoor Unit	Dimensions	H x W x D	mm	1350 - 950 - 330 (+30)		
	Weight		kg	120		
	Air Volume	Cooling	m³/min	100		
		Heating	m³/min	100		
	Sound Level (SPL)	Cooling	dB(A)	51		
		Heating	dB(A)	52		
	Sound Level (PWL)	Cooling	dB(A)	69		
	Operating Current (max)		A	35		
	Breaker Size		A	40		
	Ext. Piping	Diameter	Liquid / Gas	mm	9.52 / 15.88	
Max. Length		Out-In	m	75		
Max. Height		Out-In	m	30		
Guaranteed Operating Range (Outdoor)	Cooling*3		°C	-15 ~ +46		
	Heating		°C	-25 ~ +21		

*1 Refrigerant leakage contributes to climate change. Refrigerant with lower global warming potential (GWP) would contribute less to global warming than a refrigerant with higher GWP, if leaked to the atmosphere. This appliance contains a refrigerant fluid with a GWP equal to 1975. This means that if 1kg of this refrigerant fluid would be leaked to the atmosphere, the impact on global warming would be 1975 times higher than 1kg of CO₂ over a period of 100 years. Never try to interfere with the refrigerant circuit yourself or disassemble the product yourself and always ask a professional.
 *2 Energy consumption based on standard test results. Actual energy consumption will depend on how the appliance is used and where it is located.
 *3 Optional air protection guide is required where ambient temperature is lower than -5°C.
 *4 SEER and SCOP are based on 2009/125/EC:Energy-related Products Directive and Regulation(EU) No206/2012.

MXZ-VAHZ SERIES

New hyper-heating MXZ allows you to create an oasis of comfort throughout your home and office in the rooms you use most, any time of the year.



Standard rated heating capacity is maintained even when the outside-air temperature drops to -15°C .

Maintains high capacity output even when outside-air temperature is low.

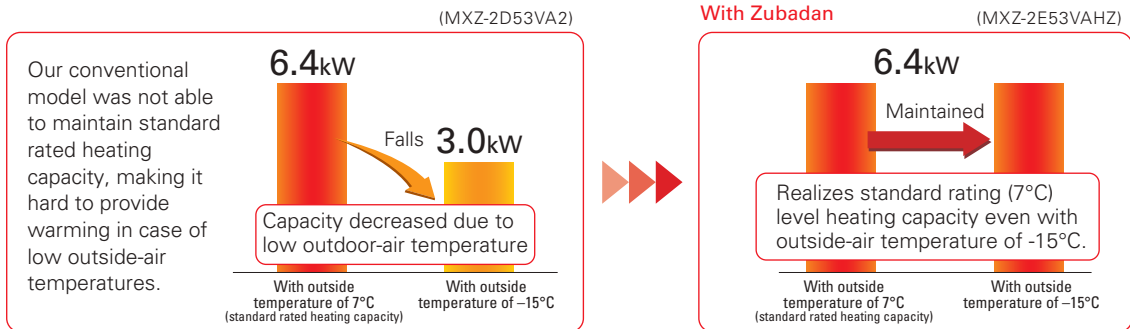

Can operate at outside-air temperature of -25°C

1. Incorporated key parts resistant to cold of up to -25°C after rigorous selection.
2. Printed circuit board-core of the air conditioner—is coated on both sides to protect it in harsh environments.

Freeze-prevention heater standard equipment

Prevents capacity loss and operation from stopping due to drain water freezing.

Drain water **freezes** after operation in the harsh cold



With Hyper heating Does not freeze!



Continuous heating for long periods

Wasteful defrosting operation suppressed to enable more comfortable long-term continuous heating.

Extremely cold outside

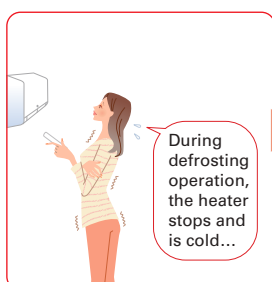

With Hyper heating

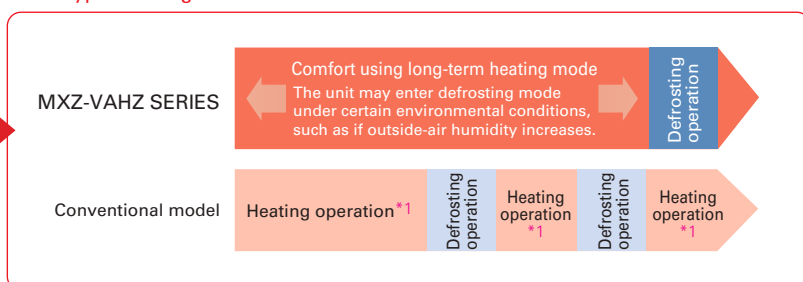

*1: Conventional model performs continuous heating approximately 30min up to a maximum of 90min.

One outdoor unit supports multiple indoor units.

With MXZ-VAHZ, one outdoor unit can cool and heat up to six rooms. They can be installed neatly in sites with limited space such as condominium balconies.

*Please note that cooling and heating modes cannot be run simultaneously in different rooms.

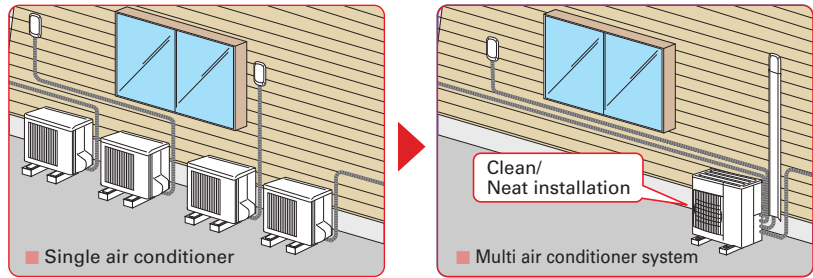

EXAMPLE SYSTEM

MXZ-4F83VFHZ system

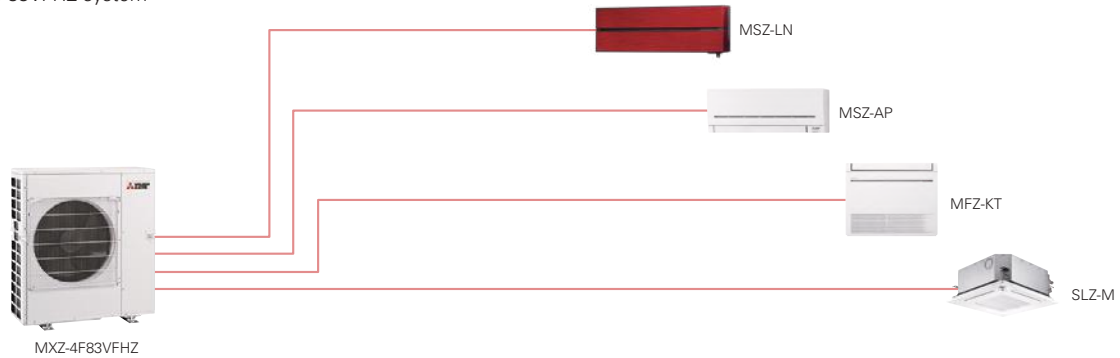

Freedom of combinations in cold region greatly enhanced

The variety of indoor unit connection options in cold regions, restricted until now, has been greatly increased. Increased design freedom.

OUTDOOR UNITS

2-room use



4-room use



INDOOR UNITS

Wall-mounted



Floor-standing



Cassette



Ceiling-suspended



Ceiling-concealed



*1: P Series cannot be connect with MXZ-4E83VAHZ when ampere limit adjustment function is operated.

MXZ-VAHZ SERIES



Outdoor Unit

R32



MXZ-2F53VFHZ2

R32



MXZ-4F83VFHZ2

R410A



MXZ-2E53VAHZ

R410A



MXZ-4E83VAHZ

Type			Inverter Heat Pump					
Indoor Unit			Please refer to ^{*4, *5}					
Outdoor Unit			MXZ-2F53VFHZ2	MXZ-4F83VFHZ2	MXZ-2E53VAHZ	MXZ-4E83VAHZ		
Refrigerant			R32 ^{*6}		R410A ^{*1}			
Power Supply	Source		Outdoor power supply					
	Outdoor (V/Phase/Hz)		220 - 230 - 240V / Single / 50					
Cooling	Capacity	Rated	kW	5.3	8.3	5.3	8.3	
		Min - Max	kW	1.1 - 6.0	3.5 - 9.2	1.1 - 6.0	3.5 - 9.2	
	Total Input	Rated	kW	1.29	1.90	1.29	2.25	
	Design Load		kW	5.3	8.3	5.3	8.3	
	Annual Electricity Consumption ^{*2}		kWh/a	274	398	282	447	
	SEER ^{*4, *7}			6.8	7.3	6.5	6.5	
		Energy Efficiency Class ^{*4}		A++	A++	A++	A++	
Heating (Average Season)	Capacity	Rated (7°C)	kW	6.4	9.0	6.4	9.0	
		Rated (-7°C)	kW	6.4	9.0	6.4	9.0	
		Rated (-15°C)	kW	6.4	9.0	6.4	9.0	
		Min - Max	kW	1.0 - 7.0	3.5 - 11.6	1.0 - 7.0	3.5 - 11.6	
		Total Input	Rated	kW	1.36	1.70	1.36	1.90
	Design Load		kW	6.4	10.1	6.4	10.1	
	Declared Capacity	at reference design temperature	kW	6.9	10.6	6.4	9.0	
		at bivalent temperature	kW	7.4	11.5	6.4	9.0	
		at operation limit temperature	kW	4.1	5.7	2.4	2.5	
	Back Up Heating Capacity		kW	0.0	0.0	0.0	1.1	
	Annual Electricity Consumption ^{*2}		kWh/a	2172	3286	2165	3446	
SCOP ^{*7}			4.1	4.3	4.1	4.1		
	Energy Efficiency Class ^{*4}		A+	A+	A+	A+		
Max. Operating Current (Indoor+Outdoor)			A	15.6	28.0	15.6	28.0	
Outdoor Unit	Dimensions		H x W x D	mm	796 x 950 x 330	1048 x 950 x 330	796 x 950 x 330	1048 x 950 x 330
	Weight			kg	61	86	61	87
	Air Volume	Cooling	m ³ /min	43	63	47.0	63.0	
		Heating	m ³ /min	41	77	47.0	77.0	
	Sound Level (SPL)	Cooling	dB(A)	45	55	45	53	
		Heating	dB(A)	47	57	47	57	
	Sound Level (PWL)	Cooling	dB(A)	55	66	55	66	
	Breaker Size			A	16	30	16	30
Ext. Piping	Diameter		Liquid / Gas	mm	6.35 x 2 / 9.52 x 2	6.35 x 4 / 12.7 x 1+9.52 x 3	6.35 x 2 / 9.52 x 2	6.35 x 4 / 12.7 x 1+9.52 x 3
	Total Piping Length (max)			m	30	70	30	70
	Each Indoor Unit Piping Length (max)			m	20	25	20	25
	Max. Height			m	15	15	15 (10) ^{*3}	15 (10) ^{*3}
	Chargeless Length			m	30	70	20	25
Guaranteed Operating Range (Outdoor)	Cooling	°C		-10 ~ +46	-10 ~ +46	-10 ~ +46	-10 ~ +46	
	Heating	°C		-25 ~ +24	-25 ~ +24	-25 ~ +24	-25 ~ +24	

^{*1} Refrigerant leakage contributes to climate change. Refrigerant with lower global warming potential (GWP) would contribute less to global warming than a refrigerant with higher GWP, if leaked to the atmosphere. This appliance contains a refrigerant fluid with a GWP equal to 2088. This means that if 1 kg of this refrigerant fluid would be leaked to the atmosphere, the impact on global warming would be 2088 times higher than 1 kg of CO₂, over a period of 100 years. Never try to interfere with the refrigerant circuit yourself or disassemble the product yourself and always ask a professional.

^{*2} Energy consumption based on standard test results. Actual energy consumption will depend on how the appliance is used and where it is located.

^{*3} If the outdoor unit is installed higher than the indoor unit, max. height is reduced to 10m.

^{*4} EER/COP, EEL rank, SEER/SCOP values and energy efficiency class are measured when connected to the indoor units listed below.
 MXZ-2F53VFHZ2 MSZ-LN18VG2 + MSZ-LN35VG2
 MXZ-4F83VFHZ2 MSZ-LN18VG2 + MSZ-LN18VG2 + MSZ-LN25VG2 + MSZ-LN25VG2
 MXZ-2E53VAHZ MSZ-EF18VE + MSZ-EF35VE
 MXZ-4E83VAHZ MSZ-EF18VE + MSZ-EF18VE + MSZ-EF22VE + MSZ-EF25VE

^{*5} Indoor unit compatibility table is shown on page 139-140.

^{*6} Refrigerant leakage contributes to climate change. Refrigerant with lower global warming potential (GWP) would contribute less to global warming than a refrigerant with higher GWP, if leaked to the atmosphere. This appliance contains a refrigerant fluid with a GWP equal to 550. This means that if 1 kg of this refrigerant fluid would be leaked to the atmosphere, the impact on global warming would be 550 times higher than 1 kg of CO₂, over a period of 100 years. Never try to interfere with the refrigerant circuit yourself or disassemble the product yourself and always ask a professional. The GWP of R32 is 675 in the IPCC 4th Assessment Report.

^{*7} SEER and SCOP are based on 2009/125/EC:Energy-related Products Directive and Regulation(EU) No206/2012.

To ensure full capacity in cold and snowy regions...

3 Important Points to Remember When Installing the Outdoor Unit



* RAC/PAC (inc. Air to Water) /MXZ

Wind and snow can significantly reduce capacity.

Be sure to check the information below and install the outdoor unit correctly.

1 Installation Location

Be aware of the prevailing wind direction in winter and install the outdoor unit where it is as sheltered as possible.

Units are easily affected by wind and unit may not be able to run at full capacity

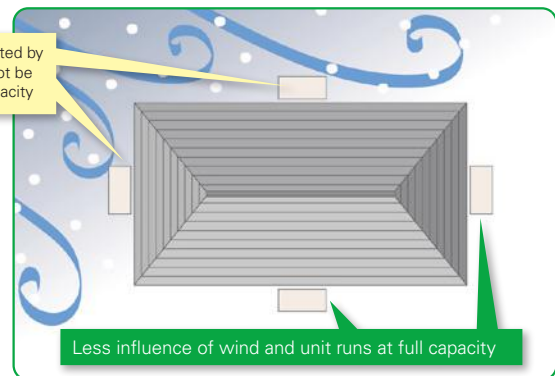

2 Measures for Drainage of Water

Case 1: Unit is installed close to passage (walkway)

Do not install the unit close to passage as drainage water from the unit may freeze and cause a slipping hazard.

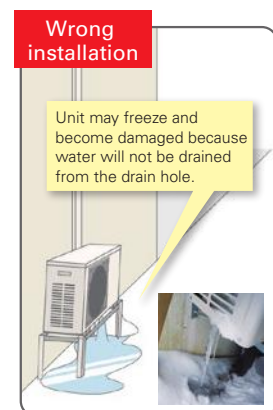
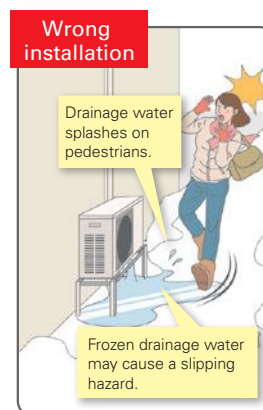
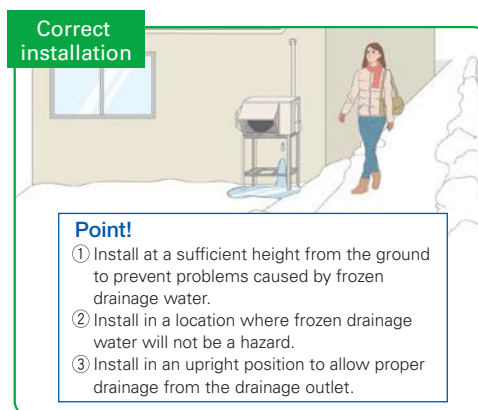

Case 2: Multiple units are installed

Do not install units on top of one another as it may cause frozen drainage water on the bottom unit.

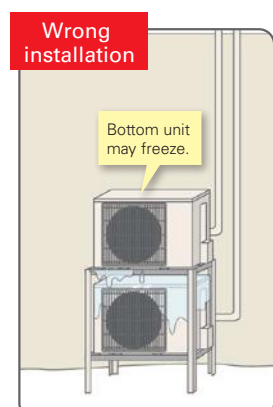
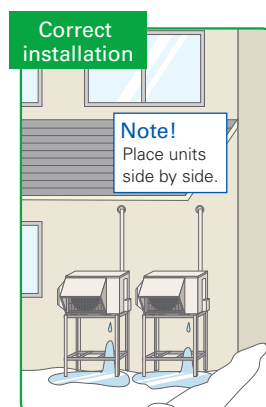

3

Measures for Snow

Unit is installed on the ground

To avoid the adverse effects of snow and frozen drainage water, install the unit on a stand to ensure a sufficient height from the ground.

[RAC / PAC / MXZ]

Correct installation



Point!

- ① Install at a position/height to prevent the unit being buried in snow*1 and the adverse effects of frozen drainage water.*2
 - ② Install so as to avoid the effects of snow or snowdrift.
 - ③ Install so as to avoid the damage from falling snow or icicles.
- *1 Install at a height above the highest snowfall depth.
*2 Even for correct installations, dripping drainage water may form an icicle which needs to be cleared away regularly to prevent a blocked drainage outlet.

Wrong installation

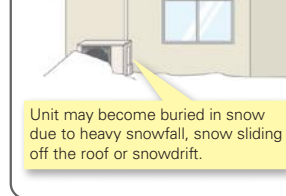

Wrong installation

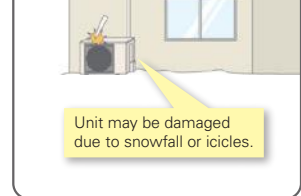

Use a stand to add sufficient height to protect the unit heat exchanger from snow and prevent icicles forming during defrost operation.

Install snow protection hood as necessary

[RAC / PAC / MXZ]

Correct installation

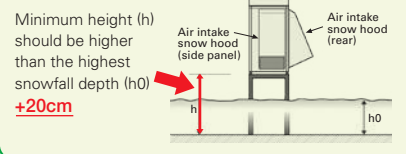

Wrong installation

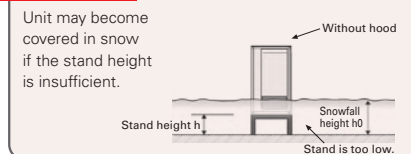

Correct installation

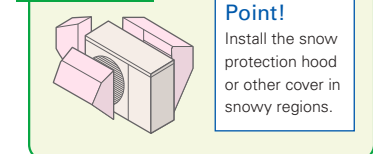

Necessity of accessories (drain socket & centralised drain pan, stand, snow protection hood, base heater)

	Snowy region	Cold region	Remarks
	Countermeasures for snow	Countermeasures for freezing	
Drain socket, Centralised drain pan	Not used	Not used	Prevents freezing
Stand	Needed	Needed	[RAC / PAC / MXZ] 1. Install so as to prevent the unit being buried in snow (at a height greater than the highest snowfall depth). Be sure that the stand does not obstruct drainage. 2. Install so as to prevent damage to the unit due to frozen drainage water (icicles).  < Correct >
Snow protection hood	Needed *When the installation position is subject to snowfall.	—	1. Prevents heat exchanger from being covered in snow. 2. Prevents snow accumulating inside the air duct.
Base heater	—	Needed	[RAC / PAC / MXZ] Outdoor units equipped with a heater for cold regions are those with an "H" in the model name. For the cold-climate zone, use of a unit with a heater is strongly recommended. Even for the moderate-climate zone use of a unit with a heater is recommended for regions subject to high humidity in winter.



CAUTION

About disposal of drainage water

When the unit is installed in cold or snowy regions :

Drainage water may freeze in the drain socket/hose and prevent the fan from rotating.



Do not attach a drain socket packaged as an accessory to the unit.

* In the case that fitting a drain socket is absolutely necessary, steps must be taken so that the drainage water does not freeze. For more information, please consult Mitsubishi Electric or one of its dealers/resellers.

Arrangement for snow protection hood

[RAC / PAC / MXZ]
Separately sold parts are available for some models.
Please consult Mitsubishi Electric or one of its dealers/resellers at the time of purchase for details.

NEW ECODESIGN DIRECTIVE

WHAT IS THE ErP DIRECTIVE?

The Ecodesign Directive for Energy-related Products (ErP Directive) establishes a framework to set mandatory standards for ErPs sold in the European Union (EU). The ErP directive introduces new energy-efficiency ratings across various product categories and affects how products such as computers, vacuum cleaners, boilers and even windows are classified in terms of environmental performance.

Regulations that apply to air conditioning systems of rated capacity up to 12kW came into effect as of January 1, 2013. Based on the use of future-orientated technologies, Mitsubishi Electric is one step ahead of these changes, with our air conditioning systems already achieving compliance with these new regulations.

NEW ENERGY LABEL AND MEASUREMENTS

Under regulation 2011/626/EU, supplementing directive 2010/30/EU, air conditioning systems are newly classified into energy-efficiency classes on the basis of a new energy labelling system, which includes three new classes: A+, A++ and A+++.

Revisions to the measurement points and calculations of the seasonal energy efficiency ratio (SEER) and seasonal coefficient of performance (SCOP) has resulted in changes to how air conditioning systems are classified into energy-efficiency classes.

Specifically, for cooling mode, air conditioning systems must achieve at least class B. For heating mode, air conditioning systems must achieve at least a SCOP value of 3.8.

■ New Energy Efficiency Label

SEER and SCOP
The SEER (Seasonal Energy Efficiency Ratio) value indicates the seasonal energy efficiency ratio in the cooling mode. The SCOP (Seasonal Coefficient of Performance) value refers to the seasonal efficiency in the heating mode.

Energy efficiency classes from A+++ to D SCOP in heating mode

A+++	> 5,1
A++	> 4,6
A+	> 4,0
A	> 3,4
B	> 2,8
C	> 2,3
D	< 2,5

Energy efficiency classes from A+++ to D SEER in cooling mode

A+++	> 8,5
A++	> 6,1
A+	> 5,6
A	> 5,1
B	> 4,6
C	> 4,1
D	< 3,6

Energy efficiency class
Energy efficiency class of the unit in cooling and heating mode of the unit model

In the heating mode, the indication for the unit model is shown for all three climate zones.

Nominal capacity in cooling mode
SEER value
Annual power consumption for cooling

Operating noise, indoors/outdoors
The sound power level is an important sound energy parameter for assessing a sound source. Contrary to the sound pressure - the sound power is independent of the location of the source and/or the receiver. Maximally admissible values are:

Cooling capacity ≤ 6 kW		Cooling capacity > 6 kW ≤ 12 kW	
Indoor unit	Outdoor unit	Indoor unit	Outdoor unit
60dB(A)	65dB(A)	65dB(A)	70dB(A)

Name or trademark of the manufacturer
Name of the unit/designation of model

Time reference
Indication on label data

Nominal capacity in heating mode
SCOP value
Annual power consumption for heating

Climate zones
For heating mode, the EU is divided into three climate zones for calculation and classification purposes. This aims at calculating the energy efficiency taking into consideration the actual regional ambient temperatures.

■ Climate Zones for Heating Mode

Reference climate zones for calculating the SCOP
Since the climate conditions have a great influence on the operating behaviour in the heat pump mode, three climate zones have been stipulated for the EU: warm, moderate, cold. The measurement points are homogenous at 12°C, 7°C, 2°C and -7°C.

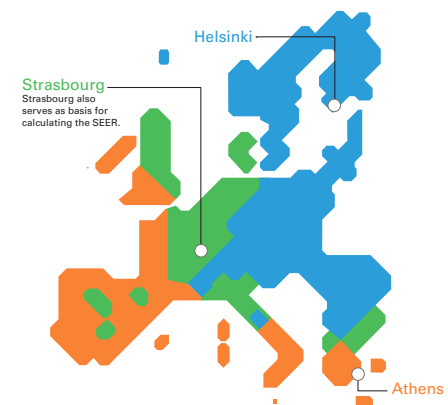

Warm (Athens)

Partial load	Temperature conditions		
	Outdoors	WB	Indoors
-	DB	WB	DB
100%	2°C	1°C	20°C
64%	7°C	6°C	20°C
29%	12°C	11°C	20°C

Moderate (Strasbourg)

Partial load	Temperature conditions		
	Outdoors	WB	Indoors
88%	-7°C	-8°C	20°C
54%	2°C	1°C	20°C
35%	7°C	6°C	20°C
15%	12°C	11°C	20°C

Cold (Helsinki)

Partial load	Temperature conditions		
	Outdoors	WB	Indoors
61%	-7°C	-8°C	20°C
37%	2°C	1°C	20°C
24%	7°C	6°C	20°C
11%	12°C	11°C	20°C

SEER/SCOP

Air conditioning systems were previously assessed using the energy-efficiency rating (EER), which evaluated efficiency in cooling mode, and the coefficient of performance (COP), which defined the efficiency, or the ratio of consumed and output power, in heating mode. Under this system, assessments were not truly reflective of performance as they were based on a single measurement point, which led to manufacturers optimising products accordingly in order to achieve higher efficiency ratings. SEER and SCOP address this problem by including seasonal variation in the ratings via use of realistic measurement points. For cooling mode, measurements at outside temperatures of 20, 25, 30 and 35°C are incorporated and weighted in accordance with climate data for Strasbourg, which is used as a single reference point for the whole EU. For instance, for partial-load operation, which represents more than 90% of operation, there is a correspondingly high weighting for the efficiency classification. For heating mode, a comprehensive temperature profile for the whole EU was not possible, so the EU has been divided into three climate zones, north, central and south, and load profiles created. The same measurement points, at outside temperatures of 12, 7, 2 and -7°C, are used for all three zones.

■ SCOP Calculation

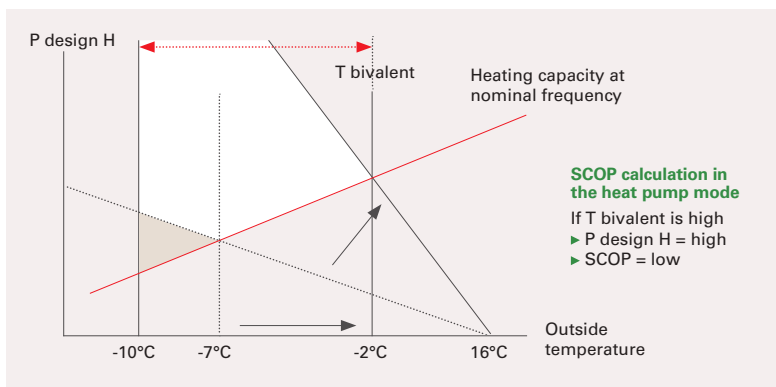

Technical Terms with Respect to the SCOP

P design H: Corresponds to a heating load of 100%. The value depends on the selected bivalence point.

T design: Outside temperature which determines the P design H point. The latter is determined from the area conditions.

T bivalent: Corresponds to the lowest temperature at which full heating performance can be achieved with the heat pump (without additional heating). This point can be freely selected within the prescribed temperature ranges (T design - T bivalent).

SOUND PRESSURE LEVEL

Consumers will also receive more information on the noise levels emitted by split-system air conditioners to help them make their purchasing decision. Specifically, the sound power level of indoor and outdoor units is to be indicated in decibels as an objective parameter. Knowing the sound power makes it possible to calculate sound emissions while considering distance and radiation characteristics, which is beneficial because it allows the noise levels of different air conditioning systems to be compared regardless of the usage location and how the sound pressure is measured. This is an improvement on sound pressure values which are usually measured at an approximate distance of 1 m where all modern split-system air conditioning systems tend to be very quiet at an average of 21 decibels.

■ Sound Pressure vs Sound Power Level

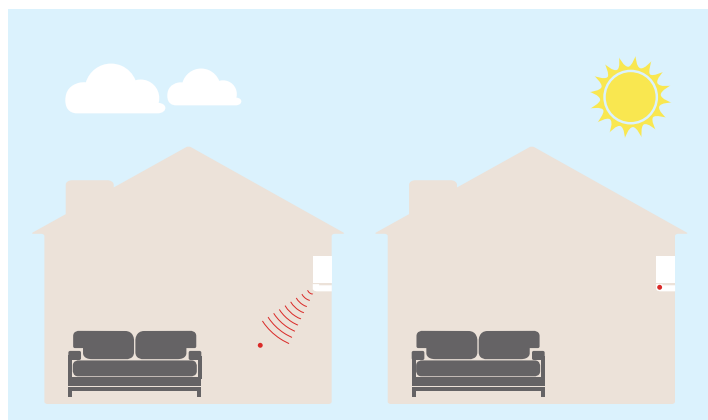

Sound pressure level dB(A)

The sound pressure level is a sound field parameter which indicates the perceived operating noise of an indoor unit within a certain distance.

Sound power level dB(A)

The sound power is an acoustic parameter which describes the source strength of a sound generator and is thus independent of the distance to the receiver location.



INVERTER TECHNOLOGIES

Mitsubishi Electric inverters ensure superior performance including the optimum control of operation frequency. As a result, optimum power is applied in all heating/cooling ranges and maximum comfort is achieved while consuming minimal energy. Fast, comfortable operation and amazingly low running cost – That’s the Mitsubishi Electric promise.

INVERTERS – HOW THEY WORK

Inverters electronically control the electrical voltage, current and frequency of electrical devices such as the compressor motor in an air conditioner. They receive information from sensors monitoring operating conditions, and adjust the revolution speed of the compressor, which directly regulates air conditioner output. Optimum control of operation frequency results in eliminating the consumption of excessive electricity and providing the most comfortable room environment.

ECONOMIC OPERATION

Impressively low operating cost is a key advantage of inverter air conditioners. We’ve combined advanced inverter technologies with cutting-edge electronics and mechanical technologies to achieve a synergistic effect that enables improvements in heating/cooling performance efficiency. Better performance and lower energy consumption are the result.

TRUE COMFORT

Below is a simple comparison of air conditioner operation control with and without an inverter.

■ Inverter operation comparison

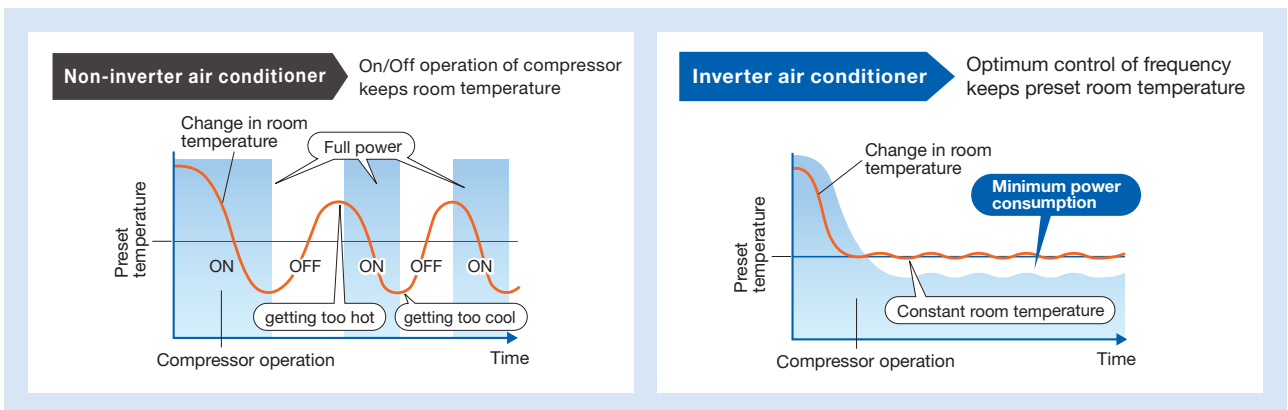

The compressors of air conditioners without an inverter start and stop repeatedly in order to maintain the preset room temperature. This repetitive on/off operation uses excessive electricity and compromises room comfort. The compressors of air conditioners equipped with an inverter run continuously; the inverter quickly optimizing the operating frequency according to changes in room temperature. This ensures energy-efficient operation and a more comfortable room.

Point 1 Quick & Powerful

Increasing the compressor motor speed by controlling the operation frequency ensures powerful output at start-up, brings the room temperature to the comfort zone faster than units not equipped with an inverter. Hot rooms are cooled, and cold rooms are heated faster and more efficiently.

Point 2 Room Temperature Maintained

The compressor motor operating frequency and the change of room temperature are monitored to calculate the most efficient waveform to maintain the room temperature in the comfort zone. This eliminates the large temperature swings common with non-inverter systems, and guarantees a pleasant, comfortable environment.

KEY TECHNOLOGIES

Our Rotary Compressor

Our rotary compressors use our original “Poki-Poki Motor” and “Heat Caulking Fixing Method” to realise downsizing and higher efficiency, and are designed to match various usage scenes in residential to commercial applications. Additionally, development of an innovative production method known as “Divisible Middle Plate” realises further size/weight reductions and increased capacity while also answering energy-efficiency needs.

Our Scroll Compressor

Our scroll compressors are equipped with an advanced frame compliance mechanism that allows self-adjustment of the position of the orbiting scroll according to pressure load and the accuracy of the fixed scroll position. This minimises gas leakage in the scroll compression chamber, maintains cooling capacity and reduces power loss.

MORE ADVANTAGES WITH MITSUBISHI ELECTRIC



Joint Lap DC Motor

Mitsubishi Electric has developed a unique motor, called the "Poki-Poki Motor" in Japan, which is manufactured using a joint lapping technique. This innovative motor operates based on a high-density, high-magnetic force, leading to extremely high efficiency and reliability.



Magnetic Flux Vector Sine Wave Drive

This drive device is actually a microprocessor that converts the compressor motor's electrical current waveform from a conventional waveform to a sine wave (180° conduction) to achieve higher efficiency by raising the motor winding utilisation ratio and reducing energy loss.



Reluctance DC Rotary Compressor

Powerful neodymium magnets are used in the rotor of the reluctance DC motor. More efficient operation is realised by strong magnetic and reluctance torques produced by the magnets.

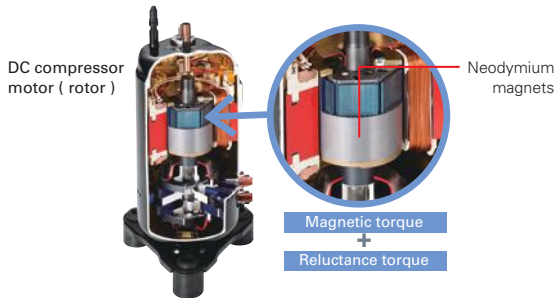

Highly Efficient DC Scroll Compressor

Higher efficiency has been achieved by adding a frame compliance mechanism to the DC scroll compressor. The mechanism allows movement in the axial direction of the frame supporting the cradle scroll, thereby greatly reducing leakage and friction loss, and ensuring extremely high efficiency at all speeds.

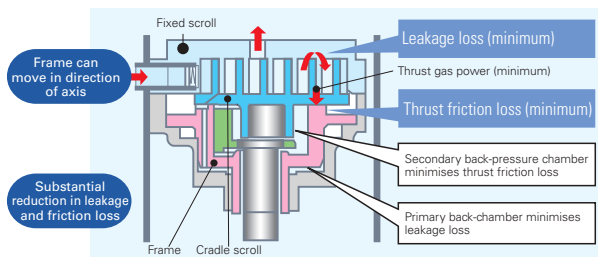

Heat Caulking Fixing Method

To fix internal parts in place, a "Heat Caulking Fixing Method" is used, replacing the former arc spot welding method. Distortion of internal parts is reduced, realising higher efficiency.



DC Fan Motor

A highly efficient DC motor drives the fan of the outdoor unit. Efficiency is much higher than an equivalent AC motor.



Vector-Wave Eco Inverter

This inverter monitors the varying compressor motor frequency and creates the most efficient waveform for the motor speed. As the result, operating efficiency in all speed ranges is improved, less power is used and annual electricity cost is reduced.

Smooth wave pattern

Inverter size has been reduced using insert-molding, where the circuit pattern is molded into the synthetic resin. To ensure quiet operation, soft PWM control is used to prevent the metallic whine associated with conventional inverters.

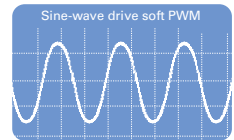

PAM (Pulse Amplitude Modulation)

PAM is a technology that controls the current waveform so that it resembles the supply voltage wave, thereby reducing loss and realising more efficient use of electricity. Using PAM control, 98% of the input power supply is used effectively.

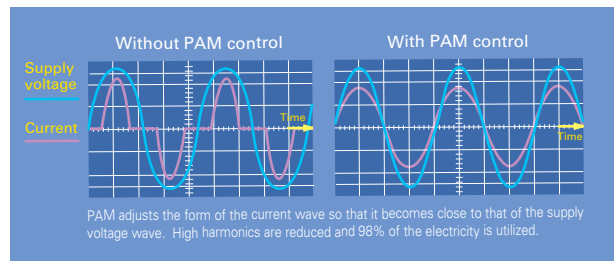

Merits of PAM Control

Significant energy savings
Remarkable reduction in power loss saves electricity

Limited energy savings
Electricity is wasted

Power increased
Efficient voltage increase realises increased power

Limited power
Insufficient power when needed



Power Receiver and Twin LEV Control

Mitsubishi Electric has developed a power receiver and twin linear expansion valves (LEVs) circuit that optimise compressor performance. This technology ensures optimum control in response to operating waveform and outdoor temperature. Operating efficiency has been enhanced by tailoring the system to the characteristics of R410A refrigerant.

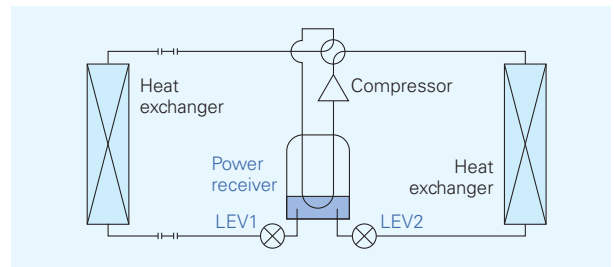

Grooved Piping

High-performance grooved piping is used in heat exchangers to increase the heat exchange area.

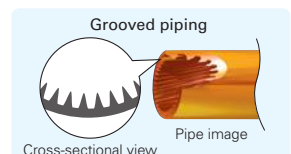

COMFORT

3D i-see Sensor

3D i-see Sensor for M SERIES

The LN Series and FH Series are equipped with the 3D i-see Sensor, an infrared-ray sensor that measures the temperature at distant positions. While moving to the left and right, eight vertically arranged sensor elements analyze the room temperature in three dimensions. This detailed analysis makes it possible to judge where people are in the room, thus allowing creation of features such as "Indirect airflow," to avoid airflow hitting people directly, and "direct airflow" to deliver airflow to where people are.

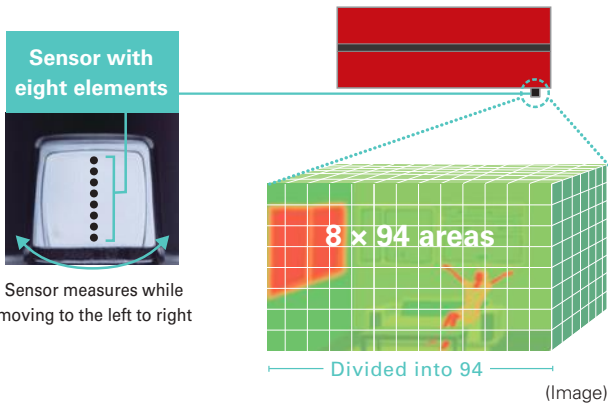

No occupancy energy-saving mode

The sensors detect whether there are people in the room. When no-one is in the room, the unit automatically switches to energy-saving mode.

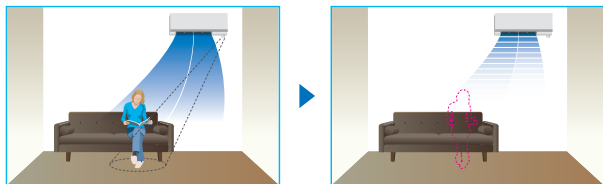

The "3D i-see Sensor" detects people's absence and the power consumption is automatically reduced approximately 10% after 10 minutes and 20% after 60 minutes.

Indirect Airflow

The indirect airflow setting can be used when the flow of air feels too strong or direct. For example, it can be used during cooling to avert airflow and prevent body temperature from becoming excessively cooled.

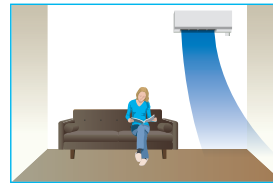

Direct Airflow

This setting can be used to directly target airflow at people such as for immediate comfort when coming indoors on a hot (cold) day.

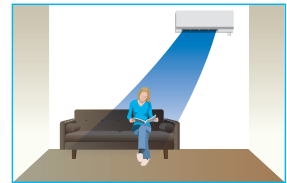

Even Airflow *LN Series only

Normal swing mode

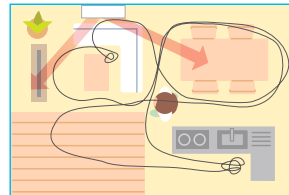

The airflow is distributed equally throughout the room, even to spaces where there is no human movement.

Even airflow mode

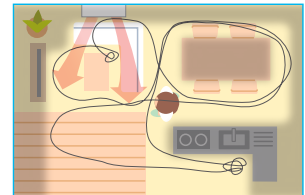

The 3D i-see sensor memorizes human movement and furniture positions, and efficiently distributes airflow.

No occupancy Auto-OFF mode *LN Series only

The sensors detect whether or not there are people in the room. When there is no one in the room, the unit turns off automatically.

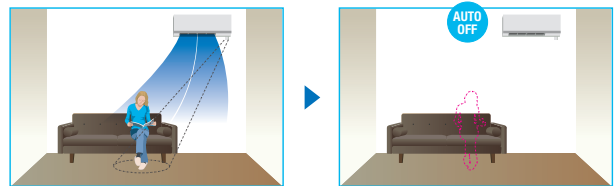

3D i-see Sensor for S & P SERIES

Detects number of people

The 3D i-see Sensor detects the number of people in the room and adjusts the power accordingly. This makes automatic power-saving operation possible in places where the number of people changes frequently. Additionally, when the area is continuously unoccupied, the system switches to a more enhanced power-saving mode. Depending on the setting, it can also stop the operation.

Detects people's position

Once a person is detected, the angle of the vane is automatically adjusted. Each vane can be independently set to "Direct Airflow" or "Indirect Airflow" according to taste.

Highly accurate people detection

A total of eight sensors rotate a full 360° in 3-minute intervals. In addition to detecting human body temperature, our original algorithm also detects people's positions and the number of people.



Detects number of people

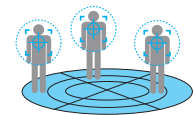

Detects people's position

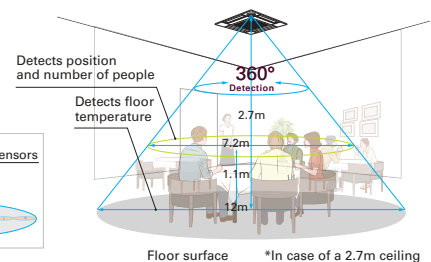
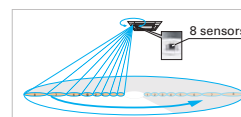
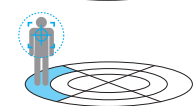

Detects number of people

Room occupancy energy-saving mode

The 3D i-see Sensor detects the number of people in the room. It then calculates the occupancy rate based on the maximum number of people in the room up to that point in time in order to save air-conditioning power. When the occupancy rate is approximately 30%, air-conditioning power equivalent to 1°C during both cooling and heating operation is saved. The temperature is controlled according to the number of people.

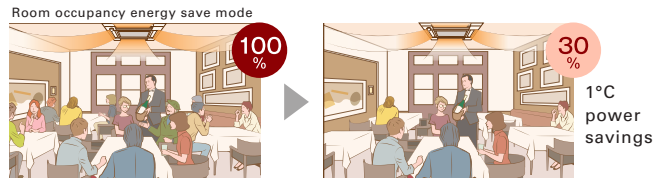

No occupancy energy-saving mode

When 3D i-see Sensor detects that no one is in the room, the system is switched to a pre-set power-saving mode. If the room remains unoccupied for more than 60min, air-conditioning power equivalent to 2°C during both cooling and heating operation is saved. This contributes to preventing waste in terms of heating and cooling.

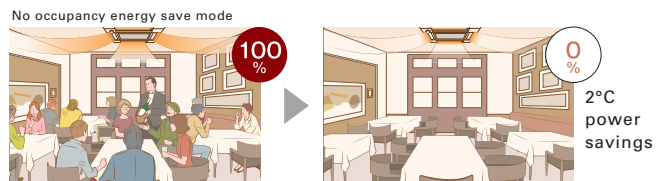

No occupancy Auto-OFF mode*

When the room remains unoccupied for a pre-set period of time, the air conditioner turns off automatically, thereby providing even greater power savings. The time until operation is stopped can be set in intervals of 10min, ranging from 60 to 180 min.

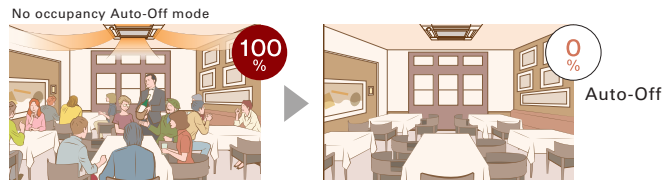

*When MA Remote Controller is used to control multiple refrigerant systems, "No occupancy Auto-OFF mode" cannot be used.

*PAR-41MAA is required for each setting

Detects people's position

Direct/Indirect settings*

The horizontal airflow spreads across the ceiling. When set to "Indirect Airflow" uncomfortable drafty-feeling is eliminated!

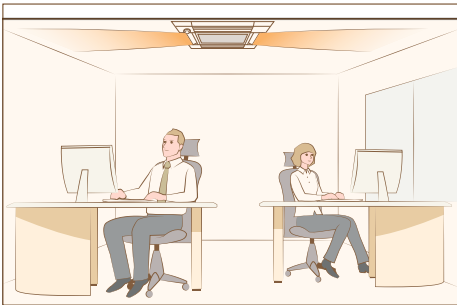

*PAR-41MAA or PAR-SL101A-E is required for each setting.

Seasonal airflow*

When cooling

Saves energy while keeping a comfortable effective temperature by automatically switching between ventilation and cooling. When a pre-set temperature is reached, the air conditioning unit switches to swing fan operation to maintain the effective temperature. This clever function contributes to keeping a comfortable coolness.

When heating

The air conditioning unit automatically switches between circulator and heating. Wasted heat that accumulates near the ceiling is reused via circulation. When a pre-set temperature is reached the air conditioner switches from heating to circulator and blows air in the horizontal direction. It pushes down the warm air that has gathered near the ceiling to people's height, thereby providing smart heating.

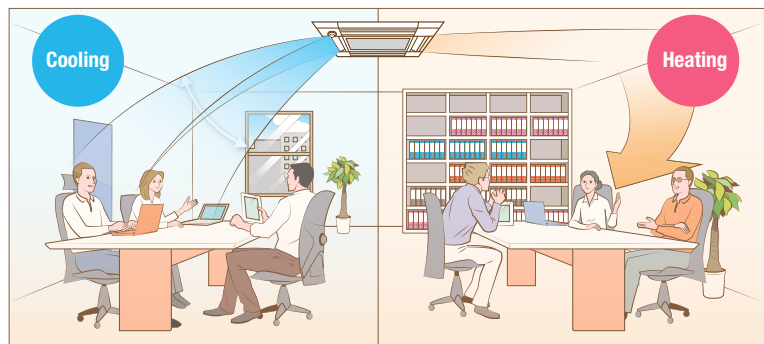

*PAR-41MAA is required for each setting.

AREA Area Temperature Monitor

The "3D i-see Sensor" monitors the whole room in sections and directs the airflow to areas of the room where the temperature does not match the temperature setting. (When cooling the room, if the middle of the room is detected to be hotter, more airflow is directed towards it.) This eliminates unnecessary heating/cooling and contributes to lower electricity costs.

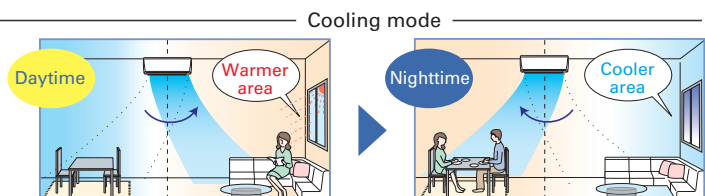

COMFORT

3D TOTAL FLOW

3D Total Flow*

3D Total Flow is an innovative function. Our original 3D i-see sensor detects the temperature of the floor, and then the newly installed 3D Total Flow unit automatically controls the airflow in the left/right directions in a smart manner.

*3D Total Flow unit(PLP-U160ELR-E) cannot be used with Plasma Quad Connect(PAC-SK51FT-E), Insulation kit(PAC-SK36HK-E), Shutter Plate(PAC-SJ37SP-E), Multi functional casement(PAC-SJ41TM-E) and High-efficiency filter element(PAC-SH59KF-E)

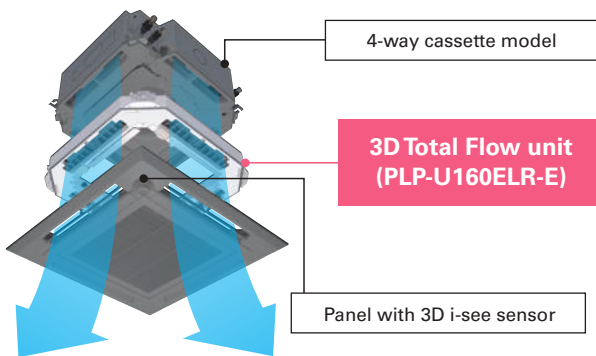

Horizontal louver (3D Total Flow)

In addition to the ability of conventional models to control airflow in the vertical direction, the adoption of a horizontal louver unit allows each outlet to blow air over a horizontal angle of 90 degrees. The combination of four outlets delivers 360° airflow control around the entire circumference. This now makes it possible to blow air in diagonal directions which eliminates temperature irregularities.

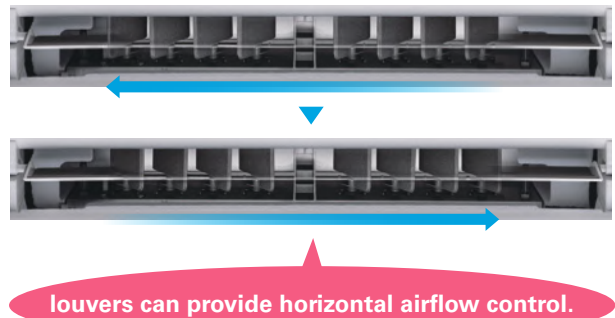

Fine-tuned sensing & airflow direction control (3D Total Flow)

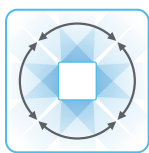

Swinging

Since airflow can be controlled in the horizontal and vertical directions, you can efficiently make the entire room comfortable.

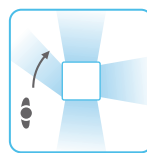

Indirect mode

When set to "Indirect" mode, the system detects the position of a person and maintains comfort while diverting airflow away from them.

Horizontal, vertical, and diagonal airflow delivered to every corner

The combination of the vertical vanes with the horizontal louver unit makes it possible to direct airflow in any direction. This quickly makes the entire room comfortable, even when diagonal airflow is necessary.

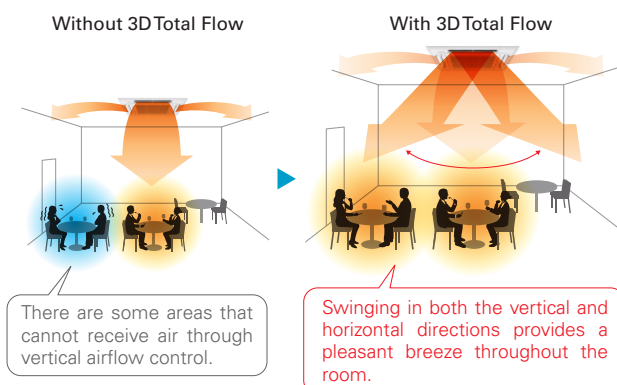

Prevents direct airflow and keeps you comfortable

This function prevents people from being directly exposed to airflow while still ensuring comfort. The "Indirect" mode of 3D Total Flow keeps the downward airflow while avoiding direct blow to people, delivering a pleasant warmth.

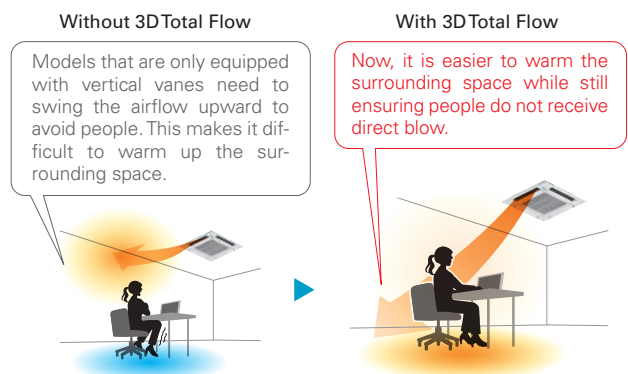

*If people are present throughout the entire airflow range of an outlet, the airflow is shifted horizontally to avoid direct airflow.

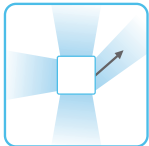

Targeting

The system can detect spaces with uneven temperatures and target them by sending air even if they are in a diagonal direction.

Detects and targets areas with uneven temperatures

3D i-see sensor detects areas with uneven temperatures, even if they are caused by the installation orientation of the air conditioner or the influence of strong sunlight. Efficient air conditioning is possible thanks to the ability to send focused airflow to such areas, even those in a diagonal position.

Without 3DTotal Flow

Depending on application, conventional systems may take a long time to cool down hot spots.

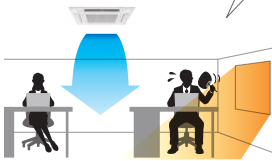

With 3DTotal Flow

The new system efficiently eliminates hot spots by using targeted airflow.

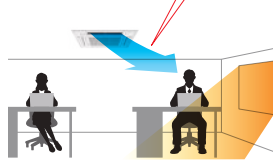

Direct mode

When set to "Direct" mode, the system detects the position and diverts airflow towards wherever they are located.

Delivers airflow even in diagonal directions

You can freely turn on "Direct" mode depending on personal preference. This allows for air conditioning in diagonal directions which was difficult for models that could only swing the airflow up and down. This feature is perfect for when you come back home on a hot day.

Without 3DTotal Flow

It is difficult to direct airflow in diagonal directions when only using vertical vanes.

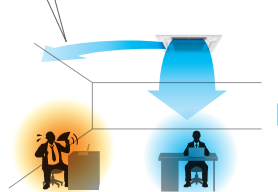

With 3DTotal Flow

Ensures comfort even when you are located diagonally from an outlet.

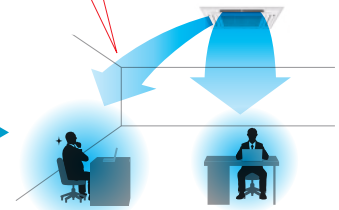

COMFORT

ENERGY-SAVING



Econo Cool Energy-Saving Feature

“Econo Cool” is an intelligent temperature control feature that adjusts the amount of air directed towards the body based on the air-outlet temperature. The setting temperature can be raised by as much as 2°C without any loss in comfort, thereby realising a 20% gain in energy efficiency. (Function only available during manual cooling operation.)

	Conventional	Econo Cool
Ambient temperature	35°C	35°C
Set temperature	25°C	27°C
Perceived temperature	30°C	29.3°C

Econo Cool Mode

A comfortable room environment is maintained even when setting the temperature 2°C higher than the conventional cooling mode.

Econo Cool on



Conventional cooling mode



Temperature distribution (°C)

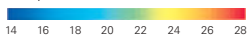

Demand Function (Onsite Adjustment)

The demand function can be activated when the unit is equipped with a commercially available timer or an On/Off switch is added to the CNDM connector (option) on the control board of the outdoor unit. Energy consumption can be reduced up to 100% of the normal consumption according to the signal input from outside.

[Example: Power Inverter Series]

Limit energy consumption by changing the settings of SW7-1, SW2 and SW3 on the control board of the outdoor unit. The following settings are possible.

SW7-1	SW2	SW3	Energy consumption
ON	OFF	OFF	100%
	ON	OFF	75%
	ON	ON	50%
	OFF	ON	0% (Stop)

*PUHZ outdoor only

AIR DISTRIBUTION



Double Vane

Double vane separates the airflow in the different directions to deliver airflow not only across a wide area of the room, but also simultaneously to two people in different locations.



Horizontal Vane

The air outlet vane swings up and down so that the airflow is spread evenly throughout the room.



Vertical Vane

The air outlet fin swings from side to side so that the airflow reaches every part of the room.



High Ceiling Mode

In the case of rooms with high ceilings, the outlet-air volume can be increased to ensure that air is circulated all the way to the floor.



Low Ceiling Mode

If the room has a low ceiling, the airflow volume can be reduced for less draft.



Auto Fan Speed Mode

The airflow speed mode adjusts the fan speed of the indoor unit automatically according to the present room conditions.



Circulator Mode

After reaching the target temperature, heating mode will automatically switch to circulator mode, which makes the unit go into “fan-only” state and mixes warm air to eliminate uneven temperature in the room.



AIR QUALITY

Plasma Quad Plus

Plasma Quad Plus is a plasma-based filter system that effectively removes six kinds of air pollutants. Plasma Quad Plus captures mold and allergens more effectively than Plasma Quad. It can also capture PM2.5 and particles smaller than 2.5µm, creating healthy living spaces for all.

Bacteria

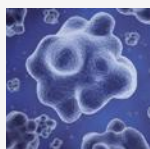

<LN series>
Neutralizes 99% of Staphylococcus aureus in 162 minutes in a 25 m³ test space.
Test No.2016-0118
tested by KRCEs-Bio.

<AY series>
Neutralizes 99% of Staphylococcus aureus in 186 minutes in a 25 m³ test space.
Test No.22046475001-0301
tested by KRCEs-Bio.

Viruses

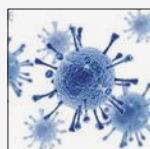

<LN series>
Neutralized 99.8% of SARS-CoV-2 in 360 minutes.*1
Test No.20KB070569
tested by Japan Textile Products Quality and Technology Center
Neutralizes 99% of Influenza A virus particles in 72minutes in a 25 m³ test space.
Test No.28-002
tested by vrc.center, SMC

<AY series>
Neutralized 99.8% of SARS-CoV-2 in 360 minutes.*1
Test No.20KB070569
tested by Japan Textile Products Quality and Technology Center
Neutralizes 99% of Influenza A virus particles in 210.5minutes in a 25 m³ test space.
Test No. R4-001
tested by National Hospital Organization Sendai Medical Center

Molds



<LN series>
Neutralizes 99% of Penicillium citrinum in 135 minutes in a 25 m³ test space.
Test No. 16069353001-0201
tested by Japan Food Research Laboratories

<AY series>
Neutralizes 99% of Penicillium citrinum in 251 minutes in a 25 m³ test space.
Test No.22046475001-0401
tested by Japan Food Research Laboratories

Allergens



<LN series>
Neutralizes 98% of cat fur and pollen.*1
Test No. T1606028
tested by ITEA Inc.

<AY series>
Neutralizes 98% of cat fur and pollen.*1
Test No. T1606028
tested by ITEA Inc.

PM2.5



<LN series>
Neutralizes 90% of PM2.5 particles in 83minutes, 99% of PM2.5 particles in 166minutes in a 28 m³ test space.
In-Company Investigation

<AY series>
Neutralizes 90% of PM2.5 particles in 189 minutes, 99% of PM2.5 particles in 378 minutes in a 28 m³ test space.
Test No. LSRL 21010 F105
tested by Life Science Research Laboratory (Japan)

Dust



<LN series>
Neutralizes 99.7% of dust and mites.*1
Test No.T1606028
tested by ITEA Inc.

<AY series>
Neutralizes 99.7% of dust and mites.*1
Test No.T1606028
tested by ITEA Inc.

*1 The test was conducted on the Plasma Quad Plus device alone, not designed to evaluate product performance so LN and AY series have the same result.

Image of Plasma Quad Plus

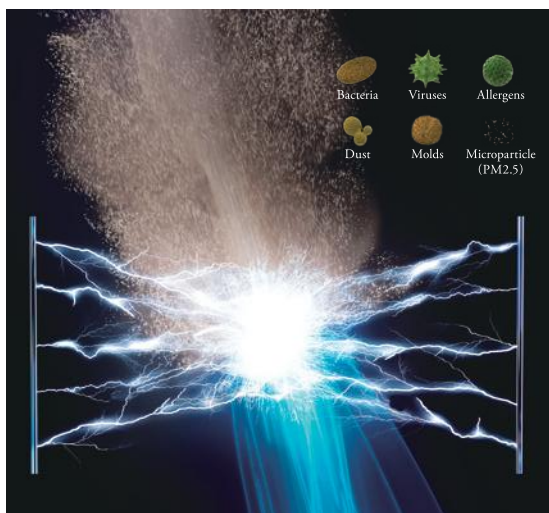

Principle of Plasma Quad Plus

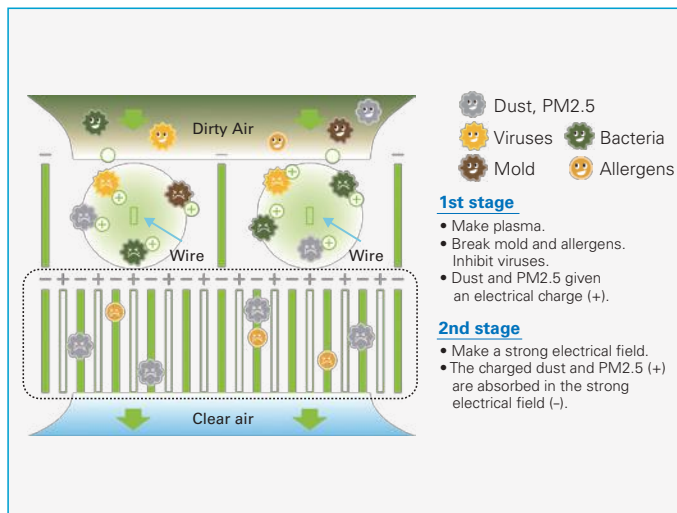







Hi-performance Plasma Filtration System

Plasma Quad Connect (Optional Parts)

Plasma Quad Connect is an high-performance air purifying device which can even be installed on the existing units, contributing to a better air quality in your room. Plasma Quad Connect applies a voltage of 6,000 volts to the electrode to generate plasma, effectively removing various kinds of particles such as viruses, bacteria, molds, allergens, dust, and PM2.5.







 Virus 99% inhibited*1 *2	 Bacteria 99% inhibited*2
 Mold 99% inhibited*2	 Dust 99.7% inhibited
 Allergen 98% inhibited	 PM2.5 99% inhibited*2

*1 The result of test with Influenza A virus.

*2 The result is based on the test with a device installed on the representative indoor unit. (MSZ-AP series)

Specifications

Model Name	MAC-100FT-E	PAC-HA11PAR, PAC-HA31PAR PAC-HA21PAU, PAC-HA31PAU (Attachment for Ducted Indoor Units)*1, *3	PAC-KE91PTB-E, PAC-KE92PTB-E PAC-KE93PTB-E, PAC-KE94PTB-E PAC-KE95PTB-E (Box for Ducted Indoor Units)*1, *3	PAC-SK51FT-E ¹⁴	SLP-2FAP, SLP-2FALP SLP-2FALMP2
Product Image		 *5	 *5		 *5
Compatible with	MSZ, PKA, and PKFY *2 (Wall mounted models)	SEZ, PEAD, and PEFY *2	PEAD, and PEFY *2	PLA and PLFY *2 (4-way Cassette 3x3 models)	SLZ, and PLFY *2 (2x2 Cassette)
Input Voltage	Single Phase AC220~240V	—	—	Single Phase AC220~240V	Single Phase AC220~240V
Frequency	50/60Hz	—	—	50/60Hz	50/60Hz
Power Consumption	4W	—	—	4W	4W
Size H×W×D	56mm × 499.5mm × 168mm	—*6	247mm × 917mm × 179mm*7	134mm × 840mm × 840mm	20mm × 625mm × 625mm
Weight	1,600g	360g*6	4,570g*7	8,700g	4,400g

*1 Both MAC-100FT-E and PQ Attachment or PQ box will be required when using with ducted models. *2 Please contact your nearest sales office about compatible model. *3 Specifications are subject to change without notice.

*4 When multi-functional casement or automatic filter elevation panel is used/installed, PAC-SK51FT-E can not be used. *5 The image shows rear suction. *6 Depends on model. Shows weight of PAC-HA11PAR.

*7 Depends on model. Shows size/weight of PAC-KE92PTB-E. *8 Plasma Quad Connect cannot be used with PAC-SK54/46KFE (V blocking filter).

Test Report Results

Following test results were conducted under controlled laboratory conditions. Performance might differ in real life environment.

Tested Materials	Tested Standard	Capacity	Time	Result	Testing Organization	Test Report	
Virus	New Coronavirus (SARS-CoV-2)	Original	—*8	360min	99.8% inhibited*9	Japan Textile Products Quality and Technology Center	20KB070569
	Influenza A	JEM1467	25m ³	175min	99% inhibited*10	SMC Virus Research Center Japan (JAPAN)	R2-003
Bacteria	Staphylococcus Aureus	GB21551.6-2010	30m ³	335min	99% inhibited*10	CHEARI (Beijing) Certification & Testing Co., Ltd.	WK-21-50161
Mold	Penicillium Citrinum	JEM1467	25m ³	160min	99% inhibited*10	Life Science Research Laboratory (JAPAN)	LSRL-51021E-E091
Allergen	Cat Fur and Pollen	Original	—*8	—	98% inhibited*11	Institute of Tokyo Environmental Allergy (JAPAN)	No.T1606028
Dust	Dust and Mites	Original	—*8	—	99.7% inhibited*11	Institute of Tokyo Environmental Allergy (JAPAN)	No.T1606028
PM2.5	Cigarette smoke	JEM1467	25m ³	300min	99% inhibited*10	Life Science Research Laboratory (JAPAN)	SRL-21010E-E091

*8 The test was conducted on the Plasma Quad device alone, not designed to evaluate product performance. *9 The result without the effect of natural attenuation is 96.3%.

*10 The result is based on the test with a device installed on the representative indoor unit. (MSZ-AP series) *11 It shows the result when allergen and dust pass through the device once.

AIR QUALITY

Self Clean mode

When Self Clean Mode is activated, fan operation starts after cooling/dry mode. This operation helps to dry inside indoor unit to prevent molds and odors. You can feel the clean air without frequent cleaning by yourself.

① High humidity inside the unit, which can lead to mold growth and odors.

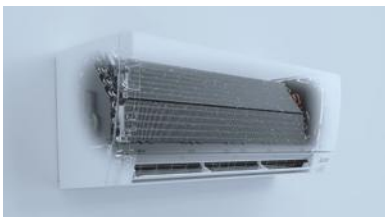

② Airflow operation suppresses mycelial growth.

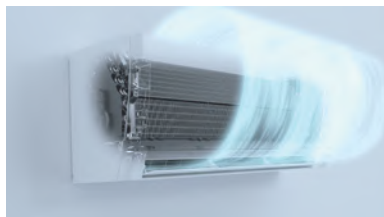

③ Maintains clean unit interior.



Filters & Cleaning Functions

Fresh-air Intake

Indoor air quality is enhanced by the direct intake of fresh exterior air.

High-efficiency Filter

This high-performance filter has a much finer mesh compared to standard filters, and is capable of capturing minute particulates floating in the air that were not previously caught.

Air Purifying Filter

The filter has a large capture area and also generates antibacterial, antifungal, and deodorant effects.

Oil Mist Filter

The oil mist filter prevents oil mist from penetrating into the inner part of the air conditioner.

Long-life Filter

A special process for the entrapment surface improves the filtering effect, making the maintenance cycle longer than that of units equipped with conventional filters.

Filter Check Signal

Air conditioner operating time is monitored, and the user is notified when filter maintenance is necessary.

Silver-ionized Air Purifier Filter

Silver-ionized Air Purifier Filter made of non-woven fabric can capture tiny particles. Silver ions and enzymes contained in the filter effectively act on bacteria and allergens and neutralises them.

Dual Barrier Coating

A two-barrier coating which prevents hydrophobic and hydrophilic dirt from sticking to the inner surface and inner parts of the indoor unit.

Dual Barrier Material

Antifouling materials are kneaded into horizontal vane and vertical vane, preventing dust and greasy dirt accumulating on the surface of indoor unit.

Deodorising Filter

The catalyst in the Deodorising Filter denatures the odorous components and destroys them from the source of the odour, quickly delivering fresh air to your room.

V Blocking Filter

V Blocking Filter with antiviral effect inhibits 99% of adhered virus, and other harmful substances, such as bacteria, mold and allergen. Two-layered filter with non-woven fabric and electrostatic filter can effectively capture and remove small particles from the air in your room.



AIR QUALITY

Plasma Quad Protect

Provide clean air and protection for your indoor air quality around the clock without taking up floorspace.



JC-4K-EU

Plasma Quad Technology

Plasma Quad technology was developed by Mitsubishi Electric in 2012. It suppresses airborne viruses, bacteria and allergens as they pass through an electrical field that is generated by applying DC voltage to a discharger comprising a discharging electrode and counter electrode.

Simple & Floorspace-saving Installation

No duct work is needed, and no floorspace is taken up.

■ Cross-sectional image of ceiling installation

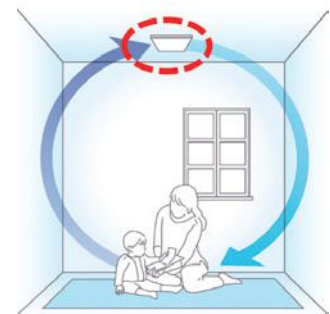
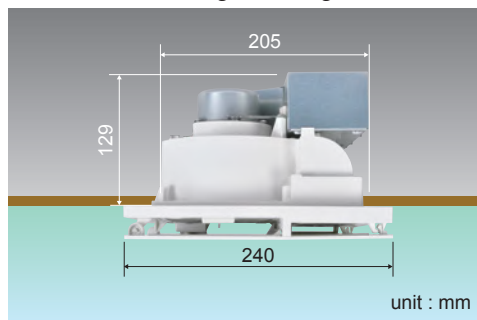

Structure

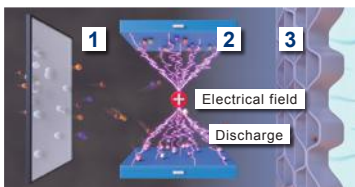

- 1 Large particles are collected by the filter.
- 2 Particles that pass through the filter are suppressed and collected by the Plasma Quad device.
- 3 Clean air is released into the room.

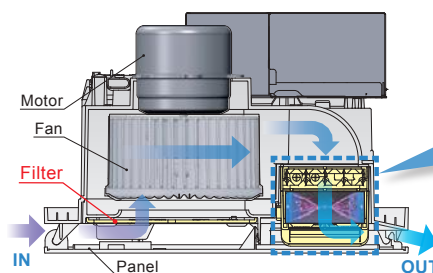

■ Plasma Quad Device

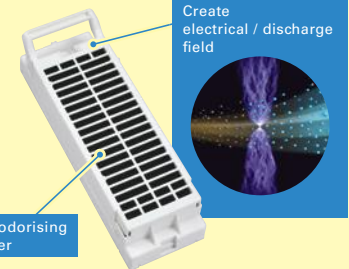

Maintenance-saving

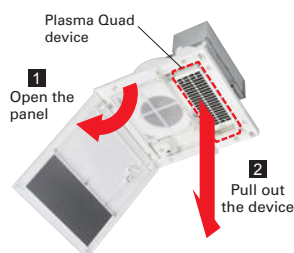

- Rinse with water or lukewarm water. (Neutral detergent is available)
- Soak the deodorising filter in water for about 30 minutes. (This soaking time is a rough estimate.)

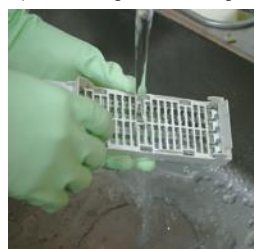

Dual Barrier Coating

Dual Barrier Coating effectively prevents buildup of dust and dirt in the fan.

- Comparison of the buildup of dust and dirt containing moisture on fan blades after 10 years of operation. (Test according to Mitsubishi Electric standards)

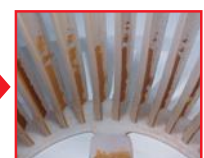

Without coating

Dual Barrier Coating

Specifications

JC-4K-EU type



Key Features

- Plasma Quad Device
- Dual Barrier Coating
- Low Noise Operation and Energy Efficiency
- Installed to Ceiling and Wall

■ Dimensions

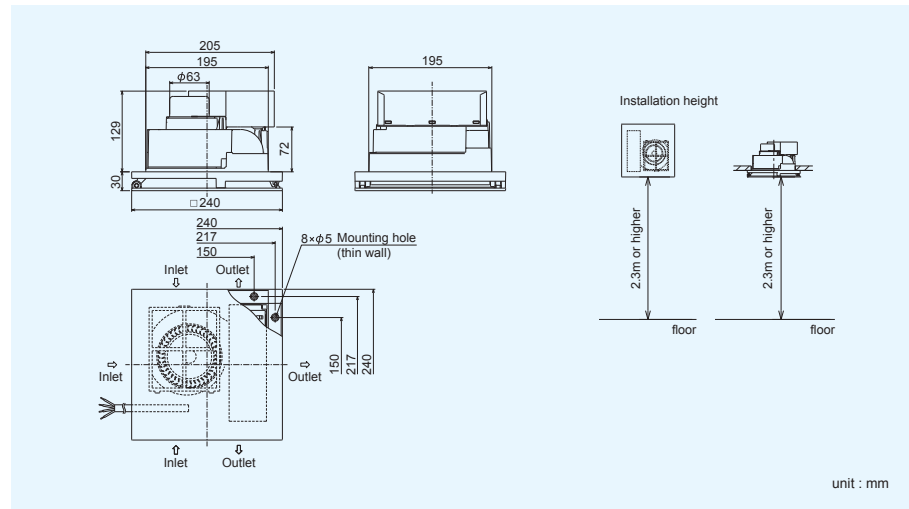

■ Specifications

Model	Voltage	Fan speed	Power consumption [W]	Air volume [m ³ /h]	Noise level [dB]	Weight [kg]
JC-4K-EU	220V	High	11.5	38	35	2.4
		Low	7.5	19	20	
	230V	High	12.5	40	36.5	
		Low	8	20	21	
	240V	High	13.5	42	38.5	
		Low	8.5	21	22	

Test Report Results

Following test results were conducted under controlled laboratory conditions. Performance might differ in real life environment

Tested Materials	Tested Standard	Capacity	Time	Result	Testing Organization	Test Report	
Virus	SARS-CoV-2	New Coronavirus (SARS-CoV-2)	—	480min	99.4% suppression ¹	Japan Textile Products Quality and Technology Center	20KB070532
	Influenza A	JEM1467	25m ³	416min	99% suppression	Sendai Medical Center	R2-001
Bacteria	<i>Staphylococcus aureus</i>	JEM1467	25m ³	388min	99% suppression	Kitasato Research Center for Environmental Science	No.2015_0046
Allergen	Pollen	Original	—	—	88% suppression ²	Institute of Tokyo Environmental Allergy	15M-RPTMAY021
PM2.5	Cigarette smoke	JEM1467	27.5m ³	370min	99% suppression	Mitsubishi Electric	—

* 1 It shows the result against the virus attached to the testing equipment which using the plasma quad technology.

* 2 The test was conducted on the Plasma Quad device only.It shows the result when allergen pass through the device once.

CONVENIENCE

CONVENIENCE

"i save" Mode

"i save" is a simplified setting function that recalls the preferred (preset) temperature by pressing a single button on the remote controller. Press the same button twice in repetition to immediately return to the previous temperature setting.

Using this function contributes to comfortable waste-free operation, realising the most suitable air conditioning settings and saving on power consumption when, for example, leaving the room or going to bed.

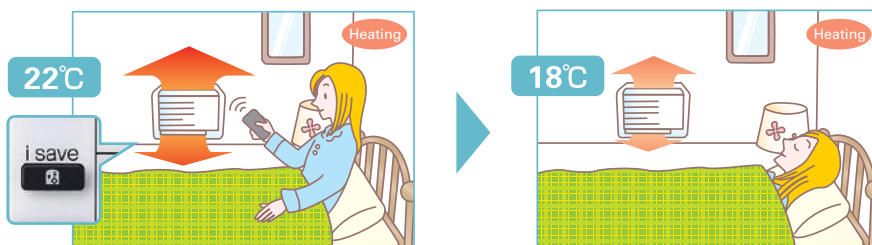

* Temperature can be preset to 10°C when heating in the "i-save" mode.

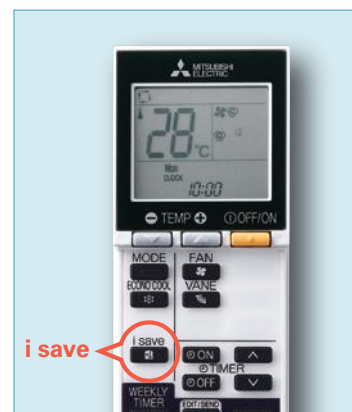

Auto Changeover

The air conditioner automatically switches between heating and cooling modes to maintain the desired temperature.

Low-temperature Cooling

Intelligent fan speed control in the outdoor unit ensures optimum performance even when the outside temperature is low.

Ampere Limit Adjustment

Dip switch settings can be used to adjust the maximum electrical current for operation. This function is highly recommended for managing energy costs.

* Maximum capacity is lowered with the use of this function.

Operation Lock (Indoor unit)

To accommodate specific-use applications, cooling or heating operation can be specified using the wireless remote controller. A convenient option when a system needs to be configured for exclusive cooling or heating service.

Operation Lock (Outdoor unit)

To accommodate specific-use applications, cooling or heating operation can be specified when setting the control board of the outdoor unit. A convenient option when a system needs to be configured for exclusive cooling or heating service.

Auto Restart

Especially useful at the time of power outages, the unit turns back on automatically when power is restored.

10°C Heating

During heating operation, the temperature can be set in 1°C increments down to 10°C.

* MLZ and MFZ series: Only when using "i-save" mode, the temperature can be set to 10°C, but not in 1°C increments.

Dip Switch Setting (Board for MXZ-5E102)

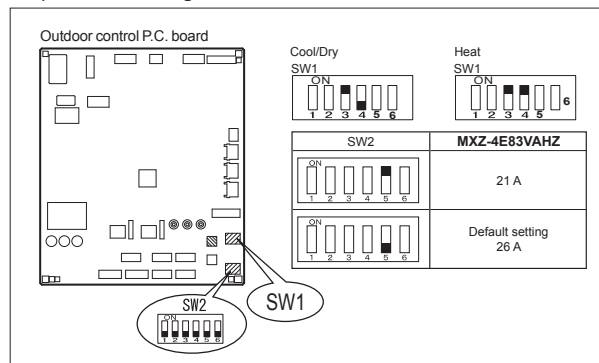

Night Mode

When Night Mode is activated using the wireless remote controller, it will switch to the settings described below.

- The brightness of the operation indicator lamp will become dimmer.
- The beeping sound will be disabled.
- The outdoor operating noise will drop to 3dB lower than the rated specification operating noise.

*The cooling/heating capacity may drop.

*Night mode does not function when connected to MXZ.

Low-noise Operation (Outdoor Unit)

System operation can be adjusted to prioritise less noise from the outdoor unit over air conditioning performance.

On/Off Operation Timer

Use the remote controller to set the times of turning the air conditioner On/Off.

Weekly Timer Function

Easily set desired temperatures and operation ON/OFF times to match lifestyle patterns. Reduce wasted energy consumption by using the timer to prevent forgetting to turn off the unit and eliminate temperature setting adjustments.

Example Operation Pattern (Winter/Heating mode)

	Mon.	Tues.	Wed.	Thurs.	Fri.	Sat.	Sun.
6:00	ON 20°C	ON 20°C	ON 20°C	ON 20°C	ON 20°C	ON 20°C	ON 20°C
8:00	Automatically changes to high-power operation at wake-up time						
10:00	OFF	OFF	OFF	OFF	OFF	ON 18°C	ON 18°C
12:00	Automatically turned off during work hours					Midday is warmer, so the temperature is set lower	
14:00							
16:00							
18:00	ON 22°C	ON 22°C	ON 22°C	ON 22°C	ON 22°C	ON 22°C	ON 22°C
20:00	Automatically turns on, synchronized with arrival at home					Automatically raises temperature setting to match time when outside-air temperature is low	
22:00							
(during sleeping hours)	ON 18°C	ON 18°C	ON 18°C	ON 18°C	ON 18°C	ON 18°C	ON 18°C
	Automatically lowers temperature at bedtime for energy-saving operation at night						

Settings

Pattern Settings: Input up to four settings for each day

Settings: • Start/Stop operation • Temperature setting]The operation mode cannot be set.

Easy set-up using dedicated buttons



The remote controller is equipped with buttons that are used exclusively for setting the Weekly Timer. Setting operation patterns is easy and quick.

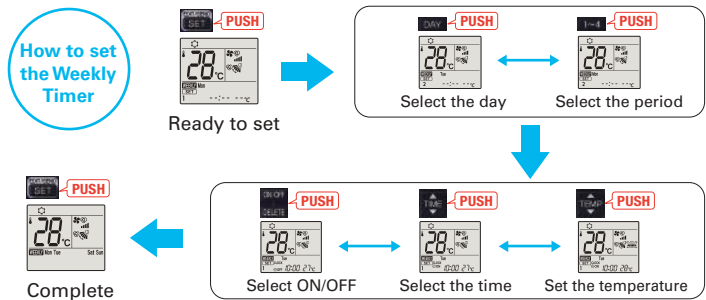

- Start by pushing the "SET" button and follow the instructions to set the desired patterns. Once all of the desired patterns are input, point the top end of the remote controller at the indoor unit and push the "SET" button one more time. (Push the "SET" button only after inputting all of the desired patterns into the remote controller memory. Pushing the "CANCEL" button will end the set-up process without sending the operation patterns to the indoor unit).
- It takes a few seconds to transmit the Weekly Timer operation patterns to the indoor unit. Please continue to point the remote controller at the indoor unit until all data has been sent.

Back Light Remote Controller

Not only the indoor units, but the wireless remote controllers come in four colours as well. Each remote controller matches the indoor unit. Even the textures are the same.

The setting can be easily checked in the dark.



INSTALLATION & MAINTENANCE

INSTALLATION



Cleaning-free Pipe Reuse

It is possible to reuse the same piping. It allows cleaning-free renewal of air conditioning systems that use R22 or R410 refrigerant.



Reuse of Existing Wiring

Wiring recycling problem solved! Compatible with other wiring connection methods*

The wiring method has been improved, making it possible to use methods different from that utilized for control and power supply. Units are compatible with the dual harness control line/power line method and the separate power supply method. Using a power supply terminal kit, wire can be efficiently reused at the time of system renewal regardless of the method the existing system uses.

* Optional. Usage may be limited due to wiring type diameter.

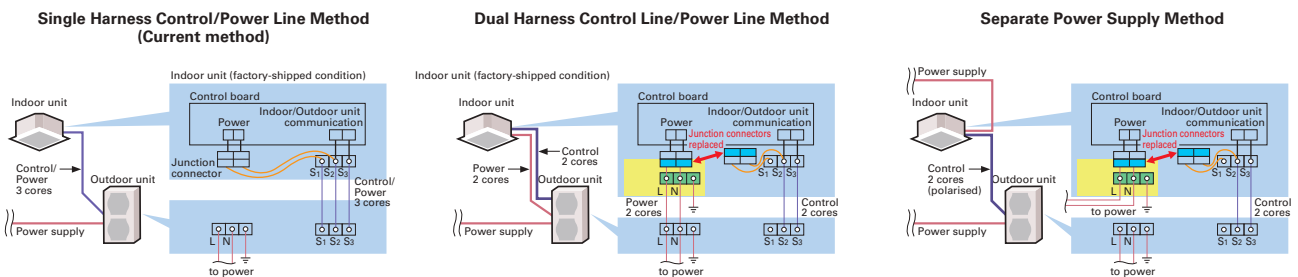

Wiring/Piping Correction Function*

The push of a single button is all that is required to confirm that piping and wiring are properly connected. Corrections are made automatically if a wiring error is detected, eliminating the need for complicated wiring confirmation work when expanding the number of rooms served.

* This function cannot be used when the outdoor temperature is below 0°C. The correction process requires 10–20 minutes, and only works when the unit is set to the Cooling mode.

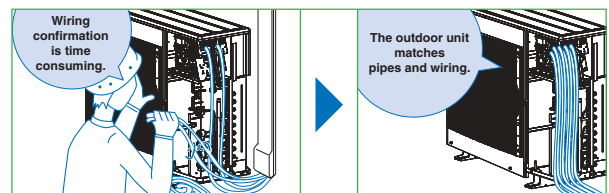

Drain Pump

A built-in drain pump enables drain piping to be raised.

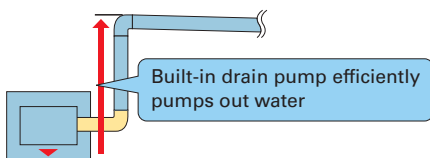

Flare Connection

Flare connection to cooling pipe work is possible.



Pump Down Switch

Enables smooth and easy recovery of refrigerant. Simply press the "Pump Down" switch before moving or changing the unit.

Outdoor unit control circuit board



* Photo of Model PUHZ-P100

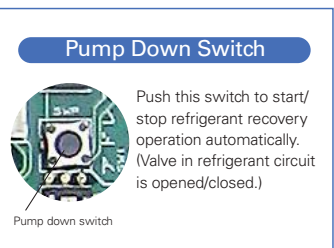

MAINTENANCE



Self-Diagnostic Function (Check Code Display)

Check codes are displayed on the remote controller or the operation indicator to inform the user of malfunctions detected.



Failure Recall Function

Operation failures are recorded, allowing confirmation when needed.

SYSTEM CONTROL

SYSTEM CONTROL

PAR-41MAA/PAC-YT52CRA/PAC-CT01MAA

Units are compatible for use with the PAR-41MAA, PAC-YT52CRA or PAC-CT01MAA remote controller, which has a variety of management functions.

System Group Control

The same remote controller is capable of controlling the operational status of up to 16 refrigerant systems.

M-NET Connection

Units can be connected to MELANS system controllers (M-NET controllers) such as the AG-150A.

MELCloud (Wi-Fi interface)

MELCloud for fast, easy remote control and monitoring

MELCloud is a Cloud-based solution for controlling air-conditioner either locally or remotely by computer, tablet or smartphone via the Internet. Setting up and remotely operating via MELCloud is simple and straight forward. All you need is wireless computer connectivity in your home or the building where the air-conditioner is installed and an Internet connection on your mobile or fixed terminal. To set up the system, the router and the Wi-Fi interface must be paired, and this is done simply and quickly using the WPS button found on all mainstream routers. You can control and check air-conditioner via MELCloud from virtually anywhere an Internet connection is available. That means, thanks to MELCloud, you can use much more easily and conveniently.

Key control and monitoring features

- 1 Turn system on/off
- 2 See status of operating & adjust set point
- 3 Live weather feed from your location
Schedule timer - Set 7 day weekly schedule
Error status
- 4 Energy Consumption Monitoring



MELCloud uses the MAC-587IF interface

Connecting the Wi-Fi interface

The new Wi-Fi interface MAC-567IF-E can be mounted on the wall or on the outer side of the indoor unit. For LN Series, there is a built-in Wi-Fi interface inside the indoor unit.

When mounting on the wall

The interface can be mounted simply by affixing the holder to the wall on either side of the unit and inserting the interface unit into the holder.



*When mounting on the right side of the unit

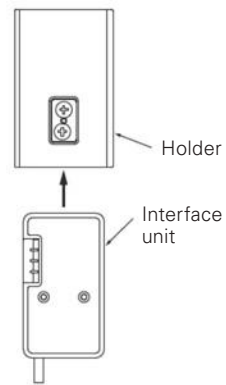

When mounting on the outer side of the unit

The interface can be mounted on the right side, left side, bottom right, or bottom left of the indoor unit. After inserting the clip into the holder, slip the clip over the edge of the corner box.

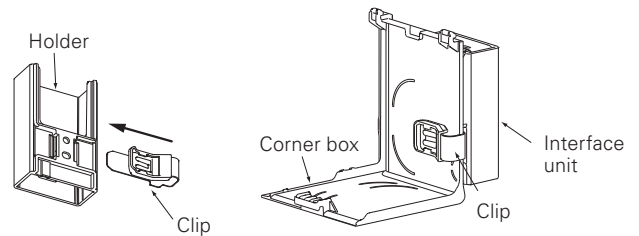

Right side



Bottom right



Left side



Bottom left

CONTROL TECHNOLOGIES

Extended cooling set temperature range*

In environments such as gyms where people do strenuous exercise, even if the room is cooled to an appropriate temperature, people may feel that it is hot, and they need a cooler air. To satisfy such demands, we have extended the lower limit of the cooling set temperature range from 19–30°C. to 14–30°C.

*Insulation kit (PAC-SK36HK-E) is required when indoor unit is PLA series.
*Availability of this function is depending on outdoor unit, indoor unit and remote controller.

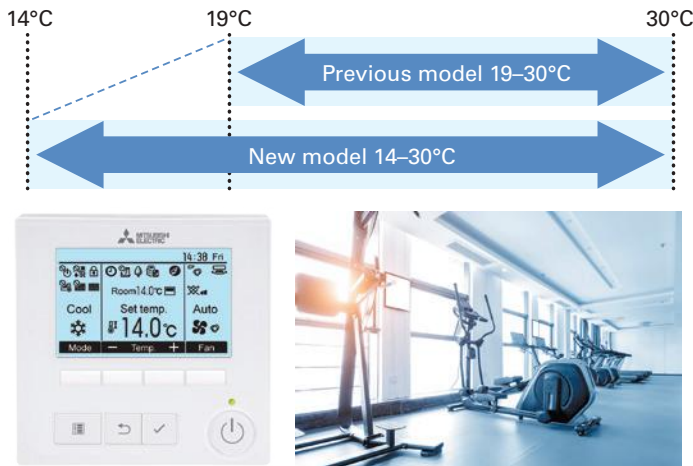

Display of model names and serial numbers*

The model names and serial numbers of the indoor/outdoor units that are connected to the MA smart remote controller can be automatically acquired and displayed through one simple operation. This eliminates the need to directly check each unit and helps with inquiries in the case of an abnormality.

*Availability of this function is depending on outdoor unit, indoor unit and remote controller.

- Model name display (example)

Collect model names and S/N	
0	OU PUZ-ZM200YKA2
IU1	PLA-ZM50EA2
IU2	PLA-ZM50EA2
IU3	PLA-ZM50EA2
IU4	PLA-ZM50EA2
Collect data: ✓	
- Address +	S/N
- Serial number display (example)

Collect model names and S/N	
0	IU 1ZU00001
IU1	1ZA00001
IU2	1ZA00002
IU3	1ZA00003
IU4	1ZA00004
Collect data: ✓	
- Address +	Model

Preliminary error history*

In addition to error history, the history of permissible abnormalities can be displayed. The feature enables the unit status check during inspection and maintenance.

*Availability of this function is depending on outdoor unit, indoor unit and remote controller.

● Error history (Sample)

Error	Unt#	dd/mm/yy
E0	0-1	21/10/20 PM12:34
E0	0-1	20/12/20 AM 1:23
E0	0-1	20/11/20 PM10:55
E0	0-1	20/10/20 PM12:01

Error history menu: [Refresh] [Page] [Delete]

● Preliminary error history (Sample)

Error	Unt#	dd/mm/yy
E0	0-1	21/10/20 PM12:34
E0	0-1	20/12/20 AM 1:23
E0	0-1	20/11/20 PM10:55
E0	0-1	20/10/20 PM12:01

Error history menu: [Refresh] [Page] [Delete]

Display of power consumption*

It is possible to measure, acquire, and display the amount of energy used by each air conditioning system.

*Availability of this function is depending on outdoor unit, indoor unit and remote controller.

< Data Collection Period >

Time data: Every 30 minutes over the past month

Monthly/daily data: Monthly over the past 14 months

Energy consumption values are calculated from estimated power consumption values according to the operating conditions. They may vary from the actual power consumption values. Please note that the power consumption of optional parts is not included except in the case of optional parts that have their power supplied directly by the outdoor unit.

● Every 30 minutes (example)

Energy data		
2019-1-1	1234.5kWh	1/6
0:30	123.4kWh	2:30 123.4kWh
1:00	123.4kWh	3:00 123.4kWh
1:30	123.4kWh	3:30 123.4kWh
2:00	123.4kWh	4:00 123.4kWh

Return: [Refresh] [Date] [Page]

● Daily (example)

Energy data		
2019-1	123456.7kWh	1/4
31	1234.5kWh	27 1234.5kWh
30	1234.5kWh	26 1234.5kWh
29	1234.5kWh	25 1234.5kWh
28	1234.5kWh	24 1234.5kWh

Return: [Refresh] [Page]

● Monthly (example)

Energy data		
▶2019-1	123456.7kWh	1/3
2018-12	123456.7kWh	
2018-11	123456.7kWh	
2018-10	123456.7kWh	
2018-9	123456.7kWh	

View daily data: [Check] [Cursor]

Horizontal airflow settings

The 4-way cassette model with 3D Total Flow system lets you easily set the horizontal airflow direction. This allows you to freely tailor the air conditioning performance according to your particular space and purpose.

*PLP-P160ELR-E is required to activate this function.

When 3D Total Flow is equipped

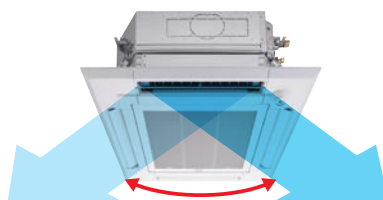

The horizontal airflow direction can be fixed for each outlet

Airflow direction set (Horiz)

4	2
3	

Default	Left
Centre-left	Front
Centre-right	Right

Select: [Check] [Outlet] [Angle]

Wi-Fi interface setting

When setting up a wireless LAN connection, it is now possible to switch between WPS and AP modes via the remote controller. You can configure a wireless network using the most convenient method according to the installation environment.

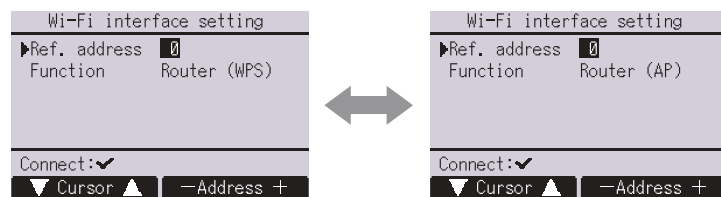

Easy To Read & Easy To Use

Inverted display screen

The screen background color can be set to black to suit the atmosphere of the installation location.



Full Dot Liquid-crystal Display Adopted

Easier to read thanks to use of a full dot liquid-crystal display with backlight, and easier to use owing to adopting a menu format that has reduced the number of operating buttons.

Display Example [Operation Mode]

Full Dot LCD



Multi-language Display

Multi-language

Control panel operation in fourteen different languages

Choose the desired language, among the following languages.



Temperature Control

Dual Set Point

Two preset temperatures

When the operation mode is set to the Auto (Dual Set Point) mode, two preset temperatures (one each for cooling and heating) can be set. Depending on the room temperature, indoor unit will automatically operate in either the COOL or HEAT mode and keep the room temperature within the preset range.



Operation pattern during Auto (Dual Set Point) mode

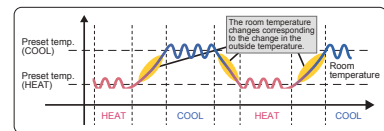

*Please refer to the function list on pages 193-200 for the combination of the available units.

Energy-efficient Control

Operation Control Functions

Energy-saving Schedule

Precise control of power consumption

The amount of power consumed in each time period is managed so that the demand value is not exceeded. The demand control function can be set to start and finish in 5-minute units. Additionally, the level can be adjusted to 0, 50, 60, 70, 80 or 90% of maximum capacity, and up to 4 patterns can be set per day. Air-conditioning operation is automatically controlled to ensure that electricity in excess of the contracted volume is not consumed.

Setting pattern example

Start time	Finish time	Capacity savings
8:15	→ 12:00	80%
12:00	→ 13:00	50%
13:00	→ 17:00	90%
17:00	→ 21:00	50%

Auto-return

Prevents wasteful operation by automatically returning to the preset temperature after specified operating time

After adjusting the temperature for initial heating in winter or cooling on a hot summer day, it is easy to forget to return the temperature setting to its original value. The Auto-return function automatically resets the temperature back to the original setting after a specified period of time, thereby preventing overheating/overcooling. The Auto-return activation time can be set in 10-minute units, in a range between 30 and 120 minutes.

*Auto-return cannot be used when Temperature Range Restrictions is in use.

Auto-off Timer

Turns heating/cooling off automatically after preset time elapses

When using Auto-off Timer, even if one forgets to turn off the unit, operation stops automatically after the preset time elapses, thereby preventing wasteful operation. Auto-off Timer can be set in 10-minute units, in a range between 30 minutes and 4 hours. Eliminates all anxiety about forgetting to turn off the unit.

Recommended for **Meeting room** **Changing room**

CONTROL TECHNOLOGIES

Night Setback

Keep desired room temperatures automatically

This function monitors the room temperature and automatically activates the heating mode when the temperature drops below the preset minimal temperature setting. It has the same function for cooling, automatically activating the cooling mode when the temperature rises above the preset maximum temperature setting.

Operation Lock

Fixed temperature setting promotes energy savings

In addition to operation start/stop, the operation mode, temperature setting and airflow direction can be locked. Unwanted adjustment of temperature settings is prevented and an appropriate temperature is constantly maintained, leading to energy savings. This feature is also useful in preventing erroneous operation or tampering.

Recommended for **Office** **School** **Public hall**
Hospital **Computer server facility**

Temperature Range Restriction

Temperature Range Restriction prevents overheating/overcooling

Using a temperature that is 1°C lower/higher for heating/cooling results in a 10% reduction in power consumption.* Temperature Range Restriction limits the maximum and minimum temperature settings, contributing to the prevention of overheating/overcooling.

*In-house calculations

Cooling/Dry

(Setting example of minimum temp. in 25°C)

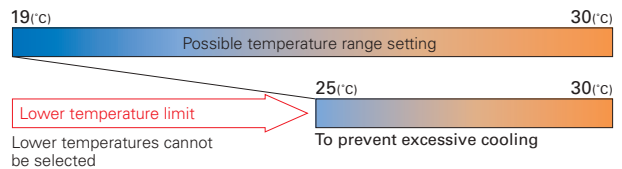

Recommended for **Office** **Restaurant**

Weekly Timer

Weekly Timer with Two Types of Settings

Weekly schedule timer can save two different settings which can be easily switched according to different seasons. In addition, it offers eight different pattern setting per day. (on, off and temperature setting)

*Weekly Timer cannot be used when On/Off Timer is in use.

Setting Example (restaurant in summer time)

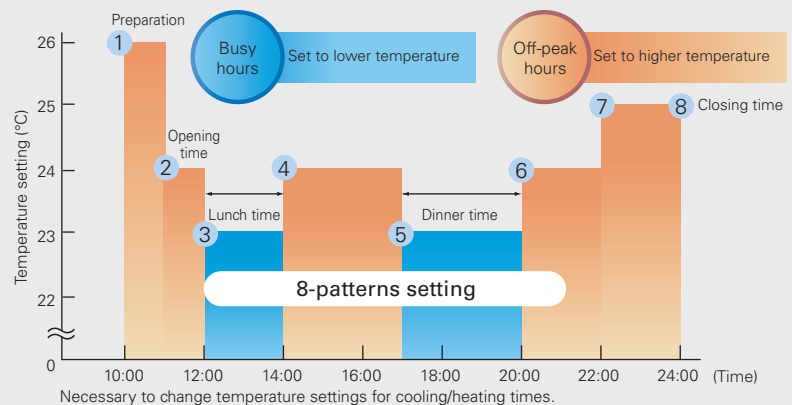

Necessary to change temperature settings for cooling/heating times.

*Joint research conducted with Japan Facility Solutions, Inc.

Installation/Maintenance Support Functions

Smooth Maintenance

Outdoor unit data accessed immediately, enabling fast maintenance (only PUZ/PUHZ type)

Using the Stable Operation Control (fixed frequency) of the Smooth Maintenance function, the operating status of the inverter can be checked easily via the screen on the remote controller.

Smooth Maintenance Function Operating Procedure

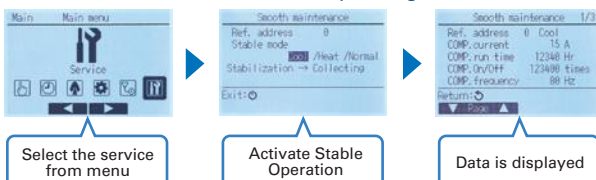

Display information (11 items)

Compressor		
⑥	OU TH4 temp. (°C)	
①	COMP. current (A)	⑦
②	COMP run time (Hr)	⑧
③	COMP. ON/OFF (times)	⑨
④	COMP. frequency (Hz)	⑩
Indoor Unit		
⑤	Sub cool (°C)	⑪
Outdoor Unit		
	IU air temp. (°C)	
	IU HEX temp. (°C)	
	IU filter operating time* (Hr)	

*IU filter operating time is the time elapsed since filter was reset.

Inspection Guidelines

The computed temperature difference is plotted as in the graph below and operating status is determined.

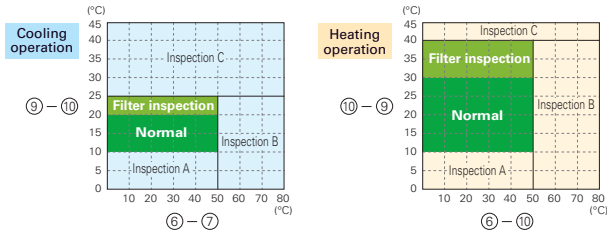

Result

		Item
Cooling	Temp. difference	(⑥ OU TH4 temp.) - (⑦ OU TH6 temp.)
Heating		(⑨ IU air temp.) - (⑩ IU HEX temp.)
		(⑥ OU TH4 temp.) - (⑩ IU HEX temp.)
		(⑩ IU HEX temp.) - (⑨ IU air temp.)

Normal	Normal operating status.
Filter inspection	Filter may be blocked.*1
Inspection A	Capacity is reduced. Detailed inspection is necessary.
Inspection B	Refrigerant level is low.
Inspection C	Filter or indoor unit heat exchanger is blocked.

*1: Due to indoor and outdoor temperatures, "Filter inspection" may be displayed even if the filter is not blocked.

* The above graphs are based on trial data. Results may vary depending on installation/temperature conditions.

- Stable operation may not be possible under the following temperature conditions: a) In cooling mode when the outdoor induction temperature is over 40°C or the indoor induction temperature is below 23°C. b) In heating mode when the outdoor induction temperature is over 20°C or when the indoor induction temperature is over 25°C.
- If the above temperature conditions do not apply and stable operation is not achieved after 30 minutes has passed, please inspect the units.
- The operating status may change due to frost on the outdoor heat exchanger.

Manual Vane Angle Setting (4-way ceiling cassette)

Direction of vertical airflow for each vane can be set

Setting the vertical airflow direction for each individual vane can be performed simply via illustrated display. Seasonal settings such as switching between cooling and heating are easily changed as well.

Auto-descending Panel Operation

Easily raise/lower panels using the remote controller

Auto-descending panel operation is available as an option. Panels can be raise/lower using a button on the wired remote controller. Filter cleaning can be performed easily.

Silent Mode

Three outdoor noise level setting

The outdoor noise level can be reduced on demand according to the surrounding environment. Select from three setting mode: standard mode (rated), silent mode and ultra-silent mode.

Initial Password Setting

Password for initial settings

A password is required (default setting is "0000") for initial settings such as time and display language.

Simple MA Remote Controller PAC-YT52CRA

Backlit LCD

Features a liquid-crystal display (LCD) with backlight for operation in dark conditions.

Flat Back

The slim and flat-back shape makes installation easier without requiring a hole in the wall. Thickness is 14.5mm or less.

Vane Angle Setting

The vane button has been added to allow users to change the airflow direction (ceiling-cassette and wall-mounted units).

Pressing the  button will switch the vane direction.

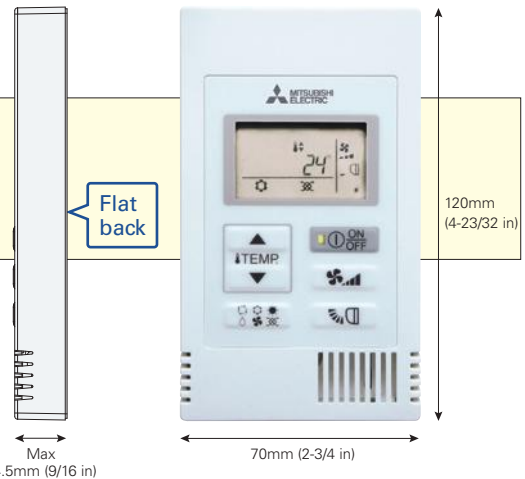
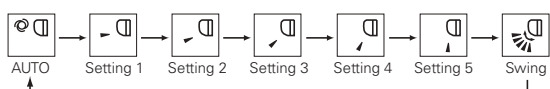

Dual Set Point

Two preset temperatures

When the operation mode is set to the Auto (Dual Set Point) mode, two preset temperatures (one each for cooling and heating) can be set. Depending on the room temperature, indoor unit will automatically operate in either the COOL or HEAT mode and keep the room temperature within the preset range.

Operation pattern during Auto (Dual Set Point) mode

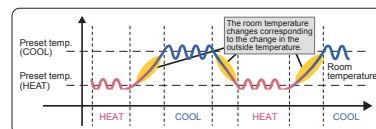

*Please refer to the function list on pages 193-200 for the combination of the available units.

* The settable vane directions vary depending on the indoor unit model to be connected.

* If the unit has no vane function, the vane direction cannot be set. In this case, the vane icon flashes when the  button is pressed.

CONTROL TECHNOLOGIES

MA Touch Remote Controller
PAR-CT01MAA-SB
PAR-CT01MAA-PB



PAC-CT01MAA-SB



PAR-CT01MAA-PB

User-friendly Visible big size icons on the full color touch panel display

Full color touch panel display



Touch Panel

3.5 inch/HVGA Full Color LCD



Operation panels



Temperature setting



Operation mode



Fan speed



Vane control



Ventilation



Louver control

Flexibility Customized display, color on parameter and background, editable parameter, logo image on the initial display

Multiple color pattern

180 color patterns can be selected for control parameters or background on the display.

Control parameter customize

Users can customize the panel to display the selected parameters only.

● Control parameter customize

Simple operation panel is preferred by users, especially in hotels. It is available to display only ON/OFF, set temp., fan speed.



Logo image customization

Logo image can be displayed on the initial screen.



160 pixels

320 pixels

Available in a wide variety of colors to suit the decor of any room.



Expandability Smartphone / tablet App is available for setting, customize, and control.

Bluetooth® low energy technology

Remote controller can communicate with smartphone or tablet device via Bluetooth Low Energy (BLE). Operation & Setting App are available on the App store.



*The Bluetooth® word mark is trademark of Bluetooth SIG, Inc., USA.
*Contact the sales company for information on "Bluetooth" function.

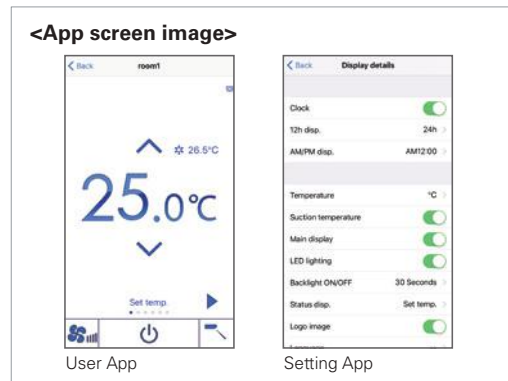

Convenient BLE transmission functions for installation contractors

Initial setup for the remote controller can be easily performed using BLE transmission via a smartphone.

● Previous model

Previously, initial setup (selecting function parameters) was only available via the remote controller installed each room.

● New model

The initial setup (selecting function parameters) can now be performed in advance on a smartphone, with the settings transmitted to the remote controller by enabling BLE transmission upon entry to the room.

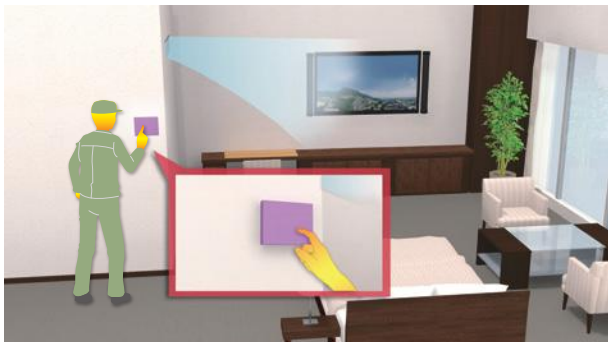

Convenient BLE transmission functions for guests

The remote controller has been further upgraded with hotels in mind, to allow smartphone connectivity and multilingual support.

Smartphone connectivity

For example, hotel guests can operate the air conditioner via their smartphones, without getting out of bed.

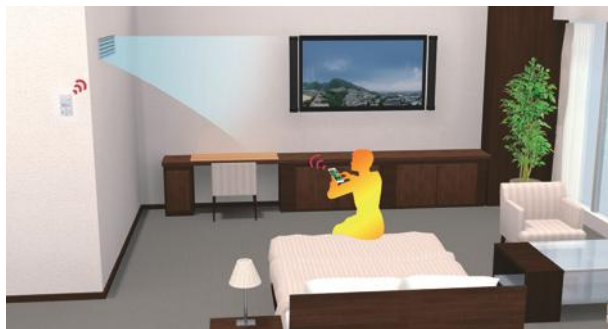

Multilingual support

The smartphone app can be displayed in the language that the guest's smartphone is set to.



CONTROL TECHNOLOGIES

Wireless Remote Controller PAR-SL101A-E

Extended cooling set temperature range*

In environments such as gyms where people do strenuous exercise, even if the room is cooled to an appropriate temperature, people may feel that it is hot, and they need a cooler air. To satisfy such demands, we have extended the lower limit of the cooling set temperature range from 19–30°C. to 14–30°C.



*Insulation kit (PAC-SK36HK-E) is required when indoor unit is PLA series.
*Availability of this function is depending on outdoor unit, indoor unit and remote controller.

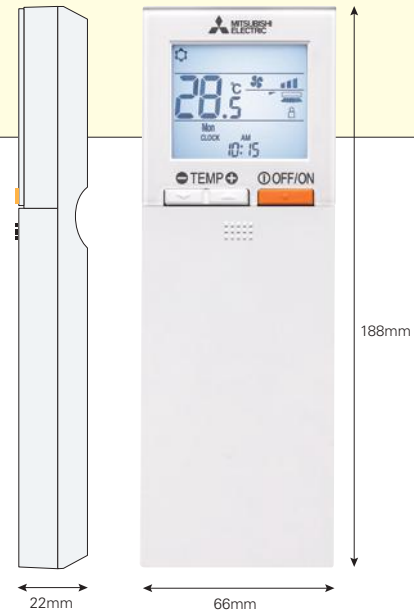
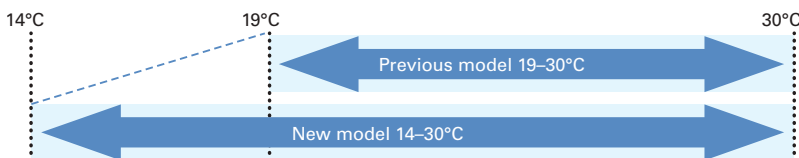

Horizontal airflow settings

The 4-way cassette model complete with the Smart 360-degree Airflow system lets you easily set the horizontal airflow direction. This allows you to freely tailor the air conditioning performance according to your particular space and purpose.

Front	Centre-right	Right	Centre-left	Left	No setting

[Setting the horizontal airflow function]

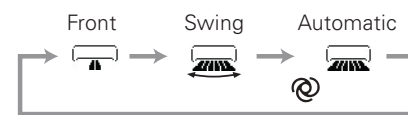

Weekly Timer

The Weekly Timer enables the setting of operation start and finish times and adjusting the temperature as standard features. Up to 4 patterns per day can be set, providing operation that matches the varying conditions of each period, such as the number of customers in the store.

Example Operation Pattern (Winter/Heating mode)

	Mon.	Tues.	Wed.	Thurs.	Fri.	Sat.	Sun.
6:00	ON 20°C	ON 20°C	ON 20°C	ON 20°C	ON 20°C	ON 20°C	ON 20°C
8:00	Automatically changes to high-power operation at wake-up time						
12:00	OFF	OFF	OFF	OFF	OFF	ON 18°C	ON 18°C
14:00	Automatically turned off during work hours						
16:00	Midday is warmer, so the temperature is set lower						
18:00	ON 20°C	ON 20°C	ON 20°C	ON 20°C	ON 20°C	ON 20°C	ON 20°C
20:00	Automatically turns on, synchronized with arrival at home						
22:00 (during sleeping hours)	ON 18°C	ON 18°C	ON 18°C	ON 18°C	ON 18°C	ON 18°C	ON 18°C
	Automatically lowers temperature at bedtime for energy-saving operation at night						

*Weekly Timer cannot be used when On/Off Timer is in use.

*Only for SLZ-KF25/35/50/60VA2, PLA-ZP/35/50/60/71/100/125/140EA

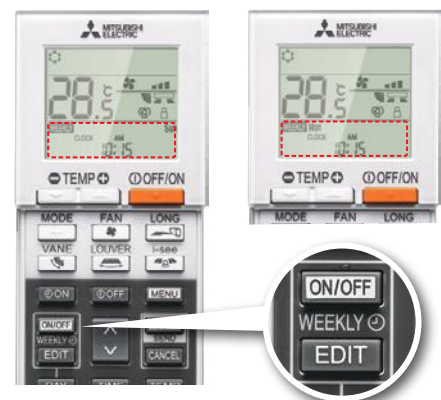

Backlight

Backlight function incorporated, making screen easy to read in the dark. Even in dimly lit rooms, the screen can be seen clearly for trouble-free remote controller operation.



Individual Vane Settings

The airflow directions of the four vanes can each be adjusted independently. Easily set the optimum airflow according to the room setting.

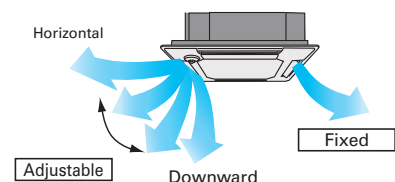
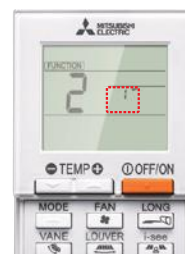

Battery Replacement Sign

Previous wireless remote controllers were not easy to read, understand or use sometimes because the battery was low. Beginning with the PAR-SL101A-E, a battery charge indicator that shows the charge status is included in the LCD so it can be seen when the battery is low and needs to be changed.



Dual Set Point

When the operation mode is set to the Auto (Dual Set Point) mode, two preset temperatures (one each for cooling and heating) can be set. Depending on the room temperature, the indoor unit will automatically operate in either the COOL or HEAT mode and keep the room temperature within the preset range.

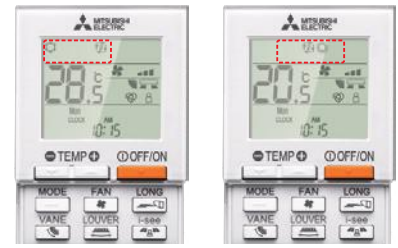

Operation pattern during Auto (Dual Set Point) mode

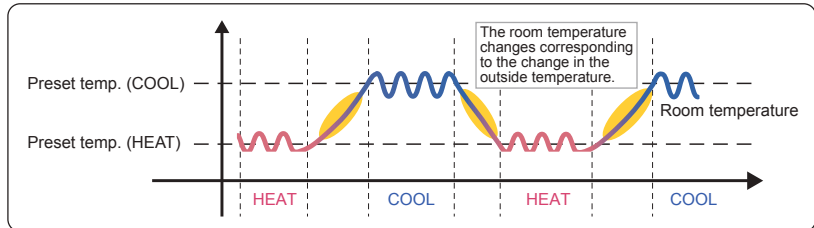

* Only available for compatible models.

3D i-see Sensor (Direct/Indirect Airflow)

Pressing the i-see button enables direct or indirect setting of all vanes.

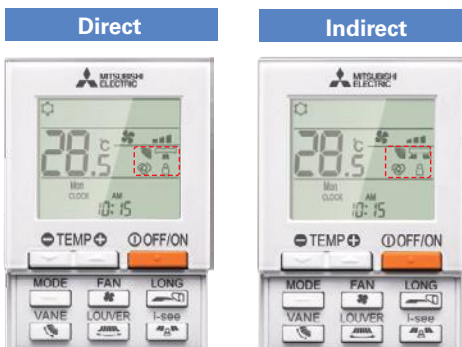

	Vane setting	
	Direct	Indirect
Cooling	horizontal → swing	keep horizontal
Heating	keep downward	downward → horizontal

Direct Airflow

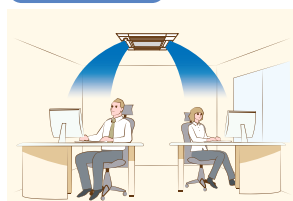

Indirect Airflow

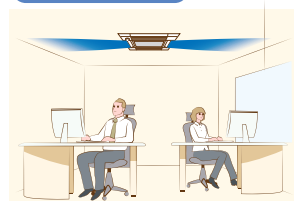

* Only available for models equipped with 3D i-see Sensor.

Basic Functions

Functions	Button	Liquid crystal
OFF / ON	⏻ OFF/ON	
Preset temperature	⊖ TEMP ⊕	88.5 °C
Mode	MODE	Cool Dry Heat Fan Auto Dual set point *Dual Set Point function not operational first use.
Fan speed	FAN	4-Speed Auto
Vane angle	VANE	5-step Swing Auto
Louver	WIDE VANE	Fixed Swing
3D i-see Sensor	i-see	Direct Indirect
Send sign		
Battery replacement sign		
Function setting		FUNCTION
Test run		TEST
Self check		CHECK
Not available		N/A





*This remote controller is only compatible with the following models: SLZ-M15/25/35/50/60FA, PLFY-P15/20/25/32/40/50VFM-E1, PLA-ZM/RP35/50/60/71/100/125/140EA, PLFY-P20/25/32/40/50/63/80/100/125VEM-E

*Functions available vary according to the model.

SYSTEM CONTROL

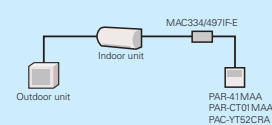
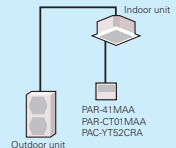
Versatile system controls can be realised using optional parts, relay circuits, control panels, etc.

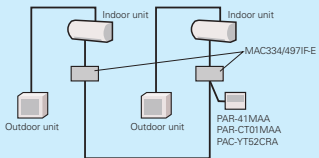
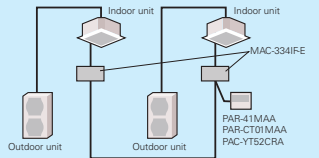
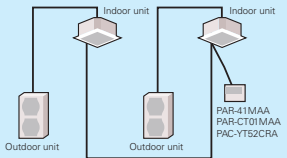
MAJOR SYSTEM CONTROL

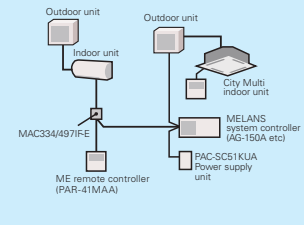
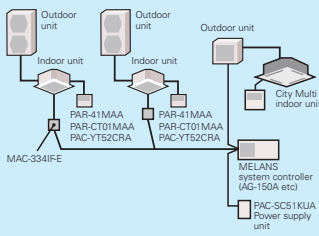
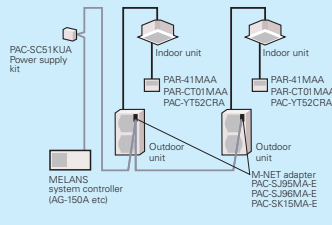
System Examples			
Indoor Unit	M Series Indoor Unit	S Series & P Series Indoor Unit	S Series & P Series
Outdoor Unit	M Series and MXZ Series Outdoor	S Series and MXZ Series Outdoor	P Series Outdoor
 <p>PAR-41MAA Control PAC-YT52CRA Control</p>			
Details	<ul style="list-style-type: none"> Wired remote controller can be connected to indoor unit 	Standard equipment (for indoor units compatible with wired remote controllers)	
Major Optional Parts Required	<ul style="list-style-type: none"> MAC334/497IF-E (Interface) PAR-41MAA (Wired remote controller) PAR-CT01MAA (Wired remote controller) PAC-YT52CRA (Wired remote controller) 	<ul style="list-style-type: none"> PAR-41MAA (Wired remote controller) PAR-CT01MAA (Wired remote controller) PAC-YT52CRA (Wired remote controller) 	
 <p>System Group Control</p>			
Details	<ul style="list-style-type: none"> One remote controller can control plural air conditioners with the same settings simultaneously. One remote controller can control up to 16 refrigerant systems. (When connected to a MXZ unit, MAC-334IF-E is counted as one system.) Up to two remote controller can be connected. PAR-SL101A cannot be used when connected through the MAC-334IF-E or when group control is used. 		
Major Optional Parts Required	<ul style="list-style-type: none"> MAC334/497IF-E (Interface) PAR-41MAA (Wired remote controller) PAR-CT01MAA (Wired remote controller) PAC-YT52CRA (Wired remote controller) 		<ul style="list-style-type: none"> PAR-41MAA (Wired remote controller) PAR-CT01MAA (Wired remote controller) PAC-YT52CRA (Wired remote controller)
 <p>M-NET Connections</p>			
Details	<ul style="list-style-type: none"> Group of air conditioners can be controlled by MELANS system controller (M-NET). 		
Major Optional Parts Required	<ul style="list-style-type: none"> MAC334/497IF-E (M-NET Interface) MELANS System controller PAC-SC51KUA (power supply unit) 		<ul style="list-style-type: none"> PAC-SJ95MA-E or PAC-SJ96MA-E (M-NET converter) MELANS System controller PAC-SC51KUA (power supply unit)

OTHERS

For M Series Indoor Units (New A-control Models Only)

	System Examples	Connection Details	Control Details	Major Optional Parts Required
1 Remote On/Off Operation • Air conditioner can be started/stopped remotely. (1) and (2) can be used in combination	<p style="font-size: small;">Outdoor unit Indoor unit MAC-334IFE Remote control section (to be purchased locally)</p>	Connect the interface to the air conditioner. Then connect the locally purchased remote controller to the terminal in the interface.	On/Off operation is possible from a remote location.	<ul style="list-style-type: none"> MAC-334IFE (Interface) Parts for circuit such as relay box, lead wire, etc. (to be purchased locally)
2 Remote Display of Operation Status • The On/Off status of air conditioners can be confirmed remotely. (1) and (2) can be used in combination	<p style="font-size: small;">Outdoor unit Indoor unit MAC-334IFE Remote monitor section (to be purchased locally) Power supply Resistance LED</p>	Connect the interface to the air conditioner. Then connect the locally purchased remote controller to the terminal in the interface.	The operation status (On/Off) or error signals can be monitored from a remote location.	<ul style="list-style-type: none"> MAC-334IFE (Interface) Parts for circuit to be purchased locally (DC power source needed) External power source (12V DC) is required when using MAC-334IFE.

For P Series and S Series Indoor Units

	System Examples		Details	Major Optional Parts Required
	Wired remote controller	Wireless remote controller		
A 2-remote Controller Control With two remote controllers, control can be performed locally and remotely from two locations.	<p style="font-size: small;">PAR-41MAA PAC-YT52CRA</p> <p style="font-size: x-small;">* Set "Main" and "Sub" remote controllers.</p> <p style="font-size: x-small;">(Example of 1 : 1 system)</p>	<p style="font-size: small;">PAR-SL97/101A-E PAR-41MAA PAC-YT52CRA</p> <p style="font-size: x-small;">* When using wired and wireless remote controllers</p> <p style="font-size: x-small;">(Example of Simultaneous Twin)</p>	<ul style="list-style-type: none"> Up to two remote controllers can be connected to one group. Both wired and wireless remote controllers can be used in combination. 	<ul style="list-style-type: none"> Wired Remote Controller PAR-41MAA PAC-YT52CRA (for PKA, PAC-SH29TC-E is required) Wireless Remote Controller PAR-SL97A-E / PAR-SL101A-E (only for SLZ) Wireless Remote Controller Kit for PCA PAR-SL94B-E
B Operation Control by Level Signal Air conditioner can be started/stopped remotely. In addition, On/Off operation by local remote controller can be prohibited/permitted.	<p style="font-size: x-small;">Relay box (to be purchased locally)</p> <p style="font-size: x-small;">Remote control panel Adapter for remote On/Off Wired remote controller</p> <p style="font-size: x-small;">(Example of 1 : 1 system x 2)</p>	<p style="font-size: x-small;">Relay box (to be purchased locally)</p> <p style="font-size: x-small;">Remote control panel Adapter for remote On/Off PAR-SL97/101A-E</p> <p style="font-size: x-small;">(Example of 1 : 1 system x 2)</p>	<ul style="list-style-type: none"> Operation other than On/Off (e.g., adjustment of temperature, fan speed, and airflow) can be performed even when remote controller operation is prohibited. Timer control is possible with an external timer. 	<ul style="list-style-type: none"> Adapter for remote On/Off PAC-SE55RA-E Relay box (to be purchased locally) Remote control panel (to be purchased locally)
C Operation Control by Pulse Signal	<p style="font-size: x-small;">Relay box (to be purchased locally)</p> <p style="font-size: x-small;">Remote control panel Connector cable for remote display Wired remote controller</p> <p style="font-size: x-small;">(Example of 1 : 1 system x 2)</p>	<p style="font-size: x-small;">Relay box (to be purchased locally)</p> <p style="font-size: x-small;">Remote control panel Connector cable for remote display PAR-SL97/101A-E</p> <p style="font-size: x-small;">(Example of 1 : 1 system x 2)</p>	<ul style="list-style-type: none"> The pulse signal can be turned On/Off. Operation/emergency signal can be received at a remote location. 	<ul style="list-style-type: none"> Connector cable for remote display PAC-SA88HA-E / PAC-725AD (10 pcs. x PAC-SA88HA-E) Relay box (to be purchased locally) Remote control panel (to be purchased locally)
D Remote Display of Operating Status Operating status can be displayed at a remote location.	<p style="font-size: x-small;">Remote operation adapter/ Connector cable for remote display + Relay box</p> <p style="font-size: x-small;">Remote display panel Adapter for remote display PAR-41MAA / PAR-CT01MAA / PAC-YT52CRA</p> <p style="font-size: x-small;">(Example of 1 : 1 system)</p>	<p style="font-size: x-small;">Remote operation adapter/ Connector cable for remote display + Relay box</p> <p style="font-size: x-small;">Remote display panel Adapter for remote display PAR-SL97/101A-E</p> <p style="font-size: x-small;">(Example of Simultaneous Twin)</p>	<ul style="list-style-type: none"> Operation/emergency signal can be received at a remote location (when channeled through the PAC-SF40RM-E → no-voltage signal, when channeled through the PAC-SA88HA-E → DC 12V signal). 	<ul style="list-style-type: none"> Remote display panel (to be purchased locally) Connector cable for remote display PAC-SA88HA-E / PAC-725AD (10 pcs. x PAC-SA88HA-E) Relay box (to be purchased locally) Remote operation adapter PAC-SF40RM-E <p style="font-size: x-small;">* Unable to use with wireless remote controller</p>
E Timer Operation Allows On/Off operation with timer *For control by an external timer, refer to (B) Operation Control by Level Signal.	<p style="font-size: small;">PAR-41MAA / PAR-CT01MAA</p> <p style="font-size: x-small;">(Example of 1 : 1 system)</p>		<ul style="list-style-type: none"> Weekly Timer: On/Off and up to 8 pattern temperatures can be set for each calendar day. (Initial setting) On/Off Timer: On/Off can be set once each within 72 hr in intervals of 5-minute units. Auto-off Timer: Operation will be switched off after a certain time elapse. Set time can be changed from 30 min. to 4 hr. at 10 min. intervals. <p style="font-size: x-small;">*Simple Timer and Auto-off Timer cannot be used at the same time.</p>	Standard functions of PAR-41MAA / PAR-CT01MAA

FUNCTION LIST (1)

Category	Icon	M SERIES										
		Combination	Indoor unit	MSZ-RW25/35/50VG	MSZ-LN18/25/35/50/60VG2(W)(V)(R)(B)	MSZ-FT25/35/50VG	MSZ-AY25/35/42/50VGK(P)	MSZ-AP15/20VG	MSZ-AP60/71VG	MSZ-EF18/22/25/35/42/50VG(W)(B)(S)	MSZ-BT20/25/35/50VG	MSZ-HR25/35/42/50/60/71VF
			Outdoor unit	MUZ-RW	MUZ-LN	MUZ-FT	MUZ-AY	MUZ-AP		MUZ-EF	MUZ-BT	MUZ-HR
Technology		DC Inverter	●	●	●	●	●	●	●	●	●	
		Joint Lap DC Motor	●	●	●	●	●	●	●	●	●	
		Reluctance DC Rotary Compressor										
		Heating Caulking (Compressor)	●	●	●	●	●	●	●	●	●	
		DC Fan Motor	●	●	●	●	●	●	●	●	●	
		PAM (Pulse Amplitude Modulation)	●	●	●	●	●	●	●	●	●	
		Power Receiver and Twin LEV Control										
		Grooved Piping	●	●	●	●	●	●	●	●	●	
Functions	i-see Sensor	Felt Temperature Control (3D i-see Sensor)	●	●								
		AREA Temperature Monitor	●	●								
	Energy Saving	Econo Cool Energy-saving Feature	●	●	●	●	●	●	●	●	●	
		Standby Power Consumption Cut	●	●	●	●	●	●	●	●	●	
	Air Quality	Plasma Quad Plus	●	●		● ^{*1}						
		Plasma Quad										
		Dual Barrier Coating	●	●								
		Dual Barrier Material	●									
		Silver-ionized Air Purifier Filter		Opt	●	Opt		Opt	●	Opt	Opt	
		V Blocking Filter	Opt	Opt	●	● ^{*2}	●	●	●	●	●	Opt
		Air Purifying Filter			●	●	●	●	●	●	●	
	Self Clean Mode				●							
	Air Distribution	Double Vane	●	●								
		Horizontal Vane	●	●	●	●	●	●	●	●	●	
		Vertical Vane	●	●	●	●	●	●				
		High Ceiling Mode										
		Auto Fan Speed Mode	●	●	●	●	●	●	●	●	●	
	Circulator Mode	● ^{*3}	● ^{*3}	● ^{*3}	● ^{*3}							
	Convenience	On/off Operation Timer	●	●	●	●	●	●	●	●	●	
		"i save" Mode	●	●	●	●	●	●	●	●	●	
		Auto Changeover	●	●	●	●	●	●	●	●	●	
		Auto Restart	●	●	●	●	●	●	●	●	●	
		Low-temperature Cooling	●	●	●	●	●	●	●	●	●	
		10°C Heating	●	●	●	●	●	●		●		
		Low-noise Operation (Outdoor Unit)										
		Night Mode	●	●	●	●	●	●		●		
Ampere Limit Adjustment												
Operation Lock (Indoor)		●	●	●	●	●	●		●			
Operation Lock (Outdoor)												
Built-in Weekly Timer Function		●	●	●	●	●	●	●				
Drive Mode Selector												
System Control	PAR-41MAA Control *5	Opt	Opt	Opt	Opt	Opt	Opt	Opt	Opt	Opt		
	PAR-CT01MAA Control *5	Opt	Opt	Opt	Opt	Opt	Opt	Opt	Opt	Opt		
	PAC-YT52CRA Control *5	Opt	Opt	Opt	Opt	Opt	Opt	Opt	Opt	Opt		
	Centralised On/Off Control *5	Opt	Opt	Opt	Opt	Opt	Opt	Opt	Opt	Opt		
	System Group Control *5	Opt	Opt	Opt	Opt	Opt	Opt	Opt	Opt	Opt		
	M-NET Connection *5	Opt	Opt	Opt	Opt	Opt	Opt	Opt	Opt	Opt		
	Wi-Fi Interface	●	●	● ^{*6}	●	● ^{*6}	● ^{*6}	● ^{*6}	● ^{*6}	● ^{*6}	● ^{*6}	
	Energy Consumption Monitoring through MEL Cloud											
Installation	Cleaning-free Pipe Reuse	●	●	●	●	●	●	●	●	●		
	Wiring/Piping Correction Function											
	Drain Pump											
	Flare Connection	●	●	●	●	●	●	●	●	●		
Maintenance	Self-Diagnosis Function (Check Code Display)	●	●	●	●	●	●	●	●	●		
	Failure Recall Function	●	●	●	●	●	●	●	●	●		

*1 Only VGKP model.

*2 Equipped as standard for VGK model.

*3 Available only for Scandinavian model.

*4 When multiple indoor units connected to an MXZ outdoor unit are running at the same time, simultaneous cooling and heating is not possible.

*5 Please refer to "System Control" on pages for details.

*6 Only VGK model.

FUNCTION LIST (2)

Category	Icon	S SERIES									
		Combination	Indoor unit	SLZ-M15/25/35/50/60FA2 *1				SEZ-M25/35/50/60/71DA(L)2			SFZ-M25/35/50/60/71VA
			Outdoor unit	SUZ-M	SUZ-KA	PUZ-ZM	PUHZ-ZRP	SUZ-M	SUZ-KA	PUZ-ZM	SUZ-M
Function merit-up	3D Total Flow										
	2+1 Back-up rotation			●					●		
	Extended cooling set temperature range										
	Display of model names and serial numbers			●					●		
	Display of power consumption	●		●		●		●	●		
	Avoiding simultaneous defrosting			●					●		
	Defrosting when people are absent			●							
	Defrosting when operation is stopped			●					●		
	Collection of operation data via MELCloud			●					●		
	Demand control via MELCloud			●					●		
Notification of potential abnormality via MELCloud			●					●			
Technology	DC Inverter		●	●	●	●	●	●	●	●	
	Joint Lap DC Motor		●	●			●	●		●	
	Magnetic Flux Vector Sine Wave Drive			●	●						
	Reluctance DC Rotary Compressor	●	●				●	●		●	
	Highly Efficient DC Scroll Compressor			●	●						
	Heating Caulking (Compressor)	●	●				●	●		●	
	DC Fan Motor	●	●	●	●	●	●	●		●	
	Vector-Wave Eco Inverter			●	●						
	PAM (Pulse Amplitude Modulation)	●	●	●	●	●	●	●		●	
	Power Receiver and Twin LEV Control			●	●						
Grooved Piping	●	●	●	●	●	●	●		●		
i-see Sensor	Felt Temperature Control (3D i-see Sensor)		Opt	Opt	Opt	Opt					
	AREA Temperature Monitor		Opt	Opt	Opt	Opt					
Energy Saving	Demand Function										
Attractive	Pure White	●	●	●	●						
	Auto Vane	●	●	●	●						
Air Quality	Fresh-air Intake	●	●	●	●						
	High-efficiency Filter										
	Oil Mist Filter										
	Long-life Filter	●	●	●	●						
	Filter Check Signal	●	●	●	●						
Air Distribution	Horizontal Vane	●	●	●	●						
	Vertical Vane										
	High Ceiling Mode	●	●	●	●						
	Low Ceiling Mode										
Convenience	Auto Fan Speed Mode	●	●	●	●	●	●			●	
	On/off Operation Timer	●	●	●	●	●	●			●	
	Auto Changeover	●	●	●	●	●	●			●	
	Auto Restart	●	●	●	●	●	●			●	
	Low-temperature Cooling	●	●	●	●	●	●			●	
	Low-noise Operation (Outdoor Unit)			●	●						
	Ampere Limit Adjustment				60-140V	60-140V					
	Operation Lock										
Rotation, Back-up and 2nd Stage Cut-in Functions			●	●							
Dual Set Point *2			●	●							
System Control	PAR-41MAA Control *3		Opt	Opt	Opt	Opt	Opt			Opt	
	PAR-CT01MAA Control *3		Opt	Opt	Opt	Opt	Opt			Opt	
	PAC-YT52CRA Control *3		Opt	Opt	Opt	Opt	Opt			Opt	
	Centralised On/Off Control *3		Opt	Opt	Opt	Opt	Opt			Opt	
	System Group Control *3		Opt	Opt	Opt	Opt	Opt			Opt	
	M-NET Connection *3		Opt	Opt			Opt			Opt	
COMPO *4				71-140	71-140						
Installation	Cleaning-free Pipe Reuse	●	●	●	●	●	●			●	
	Reuse of Existing Wiring										
	Wiring/Piping Correction Function										
	Drain Pump	●	●	●	●	●	Opt				
	Pump Down Switch										
	Flare Connection	●	●	●	●	●	●	●		●	
Maintenance	Self-Diagnosis Function (Check Code Display)	●	●	●	●	●	●	●	●	●	
	Failure Recall Function	●	●	●	●	●	●	●	●	●	

*1 SLZ-M15 can be connected with R32 MX2 only.

*2 This function is only available with PAR-41MAA, PAC-YT52CRA, PAR-SL101A-E.

*3 Please refer to "System Control" on pages for details.

*4 Please refer to page 57 for details.

*5 PEAD-M JAL are not equipped with a drain pump.

● If a numerical figure is listed, the feature is only available with the outdoor unit of that capacity.

● Opt: Optional parts must be purchased.

FUNCTION LIST (3)

Category	Icon	P SERIES																
		Combination	PEAD-M35/50/60/71/100/125/140JA(L)2					PEA-M200/250LA2				PKA-M35/50LA(L)2						
			Indoor unit	PUHZ -SHW	PUZ -ZM	PUHZ -ZRP	PUZ -M	PUHZ -P	SUZ -M	SUZ -KA	PUZ -ZM	PUHZ -ZRP	PUZ -M	PUHZ -P	PUZ -ZM	PUHZ -ZRP	PUZ -M	
Function merit-up	3D Total Flow																	
	2+1 Back-up rotation		●			●				●		●		●		●		
	Extended cooling set temperature range												●		●			
	Display of model names and serial numbers		●			●				●		●		●		●		
	Display of power consumption		●			●		●		●		●		●		●		
	Avoiding simultaneous defrosting		●			●				●		●		●		●		
	Defrosting when people are absent																	
	Defrosting when operation is stopped		●							●				●				
	Collection of operation data via MELCloud		●			●				●		●		●		●		
	Demand control via MELCloud		●			●				●		●		●		●		
Notification of potential abnormality via MELCloud		●			●				●		●		●		●			
Technology	DC Inverter	●	●	●	●	●	●	●	●	●	●	●	●	●	●	●		
	Joint Lap DC Motor		35-71	35-71	100	100	●	●					35-71	35-71	100			
	Magnetic Flux Vector Sine Wave Drive	●	●	●	●	●				●	●	●	●	●	●	●		
	Reluctance DC Rotary Compressor		35-71	35-71	100-140	100-140	●	●					35-71	35-71	●			
	Highly Efficient DC Scroll Compressor	●	100-250	100-250	200/250	200/250				●	●	●	●	100-200	100-200			
	Heating Caulking (Compressor)		35-71	35-71	100	100	●	●					35-71	35-71				
	DC Fan Motor	●	●	●	●	●	●	●		●	●	●	●	●	●	●		
	Vector-Wave Eco Inverter	●	●	●	●	●				●	●	●	●	●	●	●		
	PAM (Pulse Amplitude Modulation)	●	35-140	35-140	100-140V	100-140V	●	●					35-140	35-140	100V-140V			
	Power Receiver and Twin LEV Control	●	35-250	35-140	100-250	100-140				●		●		35-200	35-140	100-140		
Grooved Piping	●	●	●	●	●	●	●		●	●	●	●	●	●	●			
i-see Sensor	Felt Temperature Control (3D i-see Sensor)																	
	AREA Temperature Monitor																	
	Energy Saving	Demand Function	Opt	Opt	Opt	Opt	Opt				Opt	Opt	Opt	Opt	Opt	Opt		
		Attractive												●	●	●		
	Air Quality	Auto Vane												●	●	●		
		Fresh-air Intake																
	Air Distribution	High-efficiency Filter																
		Oil Mist Filter																
		Long-life Filter	●	●	●	●	●	●	●	Opt	Opt	Opt	Opt					
		Filter Check Signal	●	●	●	●	●	●	●	●	●	●	●	●	●	●	●	
Convenience	Horizontal Vane												●	●	●			
	Vertical Vane																	
System Control	High Ceiling Mode																	
	Low Ceiling Mode																	
	Auto Fan Speed Mode	●	●	●	●	●	●	●	●	●	●	●	●	●	●	●		
	On/off Operation Timer	●	●	●	●	●	●	●	●	●	●	●	●	●	●	●		
	Auto Changeover	●	●	●	●	●	●	●	●	●	●	●	●	●	●	●		
	Auto Restart	●	●	●	●	●	●	●	●	●	●	●	●	●	●	●		
	Low-temperature Cooling	●	●	●	●	●	●	●	●	●	●	●	●	●	●	●		
	Low-noise Operation (Outdoor Unit)	●	●	●	●	●	●	●	●	●	●	●	●	●	●	●		
Installation	Ampere Limit Adjustment	112/140	60-140V	60-140V 200/250						●			71-140V	71-140V 200				
	Operation Lock																	
	Rotation, Back-up and 2nd Stage Cut-in Functions	●	●	●	●	●				●		●		●	●	●		
	Dual Set Point *1	●	●	●	●	●				●	●	●	●	●	●	●		
	Maintenance	PAR-41MAA Control *2	Opt	Opt	Opt	Opt	Opt	Opt	Opt	Opt	Opt	Opt	Opt	Opt	Opt	Opt	Opt	
		PAR-CT01MAA Control *2	Opt	Opt	Opt	Opt	Opt	Opt	Opt	Opt	Opt	Opt	Opt	Opt	Opt	Opt	Opt	
		PAC-YT52CRA Control *2	Opt	Opt	Opt	Opt	Opt	Opt	Opt	Opt	Opt	Opt	Opt	Opt	Opt	Opt	Opt	
		Centralised On/Off Control *2	Opt	Opt	Opt	Opt	Opt	Opt	Opt	Opt	Opt		Opt	Opt	Opt	Opt	Opt	
		System Group Control *2	●	●	●	●	●	●	●	Opt	Opt	●	●	●	●	Opt	Opt	Opt
		M-NET Connection *2	Opt	Opt	Opt	Opt	Opt	Opt	Opt	Opt	Opt	Opt	Opt	Opt	Opt	Opt	Opt	
Maintenance	COMPO *3	●	71-250	71-250	●	●				●	●	●		71-200	71-200	●		
	Cleaning-free Pipe Reuse	●	●	●	●	●	●	●	●	●	●	●	●	●	●	●		
	Reuse of Existing Wiring	Opt	Opt	Opt	Opt	Opt							Opt	Opt	Opt	Opt		
	Wiring/Piping Correction Function																	
	Drain Pump	●*4	●*4	●*4	●*4	●*4	●*4	●*4	●*4	Opt	Opt	Opt	Opt	Opt	Opt	Opt		
	Pump Down Switch	●	●	●	●	●	●	●	●	●	●	●	●	●	●	●		
Maintenance	Flare Connection	●	●	●	●	●	●	●	●	●	●	●	●	●	●	●		
	Self-Diagnosis Function (Check Code Display)	●	●	●	●	●	●	●	●	●	●	●	●	●	●	●		
	Failure Recall Function	●	●	●	●	●	●	●	●	●	●	●	●	●	●	●		

*1 This function is only available with PAR-41MAA, PAC-YT52CRA, PAR-SL101A-E.

*2 Please refer to "System Control" on pages for details.

*3 Please refer to page 64 for details.

*4 PEAD-M JAL are not equipped with a drain pump.

P SERIES																		
PKA-M60/71/100KA(L)2						PCA-M35/50/60/71/100/125/140KA2						PCA-M71HA2		PSA-M71/100/125/140KA				
PUHZ -P	PUHZ -SHW	PUZ -ZM	PUHZ -ZRP	PUZ -M	PUHZ -P	PUZ -ZM	PUHZ -ZRP	PUZ -M	PUHZ -P	SUZ -M	SUZ -KA	PUZ -ZM	PUHZ -ZRP	PUHZ -ZRP	PUZ -ZM	PUHZ -P	PUZ -M	SUZ -M
		●		●		●		●				●						
		●		●		●		●				●			●		●	
		●		●		●		●				●			●		●	
		●		●		●		●		●		●			●		●	●
		●		●		●		●				●			●		●	
		●		●		●		●				●			●		●	
		●		●		●		●				●			●		●	
●	●	●	●	●	●	●	●	●	●	●	●	●	●	●	●	●	●	●
100		60/71	60/71	100	100	35-71	35-71	100	100	●	●	71	71	71	71	100	100	●
●	●	●	●	●	●	●	●	●	●			●	●	●	●	●	●	
100-140		60/71	60/71	100-140	100-140	35-71	35-71	100-140	100-140	●	●	71	71	71	71	100-140	100-140	●
200	●	100-250	100-250	200/250	200/250	100-250	100-250	200/250	200/250			100-250	100-250	100-250	200-250	200/250	200/250	
		60/71	60/71	100	100	35-71	35-71	100	100	●	●	71	71	71	71	100	100	●
●	●	●	●	●	●	●	●	●	●	●	●	●	●	●	●	●	●	●
●	●	●	●	●	●	●	●	●	●			●	●	●	●	●	●	●
100V-140V	●	60-140	60-140	100-140V	100-140V	35-140	35-140	100-140V	100-140V	●	●	71-140	71-140	71-140	71-140	100-140V	100-140V	●
100-140	●	60-250	60-140	100-250	100-140	35-250	35-140	100-250	100-140			71-250	71-140	71-140	71-250	100-140	100-250	
●	●	●	●	●	●	●	●	●	●	●	●	●	●	●	●	●	●	●
Opt	Opt	Opt	Opt	Opt	Opt	Opt	Opt	Opt	Opt			Opt	Opt	Opt	Opt	Opt	Opt	
●	●	●	●	●	●	●	●	●	●	●	●			●	●	●	●	●
●	●	●	●	●	●	●	●	●	●	●	●							
						Opt	Opt	Opt	Opt	Opt	Opt	●	●					
						●	●	●	●	●	●	●	●	●	●	●	●	●
Opt	Opt	Opt	Opt	Opt	Opt	●	●	●	●	●	●	●	●	●	●	●	●	●
●	●	●	●	●	●	●	●	●	●	●	●							
						●	●	●	●	●	●			●	●	●	●	●
●	●	●	●	●	●	●	●	●	●	●	●			●	●	●	●	●
●	●	●	●	●	●	●	●	●	●	●	●			●	●	●	●	●
●	●	●	●	●	●	●	●	●	●	●	●			●	●	●	●	●
●	●	●	●	●	●	●	●	●	●	●	●			●	●	●	●	●
	112/140	60-140V	60-140V 200/250			60-140V	60-140V 200/250						71-140V 200/250	71-140V 200/250	71-140V			
●	●	●	●	●	●	●	●	●	●	●	●			●	●	●	●	●
●	●	●	●	●	●	●	●	●	●	●	●			●	●	●	●	●
Opt	Opt	Opt	Opt	Opt	Opt	Opt	Opt	Opt	Opt	Opt	Opt	Opt	Opt	●	●	●	●	●
Opt	Opt	Opt	Opt	Opt	Opt	Opt	Opt	Opt	Opt	Opt	Opt	Opt	Opt					
Opt	Opt	Opt	Opt	Opt	Opt	Opt	Opt	Opt	Opt	Opt	Opt	Opt	Opt					
Opt	Opt	Opt	Opt	Opt	Opt	Opt	Opt	Opt	Opt	Opt	Opt	Opt	Opt	Opt	Opt	Opt	Opt	Opt
Opt	Opt	Opt	Opt	Opt	Opt	Opt	Opt	Opt	Opt	Opt	Opt	Opt	Opt	Opt	Opt	Opt	Opt	Opt
●	●	71-250	71-250	●	●	71-250	71-250	●	●	●	●	71-250	71-250	71-250	71-250	●	●	●
●	●	●	●	●	●	●	●	●	●	●	●			●	●	●	●	●
Opt	Opt	Opt	Opt	Opt	Opt	Opt	Opt	Opt	Opt	Opt	Opt	Opt	Opt	Opt	Opt	Opt	Opt	Opt
Opt	Opt	Opt	Opt	Opt	Opt	Opt	Opt	Opt	Opt	Opt	Opt							
●	●	●	●	●	●	●	●	●	●	●	●	●	●	●	●	●	●	●
●	●	●	●	●	●	●	●	●	●	●	●	●	●	●	●	●	●	●
●	●	●	●	●	●	●	●	●	●	●	●	●	●	●	●	●	●	●
●	●	●	●	●	●	●	●	●	●	●	●	●	●	●	●	●	●	●

● If a numerical figure is listed, the feature is only available with the outdoor unit of that capacity.
 ● Opt: Optional parts must be purchased.

FUNCTION LIST (4)

Category	Icon	Series Outdoor unit	MXZ SERIES														
			Std					Lo-std		H2i		Lo-std		Std			
			MXZ-VA(2)					MXZ-VA		MXZ-VA		MXZ-VF		MXZ-VF4			
			2D	3E	4E	5E	6D	2DM	3DM	2E	4E	2HA	3HA	2F	3F	4F	
Technology	DC Inverter		●	●	●	●	●	●	●	●	●	●	●	●	●	●	
	Joint Lap DC Motor		●	●	●	●		●	●	●		●	●	●	●	●	
	Magnetic Flux Vector Sine Wave Drive																
	Reluctance DC Rotary Compressor				83	●	●										
	Highly Efficient DC Scroll Compressor																
	Heating Caulking (Compressor)		●	●	●	●	●	●	●	●	●	●	●	●	●	●	
	DC Fan Motor		●	●	●	●	●	●	●	●	●	●	●	●	●	●	
	Vector-Wave Eco Inverter																
	PAM (Pulse Amplitude Modulation)		●	●	●	●	●	●	●	●	●	●	●	●	●	●	
	Power Receiver and Twin LEV Control			●	72			●				●		●	●	●	
Grooved Piping		●	●	●	●	●	●	●	●	●	●	●	●	●	●		
i-see Sensor	Felt Temperature Control (3D i-see)																
	AREA Temperature Monitor																
	Energy Saving	Demand Function															
		Pure White															
	Attractive	Auto Vane															
		Fresh-air Intake															
	Air Quality	High-efficiency Filter															
		Oil Mist Filter															
		Filter Check Signal															
	Air Distribution	Horizontal Vane															
Vertical vane																	
High Ceiling Mode																	
Auto Fan Speed Mode																	
Convenience	On/off Operation Timer																
	Auto Changeover		●	●	●	●	●	●	●	●	●	●	●	●	●	●	
	Auto Restart		●	●	●	●	●	●	●	●	●	●	●	●	●	●	
	Low- temperature Cooling		●	●	●	●	●	●	●	●	●	●	●	●	●	●	
	10°C Heating		●*1	●*1	●*1	●*1	●*1		●*1	●*1			●*1	●*1	●*1		
	Low-noise Operation (Outdoor)		●	●	●	●	●	●	●	●	●	●	●	●	●	●	
	Night Mode																
	Ampere Limit Adjustment				83	●	●		●	●							
	Operation Lock (Indoor)																
	Operation Lock (Outdoor)		●	●	●	●	●	●	●	●	●	●	●	●	●	●	
System Control	PAR-41MAA Control		Opt	Opt	Opt	Opt	Opt	Opt	Opt	Opt	Opt	Opt	Opt	Opt	Opt	Opt	
	PAR-CT01MAA Control		Opt	Opt	Opt	Opt	Opt	Opt	Opt	Opt	Opt	Opt	Opt	Opt	Opt	Opt	
	PAC-YT52CRA Control		Opt	Opt	Opt	Opt	Opt	Opt	Opt	Opt	Opt	Opt	Opt	Opt	Opt	Opt	
	Centralised On/off Control		Opt	Opt	Opt	Opt	Opt	Opt	Opt	Opt	Opt	Opt	Opt	Opt	Opt	Opt	
	System Group Control		Opt	Opt	Opt	Opt	Opt	Opt	Opt	Opt	Opt	Opt	Opt	Opt	Opt	Opt	
	M-NET Connection				Opt (83)	Opt	Opt		Opt	Opt							
	Wi-Fi Interface																
	Energy/Consumption Monitoring through MEL Cloud																
	COMPO																
	MXZ Connection		●*2	●*2	●*2	●*2	●*2	●*2	●*2	●*2	●*2	●*2	●*2	●*2	●*2	●*2	
Installation	Cleaning-free Pipe Reuse											●*3	●*3	●*3	●*3	●*3	
	Reuse of Existing Wiring																
	Wiring/Piping Correction Function		●	●	●	●	●	●	●	●	●	●	●	●	●	●	
	Drain Pump																
	Pump Down Switch			●	●	●	●		●		●		●		●	●	
	Flare Connection		●	●	●	●	●	●	●	●	●	●	●	●	●	●	
Maintenance	Self-Diagnosis Function (Check Code Display)		●	●	●	●	●	●	●	●	●	●	●	●	●	●	
	Failure Recall Function		●	●	●	●	●	●	●	●	●	●	●	●	●	●	

*1 When multiple indoor units connected to an MXZ outdoor unit are running at the same time, simultaneous cooling and heating is not possible.



*2 For the possible connectivity of MXZ outdoor units and indoor units, please refer to the list on pages 139-140 for details.

*3 Please refer to "System Control" on pages for details.

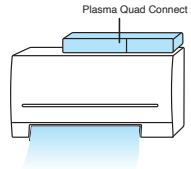
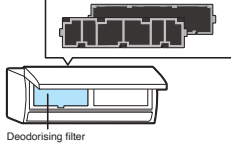
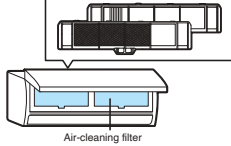
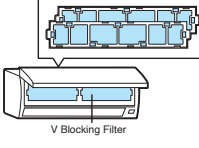
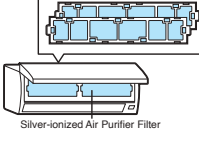
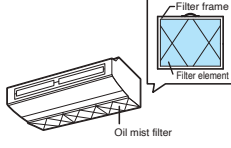
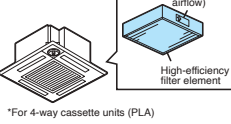
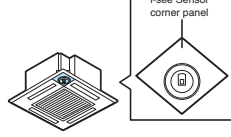
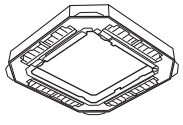
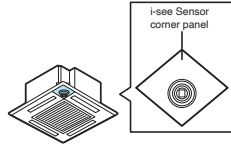
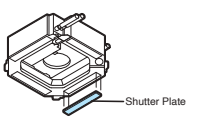
Major Optional Parts

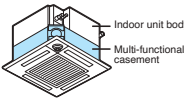
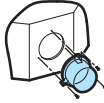
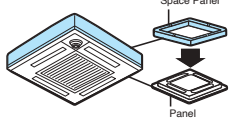
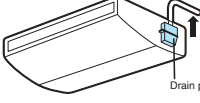
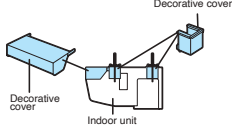
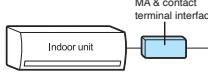
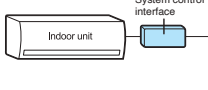
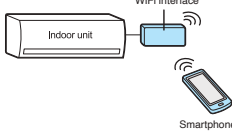
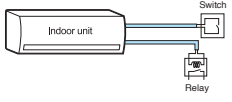
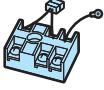
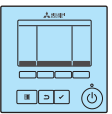
Part Name	Description
Plasma Quad Connect High performance air purifying device that effectively removes various kinds of air pollutants and is even installable on the existing indoor unit.	 <p>Plasma Quad Connect</p>
Deodorising Filter Captures small foul-smelling substances in the air.	 <p>Deodorising filter</p>
Air-cleaning Filter Removes fine dust particles from the air by means of static electricity.	 <p>Air-cleaning filter</p>
V Blocking Filter Inhibits 99% of adhered virus, and other harmful substances, such as bacteria, mold and allergen.	 <p>V Blocking Filter</p>
Silver-ionized Air Purifier Filter Captures the bacteria, pollen and other allergens in the air and neutralises them.	 <p>Silver-ionized Air Purifier Filter</p>
Oil Mist Filter Element Filter element (12 pieces) that blocks the oil mist for ceiling-suspended models used in professional kitchens.	 <p>Filter frame Filter element Oil mist filter</p>
High-efficiency Filter Element Element for high-efficiency filter. Removes fine dust particles from the air.	 <p>Plug (for directing airflow) High-efficiency filter element *For 4-way cassette units (PLA)</p>
3D i-see Sensor Corner Panel for SLZ Corner panel holding the 3D i-see Sensor.	 <p>i-see Sensor corner panel</p>
3D Total Flow for PLA Casement equipped with horizontal louver.	
3D i-see Sensor Corner Panel for PLA Corner panel holding the 3D i-see Sensor.	 <p>i-see Sensor corner panel</p>
Shutter Plate Plate for blocking an air outlet of the 4-way cassette (PLA) indoor unit.	 <p>Shutter Plate</p>

Part Name	Description
Multi-functional Casement Casement for fresh-air intake and attaching the high-efficiency filter element (optional).	 <p>Indoor unit body Multi-functional casement</p>
Fresh-air Intake Duct Flange Flange attachment for adding a duct to take in fresh air from outside.	 <p>*For 4-way cassette units (PLA)</p>
Space Panel Decorative cover for the installation when the ceiling height is low.	 <p>Space Panel Panel</p>
Drain Pump Pumps drain water to a point higher than that where the unit is installed.	 <p>Drain pump *for ceiling-suspended units</p>
Decorative Cover To be attached to the upper section of ceiling-suspended models for professional kitchen use. Helps prevent dust accumulation.	 <p>Decorative cover Decorative cover Indoor unit</p>
MA Interface Interface for connecting with the PAR-41MAA remote controller and PAC-YT52CRA.	 <p>MA & contact terminal interface Indoor unit</p>
System Control Interface Interface to connect with M-NET controllers.	 <p>System control interface Indoor unit</p>
Wi-Fi Interface Interface enabling users to control air conditioners and check operating status via devices such as personal computers, tablets and smartphones.	 <p>WiFi interface Indoor unit Smartphone</p>
Connector Cable This product is an adaptor which inputs the incoming signals from an open/close switch to the air conditioner and outputs the on/off signals from the air conditioner.	 <p>Switch Indoor unit Relay</p>
Power Supply Terminal Kit Terminal bed to change the power supply from outdoor power supply to separate indoor/outdoor power supplies.	
Wired Remote Controller Advanced deluxe remote controller with full-dot liquid-crystal display and backlight. Equipped with convenient functions like night-setback.	

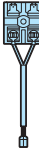
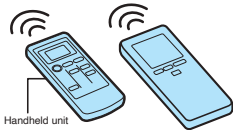
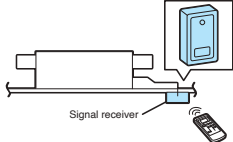
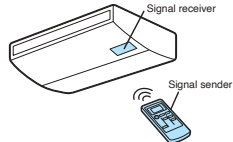
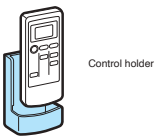
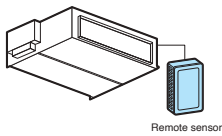
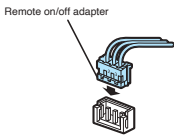
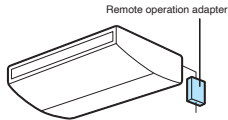
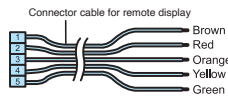
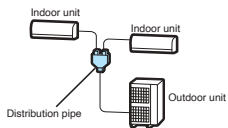
Part Name	Description
MA Touch Remote Controller Remote controller with the full color touch display. Smartphone/Tablet App is available for setting, customize and control.	
Simple Wired Remote Controller Remote controller with liquid-crystal display, and backlight function for operation in dark location.	
Remote Controller Terminal Block Kit for PKA The terminal block is used as a relay to wire an indoor unit and to two remote controllers or to wire a remote controller and multiple indoor units in order to perform group control.	
Wireless Remote Controller Signal Sender Handheld unit for sending operation signals to the indoor unit.	
Wireless Remote Controller Signal Receiver Receives operation signals from the wireless remote controller handheld unit.	
Wireless Remote Controller Kit (Sender & Receiver) Remote controller handheld unit (signal sender) and receiver (signal receiver) for ceiling-suspended units.	
Control Holder Holder for storing the remote controller.	
Remote Sensor Sensor to detect the room temperature at remote positions.	
Remote On/Off Adapter Connector for receiving signals from the local system to control the on/off function.	
Remote Operation Adapter Adapter to display the operation status and control on/off function from a distance.	
Connector Cable for Remote Display Connector used to display the operation status and control on/off function from a distance.	
Distribution Pipe Branch pipe for P Series simultaneous multi-system use, or to connect two branch boxes for PUMY.	

*P Series with 2 indoor units

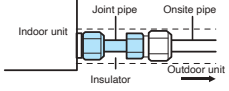
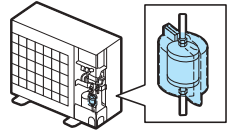
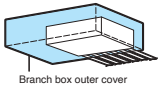
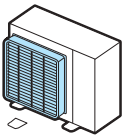
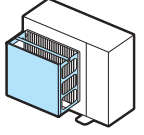
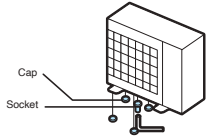
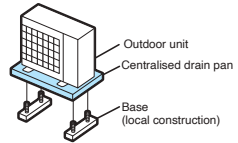
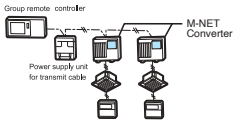
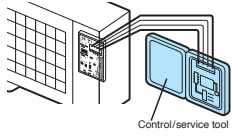
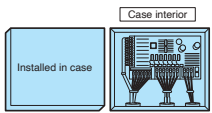
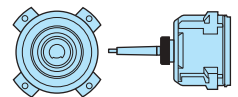
Part Name	Description
Joint Pipe Part for connecting refrigerant pipes of different diameters.	
Liquid Refrigerant Dryer Removes water and minute particles from refrigerant pipes.	
Branch Box Outer Cover Casement for branch boxes.	
Air Discharge Guide Changes the direction of air being exhausted from the outdoor unit.	
Air Protection Guide Protects the outdoor unit from the wind.	
Drain Socket A set of caps to cover unnecessary holes at the bottom of the outdoor unit, and a socket to guide drain water to the local drain pipe.	
Centralised Drain Pan Catches drain water generated by the outdoor unit.	
M-NET Converter Used to connect P Series A-control models to M-NET controllers.	
Control/Service Tool Monitoring tool to display operation and self-diagnosis data.	
Step Interface Interface for adjusting the capacity of inverter-equipped outdoor units.	
High-static Fan Motor Static pressure enhanced up to +30pa.	

Optional Parts List <Indoor>

Indoor Unit		Option	Fresh-air Intake Duct Flange		Space Panel	Drain Pump						Decorative Cover	System Control Interface	Wi-Fi Interface	
			PAC-SH65 OF-E	PAC-SF28 OF-E	PAC-SJ65 AS-E	PAC-SK19 DM-E	PAC-SK01 DM-E	PAC-SJ92 DM-E	PAC-SJ93 DM-E	PAC-SJ94 DM-E	PAC-KE07 DM-E	PAC-KE06 DM-FI	PAC-SF81 KC-E	MAC-334 IF-E	MAC-587 IF-E
S SERIES	4-way cassette	SLZ-M15FA2												●	●
		SLZ-M25FA2												●	●
		SLZ-M35FA2												●	●
		SLZ-M50FA2												●	●
		SLZ-M60FA2												●	●
	Ceiling - conceald	SEZ-M25DA(L)2									●			●	●
		SEZ-M35DA(L)2									●			●	●
		SEZ-M50DA(L)2									●			●	●
		SEZ-M60DA(L)2									●			●	●
		SEZ-M71DA(L)2									●			●	●
	Concealed floor standing	SFZ-M25VA												●	●
		SFZ-M35VA												●	●
		SFZ-M50VA												●	●
		SFZ-M60VA												●	●
		SFZ-M71VA												●	●
P SERIES	4-way Cassette	PLA-ZM35EA2	●		●									● ^{*1}	●
		PLA-ZM50EA2	●		●									● ^{*1}	●
		PLA-ZM60EA2	●		●									● ^{*1}	●
		PLA-ZM71EA2	●		●									● ^{*1}	●
		PLA-ZM100EA2	●		●									● ^{*1}	●
		PLA-ZM125EA2	●		●									● ^{*1}	●
		PLA-ZM140EA2	●		●									● ^{*1}	●
		PLA-M35EA2	●		●									● ^{*1}	●
		PLA-M50EA2	●		●									● ^{*1}	●
		PLA-M60EA2	●		●									● ^{*1}	●
		PLA-M71EA2	●		●									● ^{*1}	●
		PLA-M100EA2	●		●									● ^{*1}	●
		PLA-M125EA2	●		●									● ^{*1}	●
	PLA-M140EA2	●		●									● ^{*1}	●	
	Ceiling - conceald	PEAD-M35JA(L)2												● ^{*1}	●
PEAD-M50JA(L)2													● ^{*1}	●	
PEAD-M60JA(L)2													● ^{*1}	●	
PEAD-M71JA(L)2													● ^{*1}	●	
PEAD-M100JA(L)2													● ^{*1}	●	
PEAD-M125JA(L)2													● ^{*1}	●	
PEAD-M140JA(L)2													● ^{*1}	●	
PEA-M200LA2											●		● ^{*1}	●	
PEA-M250LA2											●		● ^{*1}	●	
Wall - mounted	PKA-M35LA(L)2						●						● ^{*1}	●	
	PKA-M50LA(L)2						●						● ^{*1}	●	
	PKA-M60KA(L)2				●								● ^{*1}	●	
	PKA-M71KA(L)2				●								● ^{*1}	●	
	PKA-M100KA(L)2				●								● ^{*1}	●	
Ceiling - suspended	PCA-M35KA2						●						● ^{*1}	●	
	PCA-M50KA2						●						● ^{*1}	●	
	PCA-M60KA2								●				● ^{*1}	●	
	PCA-M71KA2							●					● ^{*1}	●	
	PCA-M100KA2							●					● ^{*1}	●	
	PCA-M125KA2							●					● ^{*1}	●	
	PCA-M140KA2							●					● ^{*1}	●	
	PCA-M71HA2		●									●	● ^{*1}	●	
Floor - standing	PSA-M71KA													●	
	PSA-M100KA													●	
	PSA-M125KA													●	
	PSA-M140KA													●	

*1 P Series indoor units can be used in combination with SUZ or MXZ outdoor units. *2 PAC-SH29TC-E is required for wireless model. *3 Group control cannot be used.

External Dimensions

M SERIES

Unit: mm

MUZ-RW25VGHZ MUZ-RW35VGHZ MUZ-RW50VGHZ

INDOOR UNIT

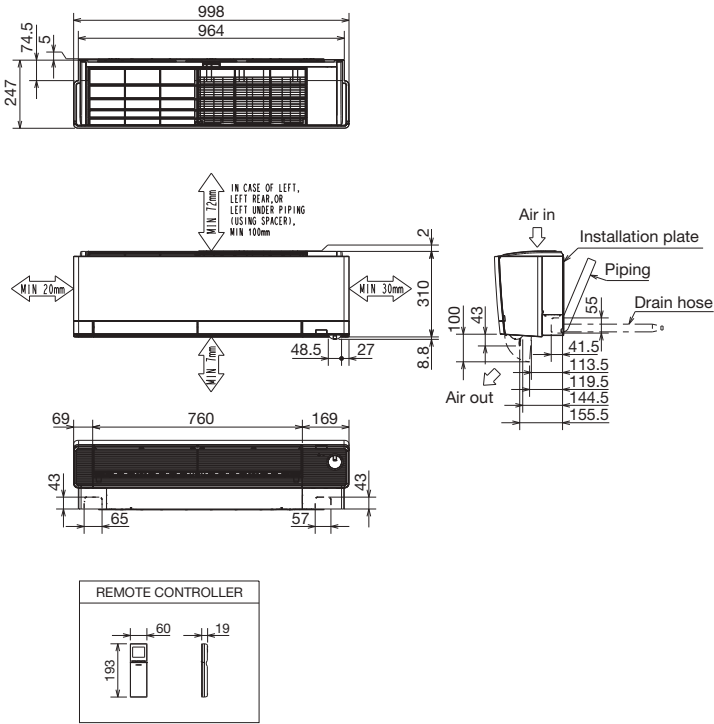

MSZ-LN25VG2(W)(V)(R)(B) MSZ-LN35VG2(W)(V)(R)(B) MSZ-LN50VG2(W)(V)(R)(B) MSZ-LN60VG2(W)(V)(R)(B)

INDOOR UNIT

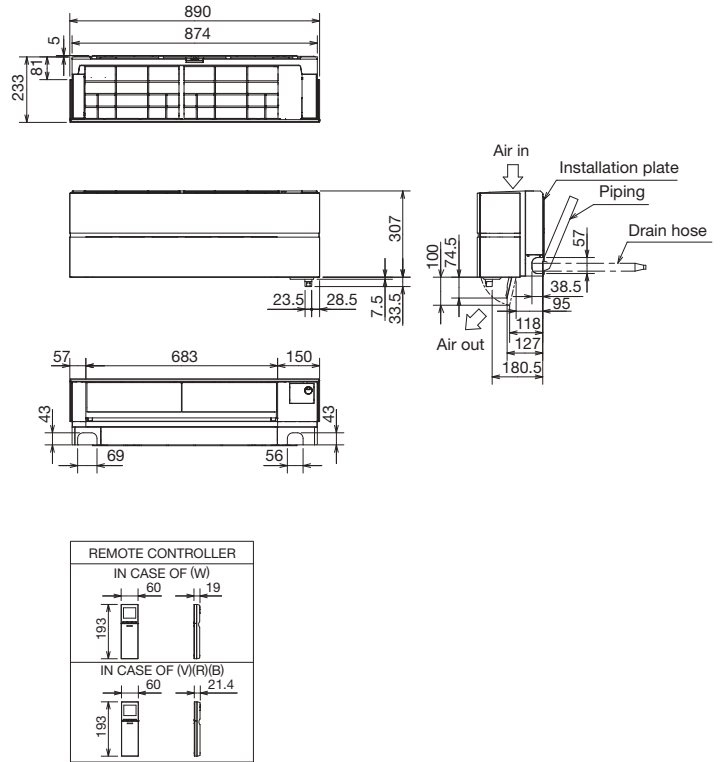

MSZ-FT25VG MSZ-FT35VG MSZ-FT50VG MSZ-FT25VGK MSZ-FT35VGK MSZ-FT50VGK

INDOOR UNIT

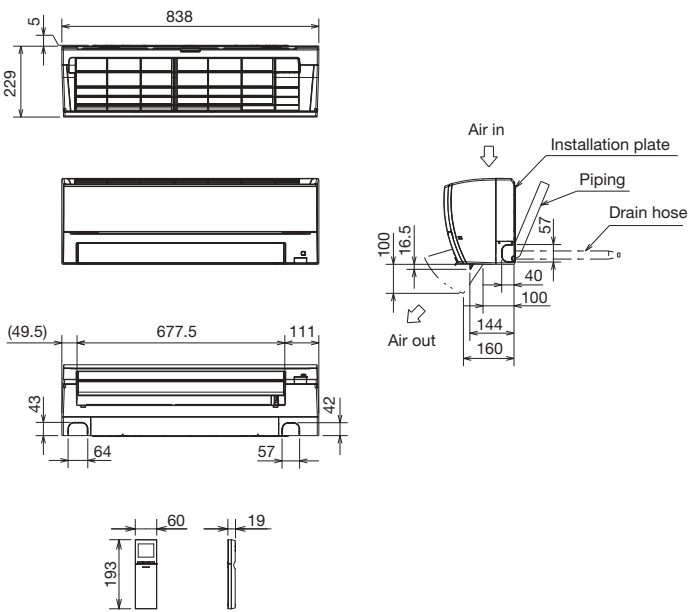

MSZ-AP15VG MSZ-AP20VG

INDOOR UNIT

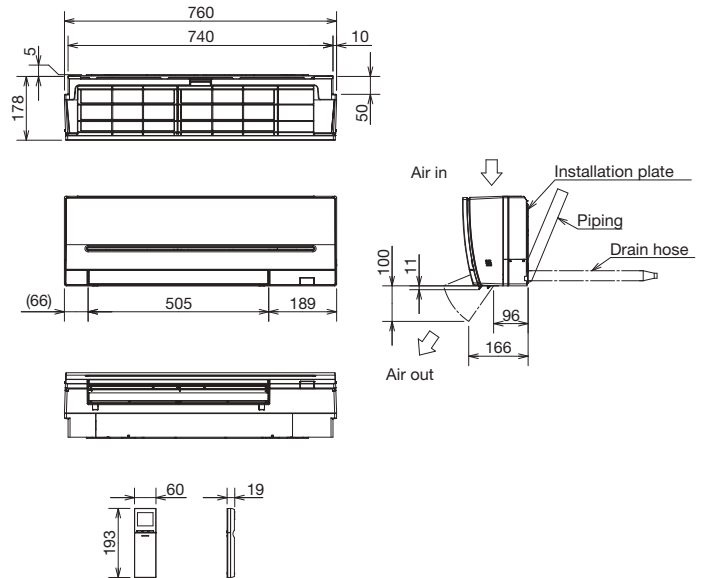

MSZ-AY25VGK(P) MSZ-AY35VGK(P) MSZ-AY42VGK(P)
MSZ-AY50VGK(P)

INDOOR UNIT

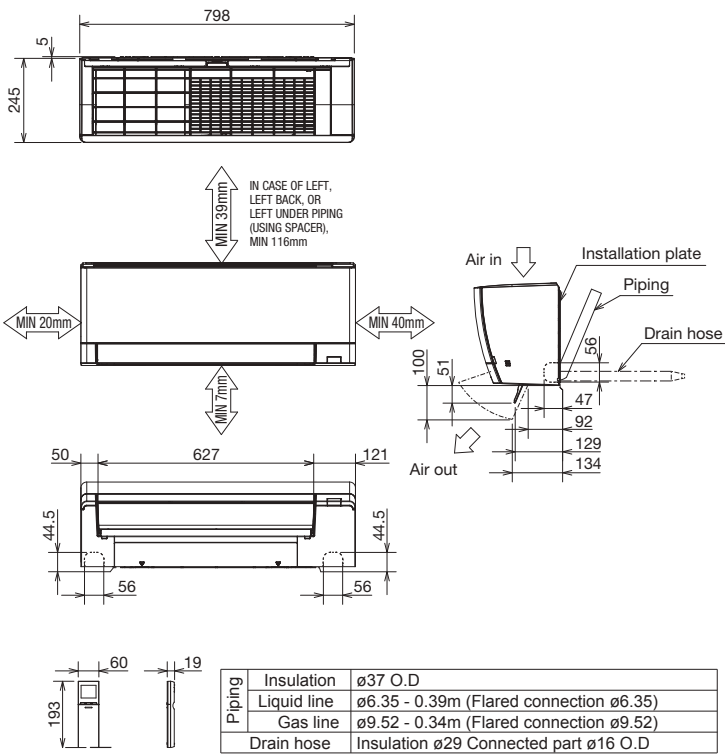

MSZ-AP60VG MSZ-AP71VG
MSZ-AP60VGK MSZ-AP71VGK

INDOOR UNIT

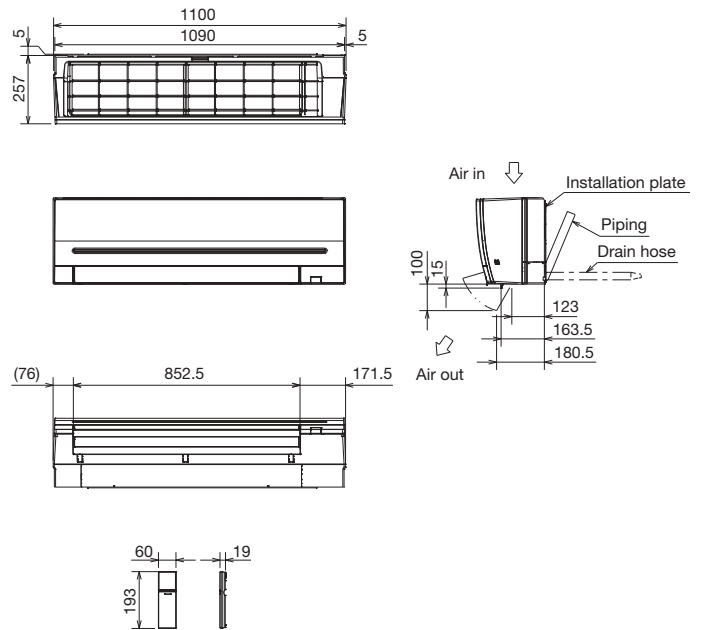

MSZ-EF18VG(W)(B)(S) MSZ-EF22VG(W)(B)(S)
MSZ-EF25VG(W)(B)(S) MSZ-EF35VG(W)(B)(S)
MSZ-EF42VG(W)(B)(S) MSZ-EF50VG(W)(B)(S)
MSZ-EF18VGK(W)(B)(S) MSZ-EF22VGK(W)(B)(S)
MSZ-EF25VGK(W)(B)(S) MSZ-EF35VGK(W)(B)(S)
MSZ-EF42VGK(W)(B)(S) MSZ-EF50VGK(W)(B)(S)

INDOOR UNIT

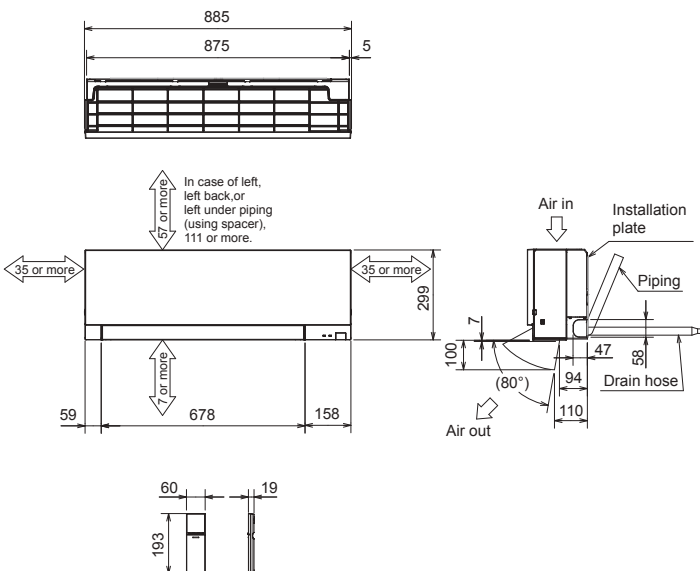

MSZ-BT20VG MSZ-BT25VG MSZ-BT35VG MSZ-BT50VG
MSZ-BT20VGK MSZ-BT25VGK MSZ-BT35VGK MSZ-BT50VGK

INDOOR UNIT

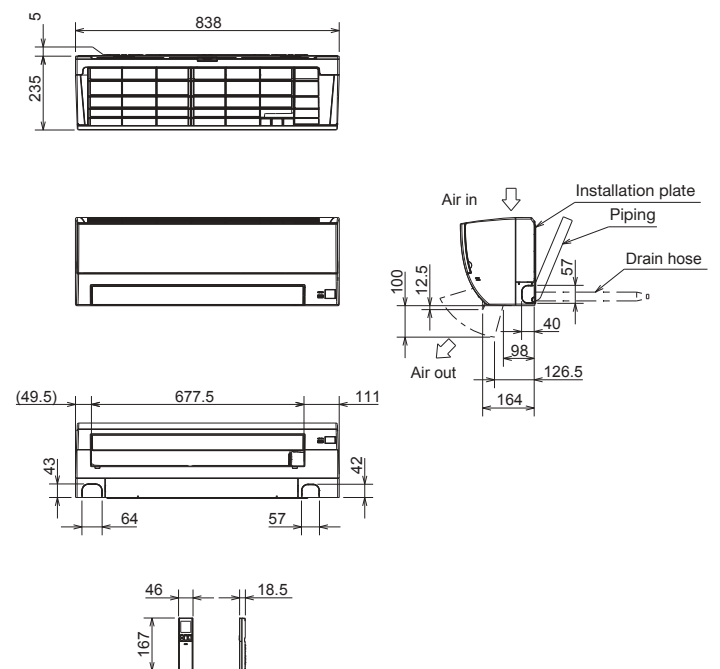

**MSZ-HR25VF(K) MSZ-HR35VF(K) MSZ-HR42VF(K)
MSZ-HR50VF(K)**

INDOOR UNIT

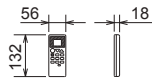
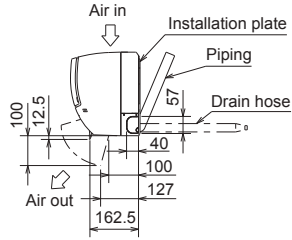
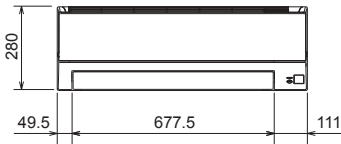
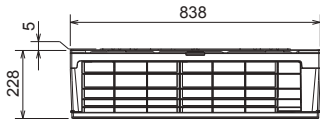

MSZ-HR60VF(K) MSZ-HR71VF(K)

INDOOR UNIT

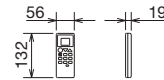
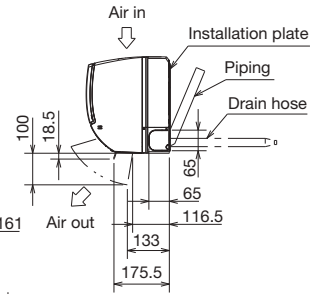
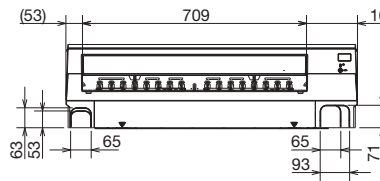
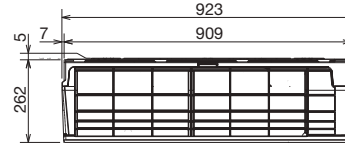

MSZ-DW25VF MSZ-DW35VF MSZ-DW50VF

INDOOR UNIT

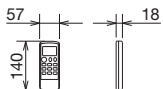
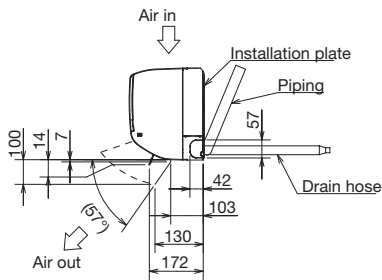
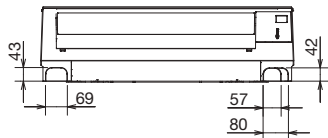
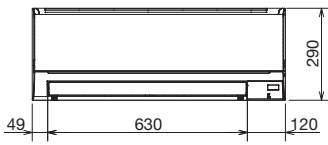
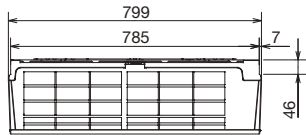

MSZ-FH25VE2 MSZ-FH35VE2 MSZ-FH50VE2

INDOOR UNIT

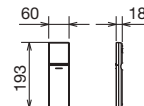
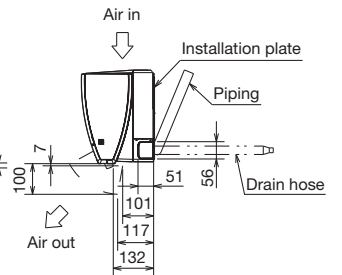
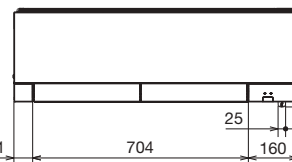
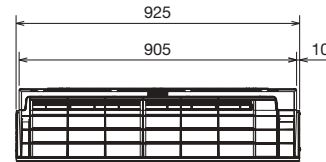

MSZ-SF15VA MSZ-SF20VA

INDOOR UNIT

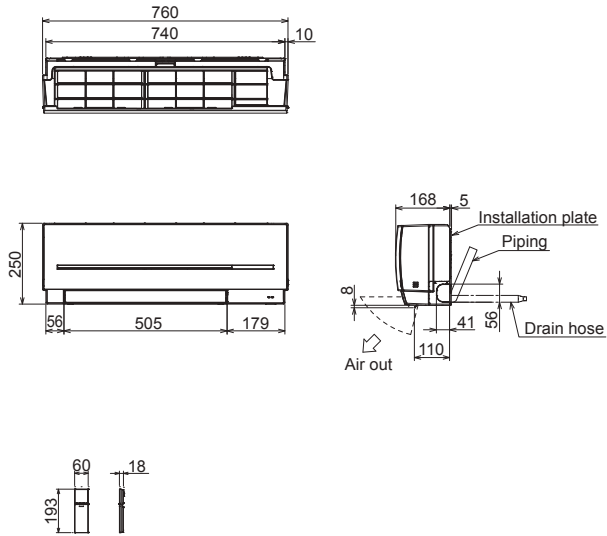

**MSZ-SF25VE3 MSZ-SF35VE3 MSZ-SF42VE3
MSZ-SF50VE3**

INDOOR UNIT

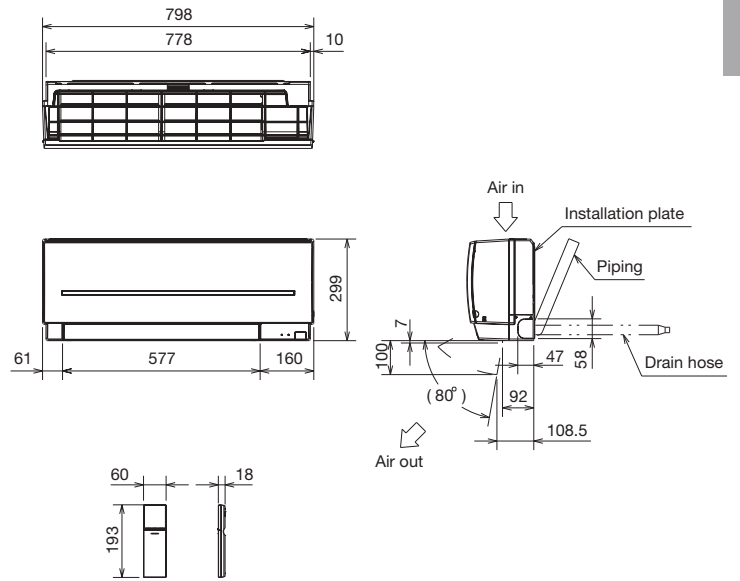

MSZ-GF60VE2 MSZ-GF71VE2

INDOOR UNIT

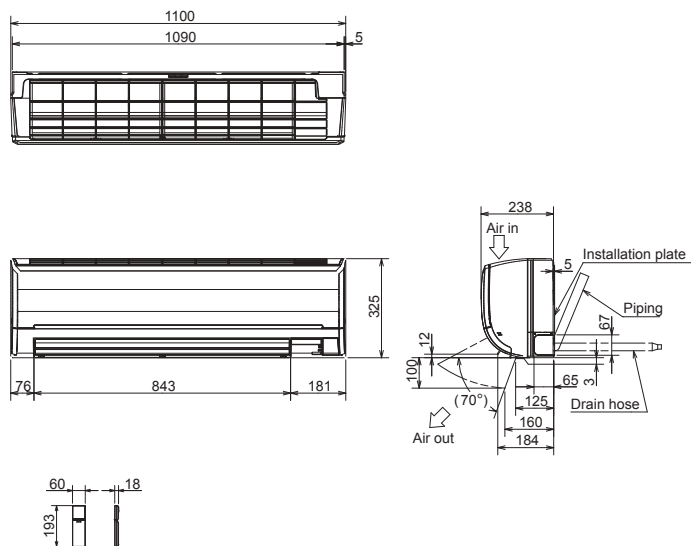

MSZ-WN25VA MSZ-WN35VA

INDOOR UNIT

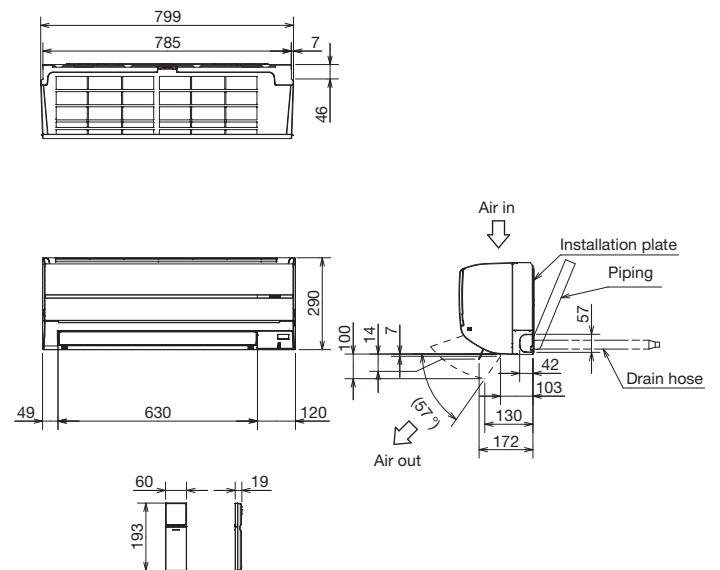

MSZ-DM25VA MSZ-DM35VA

INDOOR UNIT

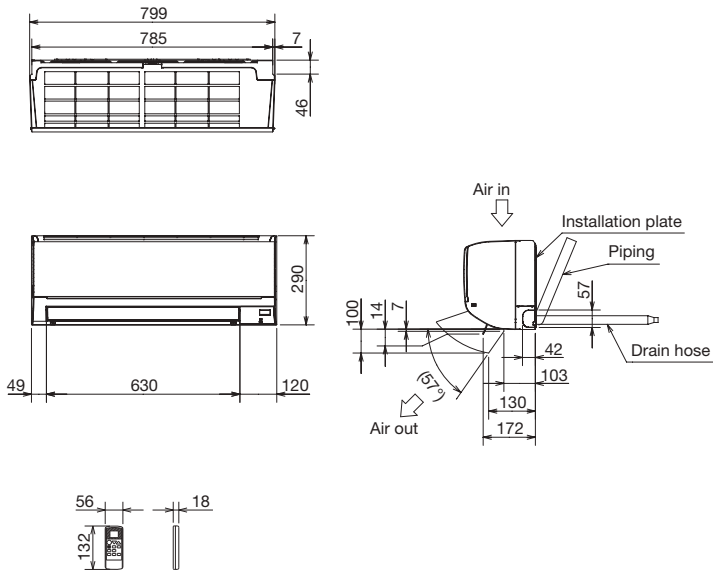

MSZ-HJ25VA MSZ-HJ35VA MSZ-HJ50VA

INDOOR UNIT

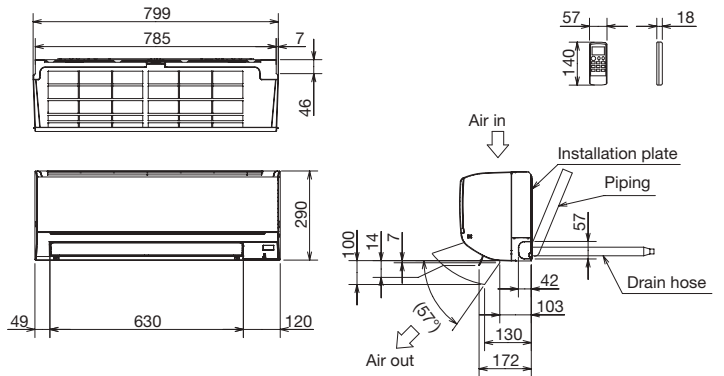

**MSZ-HJ60VA MSZ-HJ71VA
MSY-TP35VF MSY-TP50VF**

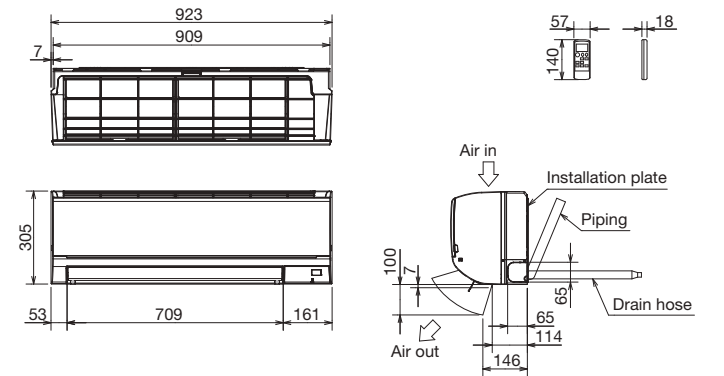

MFZ-KT25VG MFZ-KT35VG MFZ-KT50VG MFZ-KT60VG

INDOOR UNIT

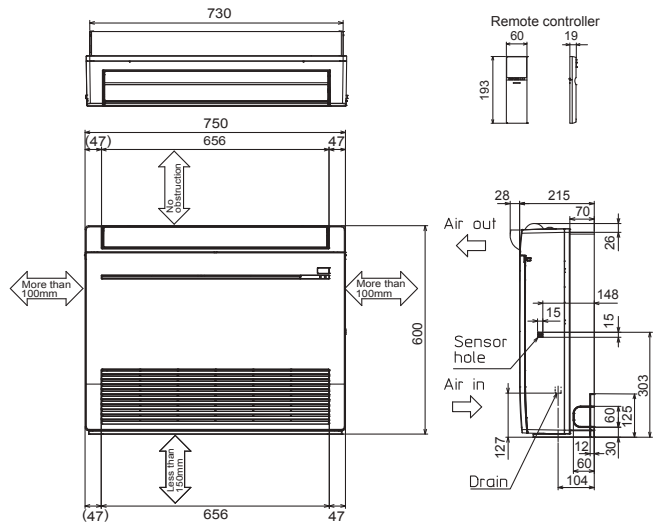

MFZ-KW25VG MFZ-KW35VG MFZ-KW50VG MFZ-KW60VG

INDOOR UNIT

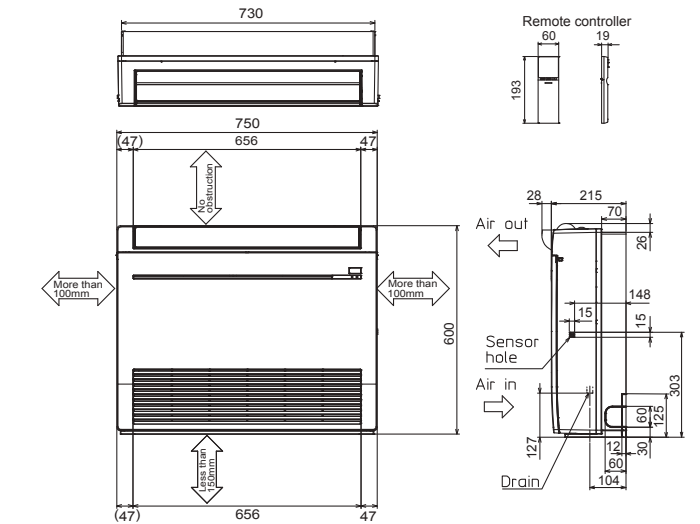

MUZ-LN25VG MUZ-LN25VGHZ
 MUZ-LN35VG MUZ-LN35VGHZ
 MUZ-AP20VG MUZ-AY25VGH
 MUZ-AY25VG MUZ-AY35VGH
 MUZ-AY42VG MUZ-AY42VGH
 MUZ-FT25VGHZ MUZ-FH35VE
 MUZ-FH25VE MUZ-FH35VEHZ
 MUZ-FH25VEHZ MUZ-EF25VGH
 MUZ-EF25VG MUZ-EF35VGH
 MUZ-EF35VG MUZ-TP35VF
 MUZ-EF42VG MUZ-SF25VEH
 MUZ-SF25VE MUZ-SF42VE
 MUZ-SF35VEH MUZ-HJ50VA
 MUZ-HJ50VA MUFZ-KJ35VE
 MUFZ-KJ25VE MUFZ-KJ35VEHZ
 MUFZ-KJ25VEHZ MUFZ-KJ35VEHZ

MUZ-HR42VF
 MUZ-HR50VF
 MUZ-DW50VF
 MUY-TP50VF
 MUZ-SF35VE
 MUZ-SF42VEH
 MUZ-BT50VG

OUTDOOR UNIT

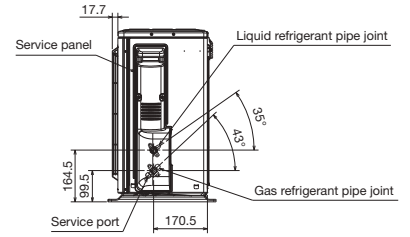
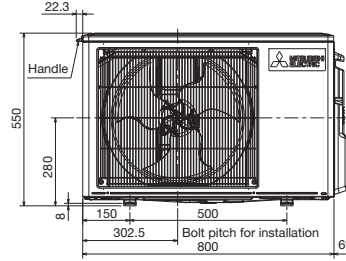
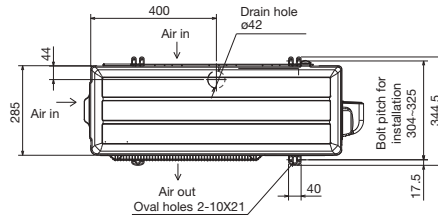

MUZ-FH50VE MUZ-FH50VEHZ MUZ-AP71VG
 MUZ-SF50VE MUZ-SF50VEH
 MUZ-GF60VE MUZ-GF71VE
 MUZ-HJ60VA MUZ-HJ71VA
 MUFZ-KJ50VE MUFZ-KJ50VEHZ

MUZ-AP15VG MUZ-BT20VG

OUTDOOR UNIT

OUTDOOR UNIT

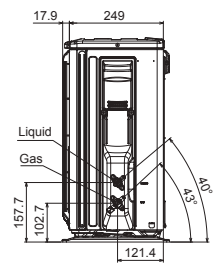
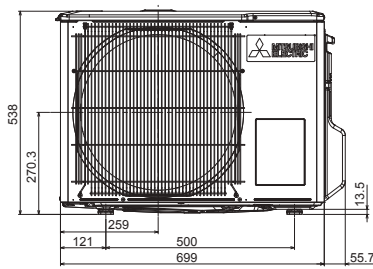
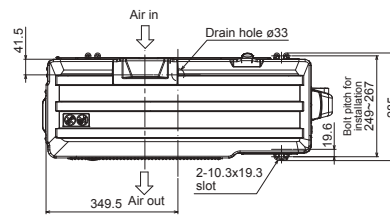
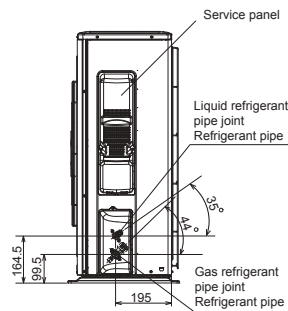
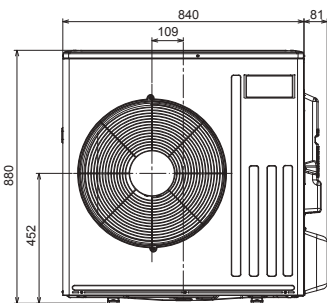
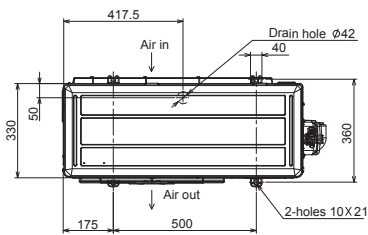

MUZ-WN25VA MUZ-WN35VA MUZ-HR25VF MUZ-BT25VG
MUZ-DM25VA MUZ-DM35VA MUZ-HR35VF MUZ-BT35VG
MUZ-HJ25VA MUZ-HJ35VA
MUZ-DW25VF MUZ-DW35VF

OUTDOOR UNIT

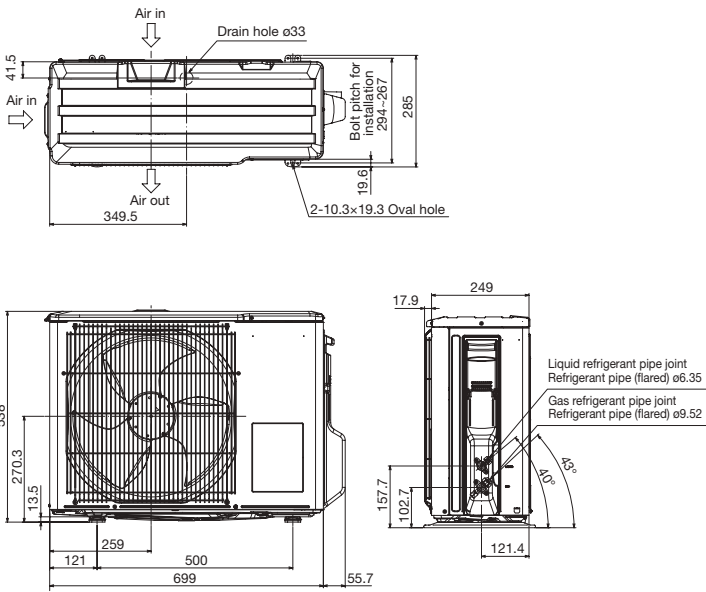

MUZ-RW25VGHZ MUZ-RW35VGHZ
MUZ-LN50VG
MUZ-FT35/50VGHZ
MUZ-AP50VG MUZ-AP50VGH MUZ-AP60VG
MUZ-EF50VG
MUZ-HR60VF MUZ-HR71VF

OUTDOOR UNIT

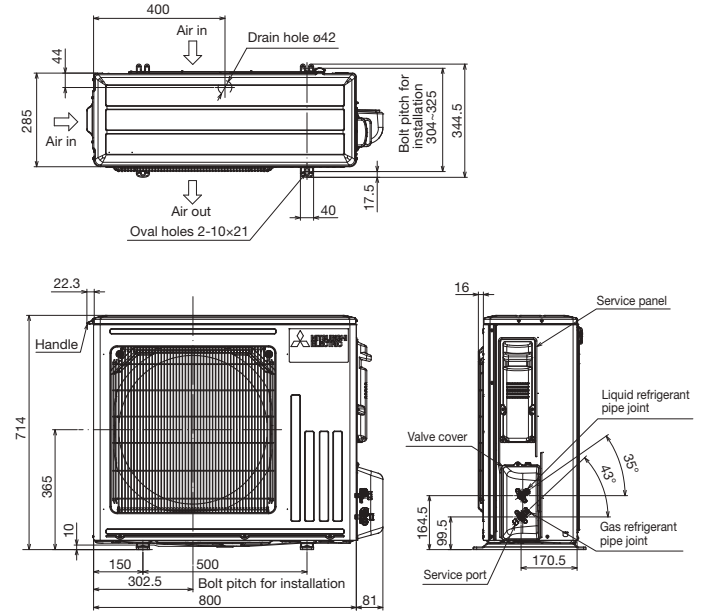

MUZ-RW50VGHZ
MUZ-LN60VG2
MUZ-LN50VGHZ2

OUTDOOR UNIT

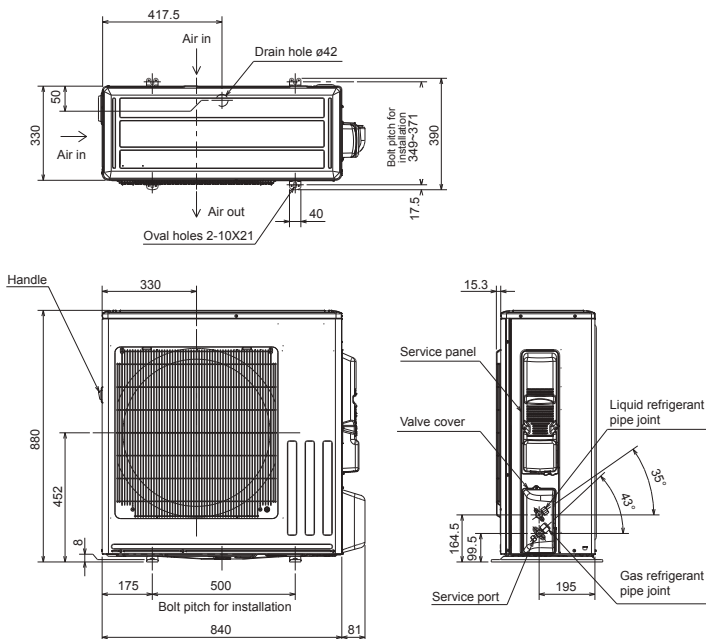

SUZ-M50VA

OUTDOOR UNIT

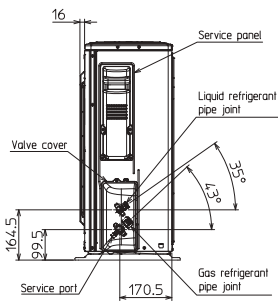
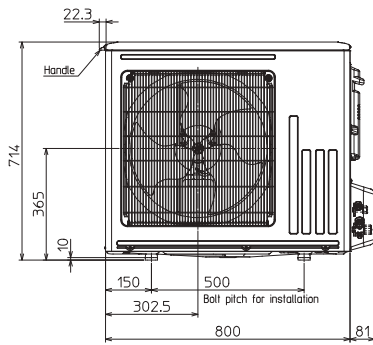
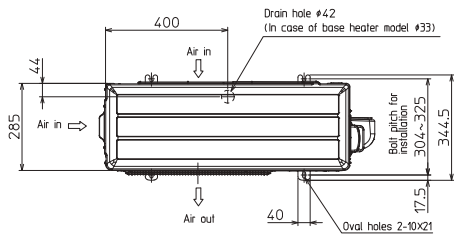

SUZ-M60VA SUZ-M71VA

OUTDOOR UNIT

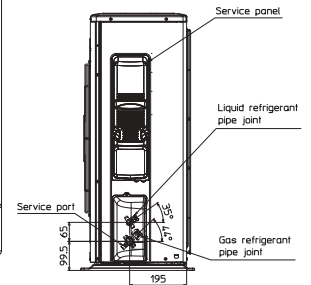
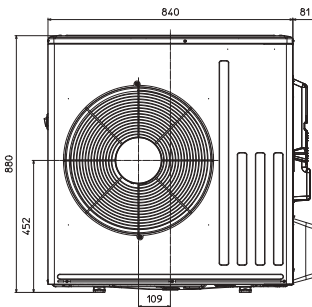
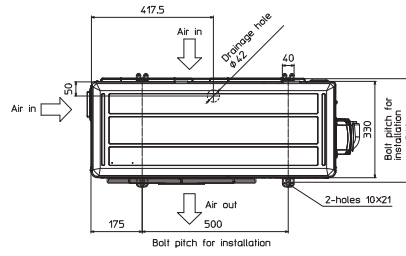

SUZ-KA25VA6 SUZ-KA35VA6

OUTDOOR UNIT

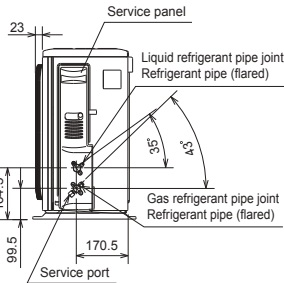
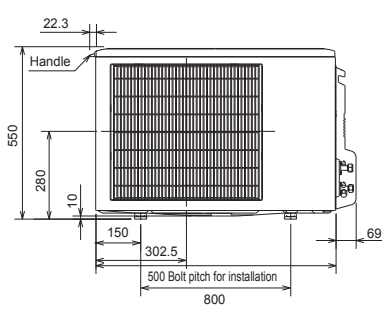
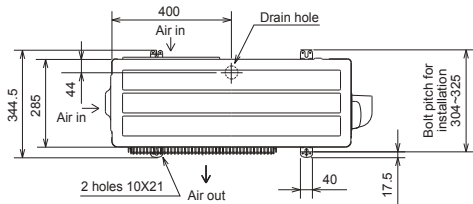

SUZ-KA50VA6 SUZ-KA60VA6 SUZ-KA71VA6

OUTDOOR UNIT

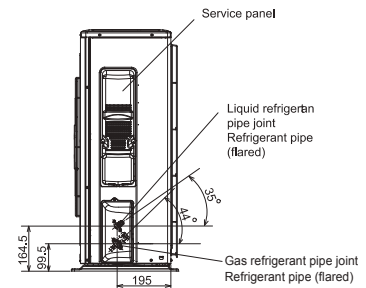
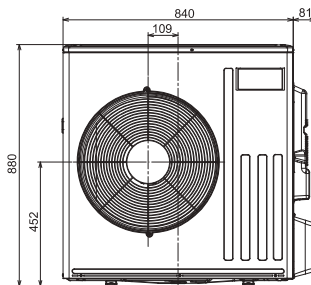
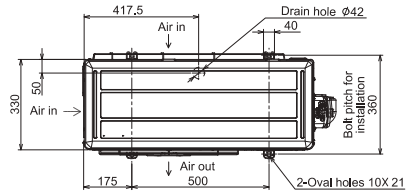

**PEAD-M35JA2 PEAD-M50JA2 PEAD-M60JA2 PEAD-M71JA2
PEAD-M100JA2 PEAD-M125JA2 PEAD-M140JA2**

**PEAD-M35JAL2 PEAD-M50JAL2 PEAD-M60JAL2
PEAD-M71JAL2 PEAD-M100JAL2 PEAD-M125JAL2
PEAD-M140JAL2**

INDOOR UNIT

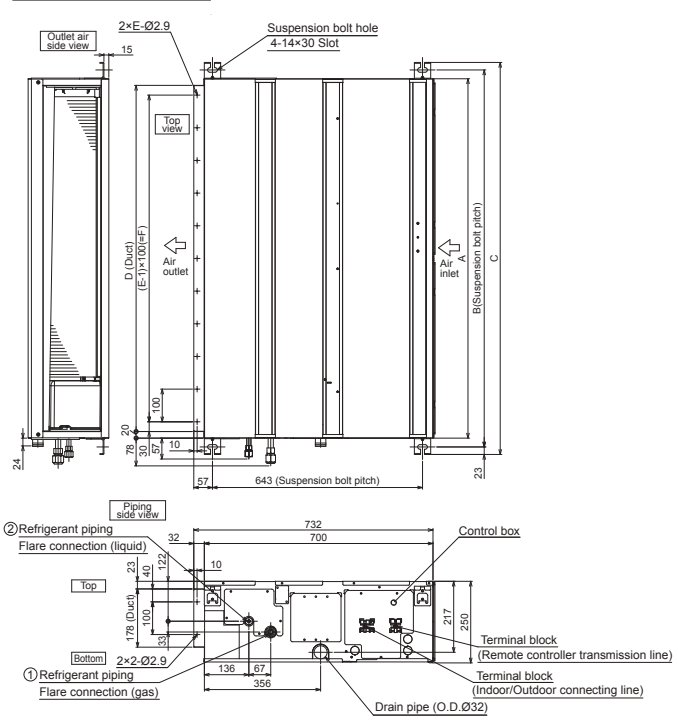
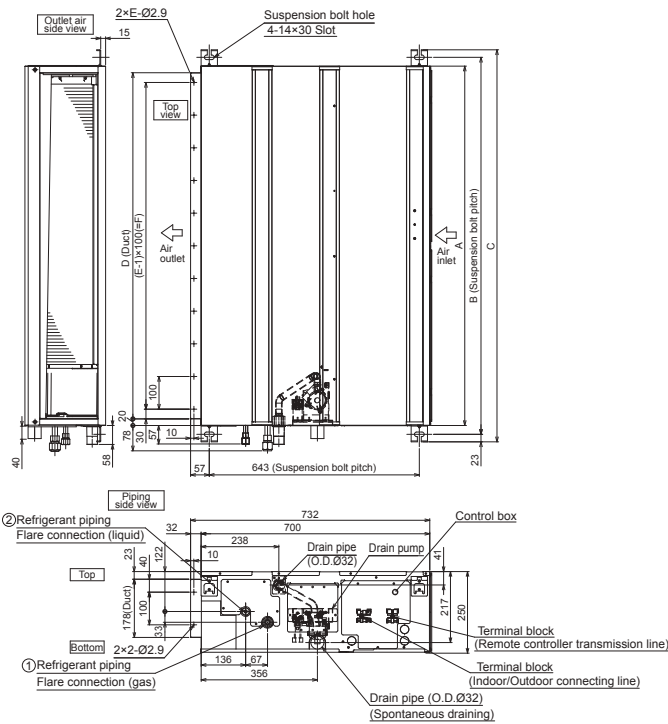

Model	A	B	C	D	E	F	G	① Gas pipe	② Liquid pipe
PEAD-M35, 50JA2	900	954	1000	860	9	800	858	Ø12.7	Ø6.35
PEAD-M60, 71JA2	1100	1154	1200	1060	11	1000	1058		
PEAD-M100, 125JA2	1400	1454	1500	1360	14	1300	1358	Ø15.88	Ø9.52
PEAD-M140JA2	1600	1654	1700	1560	16	1500	1558		

Model	A	B	C	D	E	F	G	① Gas pipe	② Liquid pipe
PEAD-M35, 50JAL2	900	954	1000	860	9	800	858	Ø12.7	Ø6.35
PEAD-M60, 71JAL2	1100	1154	1200	1060	11	1000	1058		
PEAD-M100, 125JAL2	1400	1454	1500	1360	14	1300	1358	Ø15.88	Ø9.52
PEAD-M140JAL2	1600	1654	1700	1560	16	1500	1558		

PEA-M200LA2 PEA-M250LA2

INDOOR UNIT

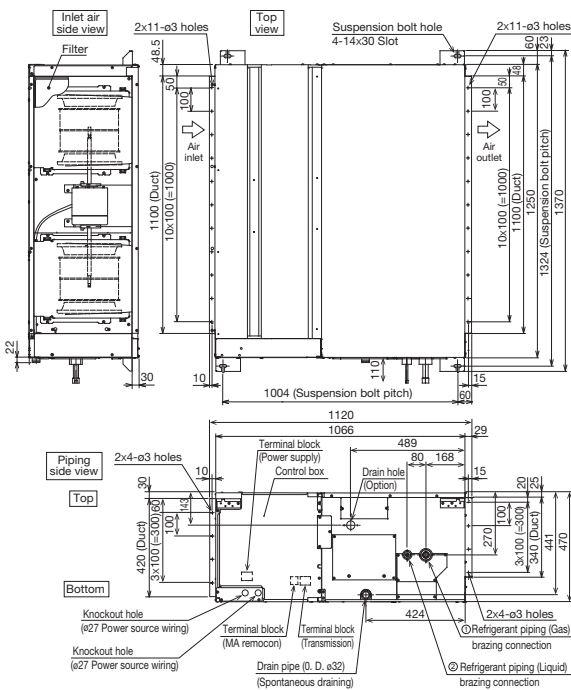

Model	① Gas pipe	② Liquid pipe	Outdoor unit
PEA-M200LA2	ø22.2	ø9.52	PUZ-M200YDA
	ø25.4 ※ Reducer Accessory	ø9.52	PUZ-M200YKA2 PUZ-ZM200YKA2 PUHZ-P200YKA3 PUHZ-ZRP200YKA3
	ø22.2	ø9.52	PUZ-M250YDA
PEA-M250LA2	ø25.4 ※ Reducer Accessory	ø12.7 ※ Reducer Accessory	PUZ-M250YKA2 PUZ-ZM250YKA2 PUHZ-P250YKA3 PUHZ-ZRP250YKA3

PUZ-ZM200YKA2 PUHZ-ZM250YKA2

OUTDOOR UNIT

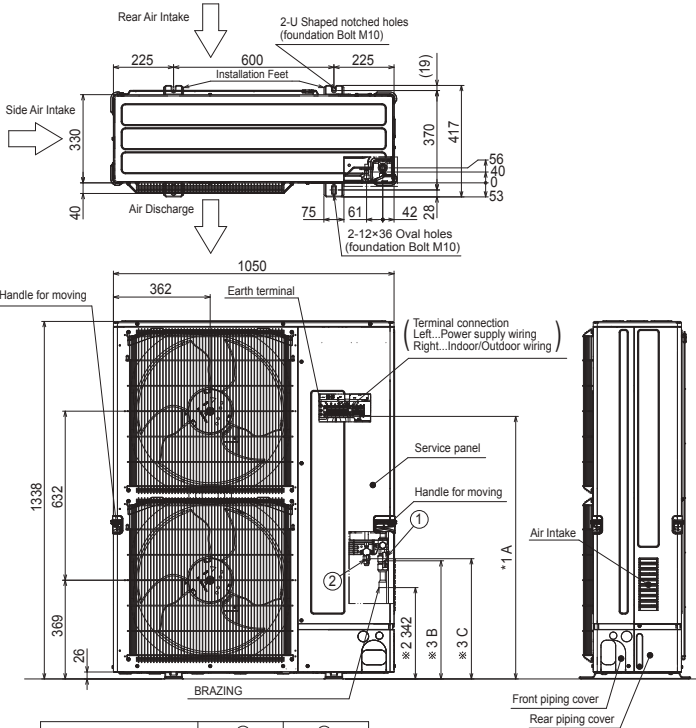

Model	① Refrigerant GAS pipe connection	② Refrigerant LIQUID pipe connection
PUZ-ZMM200YKA.UK	ø19.05 (3/4F)	ø9.52 (3/8F)
PUZ-ZMM250YKA.UK	ø19.05 (3/4F)	ø12.7 (1/2F)

Model	A	B	C	Notes
PUZ-ZMM200,250YKA.UK	985	442	450	*1...Indication of Terminal connection location. *2...Refrigerant GAS PIPE connection (BRAZING) O.Dø25.4. *3...Indication of STOP VALVE connection location.

PUHZ-ZRP200YKA3 PUHZ-ZRP250YKA3

OUTDOOR UNIT

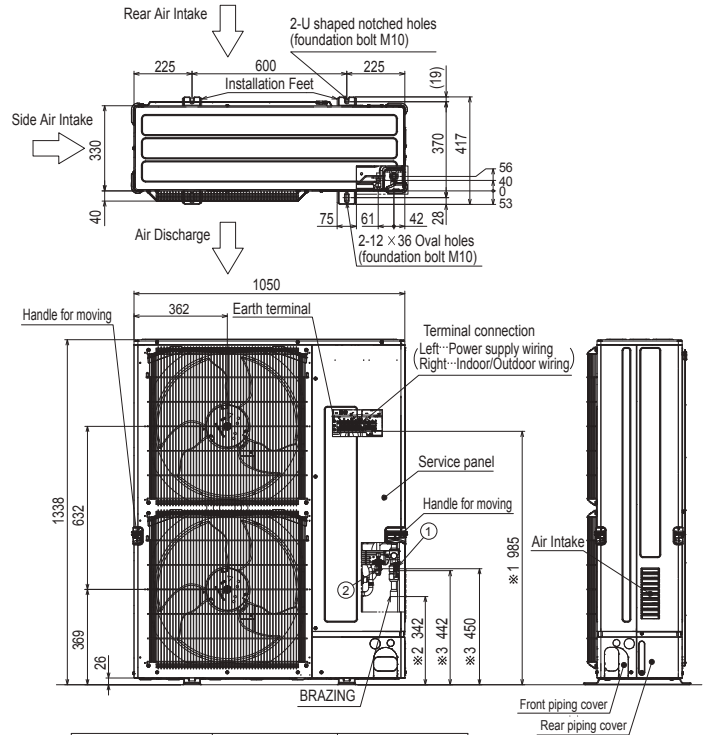

Model	① Refrigerant GAS pipe connection	② Refrigerant LIQUID pipe connection
PUHZ-ZRP200YKA3	ø19.05 (3/4F)	ø9.52 (3/8F)
PUHZ-ZRP250YKA3	ø19.05 (3/4F)	ø12.7 (1/2F)

*1...Indication of Terminal connection location.
*2...Refrigerant GAS pipe connection (BRAZING) O.Dø25.4.
*3...Indication of STOP VALVE connection location.

**PUZ-M100VKA2 PUZ-M100YKA2
PUZ-M125VKA2 PUZ-M125YKA2
PUZ-M140VKA2 PUZ-M140YKA2**

OUTDOOR UNIT

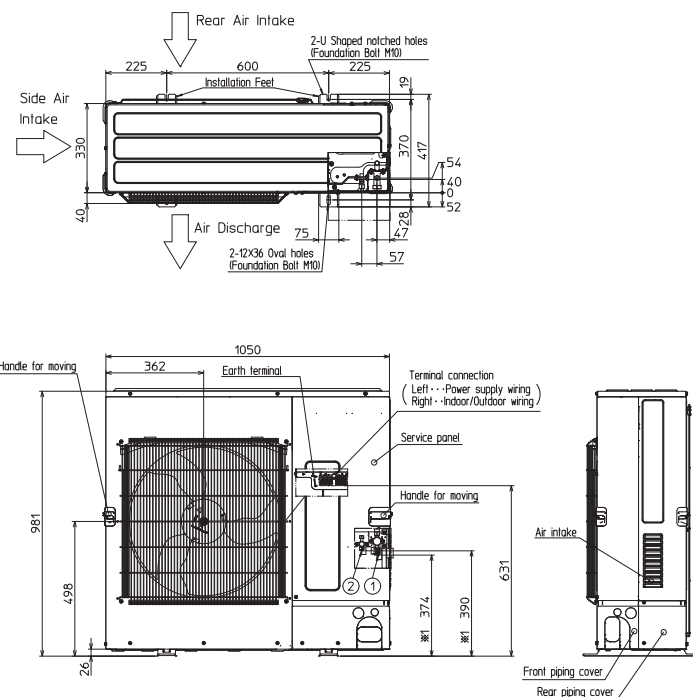

Example Of Notes

- ①...Refrigerant GAS pipe connection (FLARE) ø15.88 (5/8F)
- ②...Refrigerant LIQUID pipe connection (FLARE) ø9.52 (3/8F)
- *1...Indication of STOP VALVE connection location.

**PUHZ-P100VKA PUHZ-P100YKA
PUHZ-P125VKA PUHZ-P125YKA
PUHZ-P140VKA PUHZ-P140YKA**

OUTDOOR UNIT

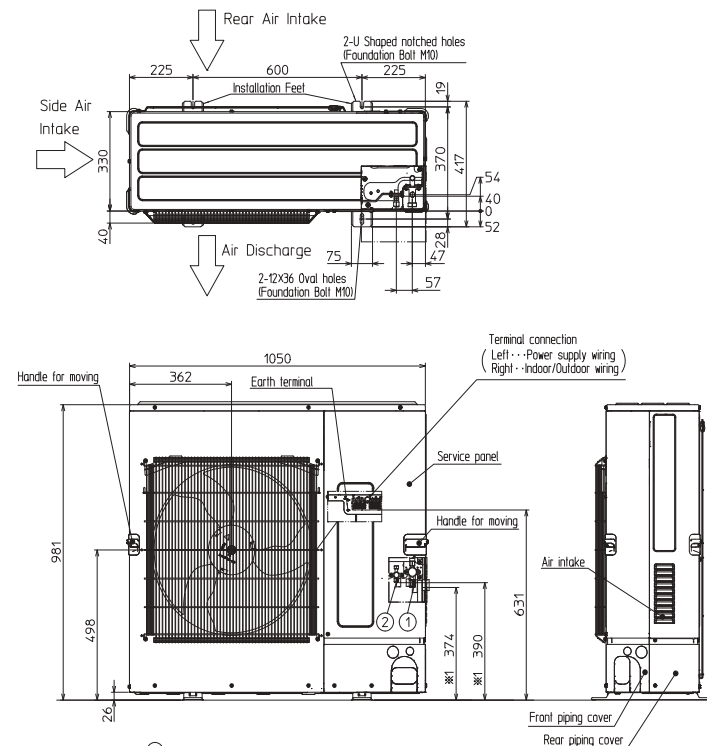

- ①...Refrigerant GAS pipe connection (FLARE) ø15.88 (5/8F)
- ②...Refrigerant LIQUID pipe connection (FLARE) ø9.52 (3/8F)
- *1...Indication of STOP VALVE connection location.

PUZ-M200YKA2 PUZ-M250YKA2

OUTDOOR UNIT

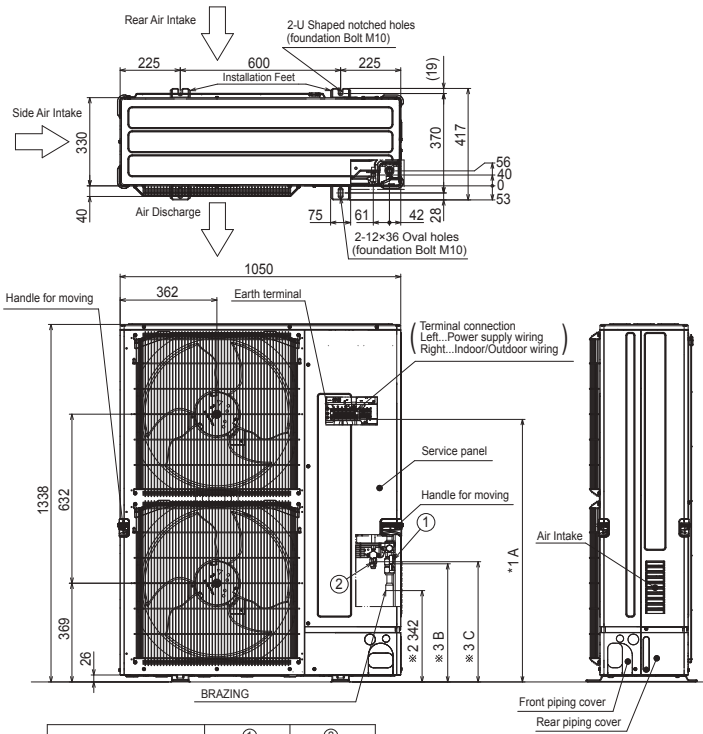

Model	① Refrigerant GAS pipe connection	② Refrigerant LIQUID pipe connection
PUZ-ZM/M200YKA.UK	ø19.05 (3/4F)	ø9.52 (3/8F)
PUZ-ZM/M250YKA.UK	ø19.05 (3/4F)	ø12.7 (1/2F)

Model	A	B	C
PUZ-ZM/M200,250YKA.UK	985	442	450

※ 1...Indication of Terminal connection location.
 ※ 2...Refrigerant GAS PIPE connection (BRAZING) O.Ø25.4.
 ※ 3...Indication of STOP VALVE connection location.

PUHZ-P200YKA3 PUHZ-P250YKA3

OUTDOOR UNIT

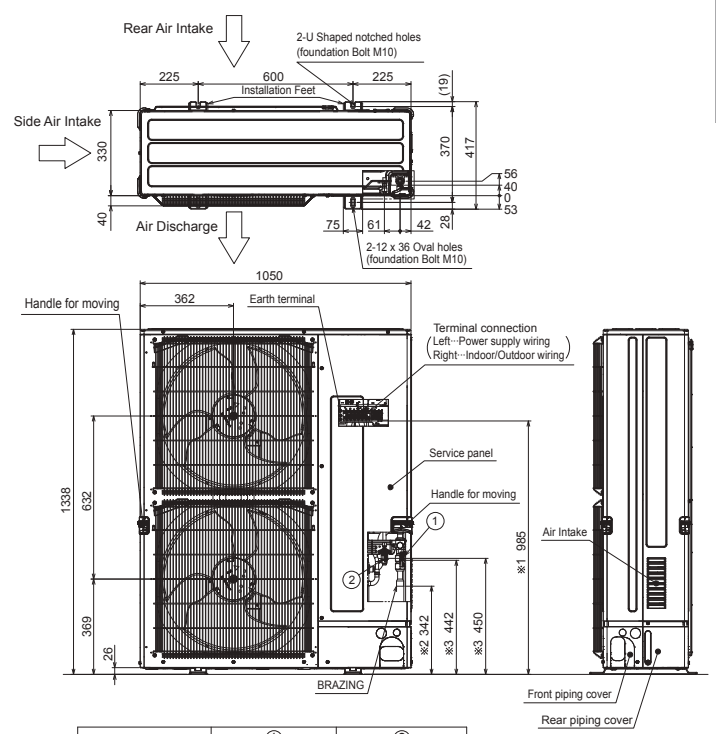

Model	① Refrigerant GAS pipe connection	② Refrigerant LIQUID pipe connection
PUHZ-P200YKA3	ø19.05 (3/4F)	ø9.52 (3/8F)
PUHZ-P250YKA3	ø19.05 (3/4F)	ø12.7 (1/2F)

※ 1--Indication of Terminal connection location.
 ※ 2--Refrigerant GAS pipe connection (BRAZING) O.Ø25.4.
 ※ 3--Indication of STOP VALVE connection location.

PUMY-P112/125/140VKM6(-BS)

PUMY-P112/125/140YKM5(-BS)

OUTDOOR UNIT

OUTDOOR UNIT

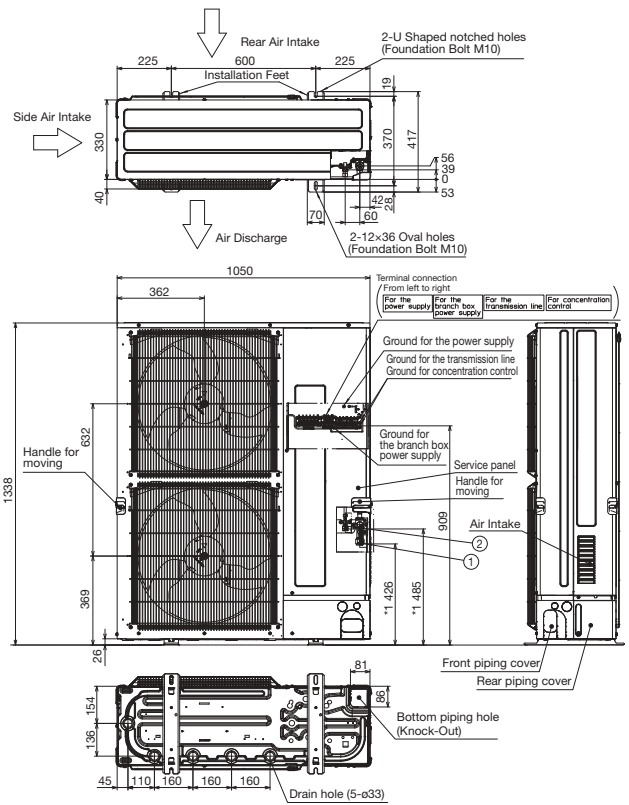
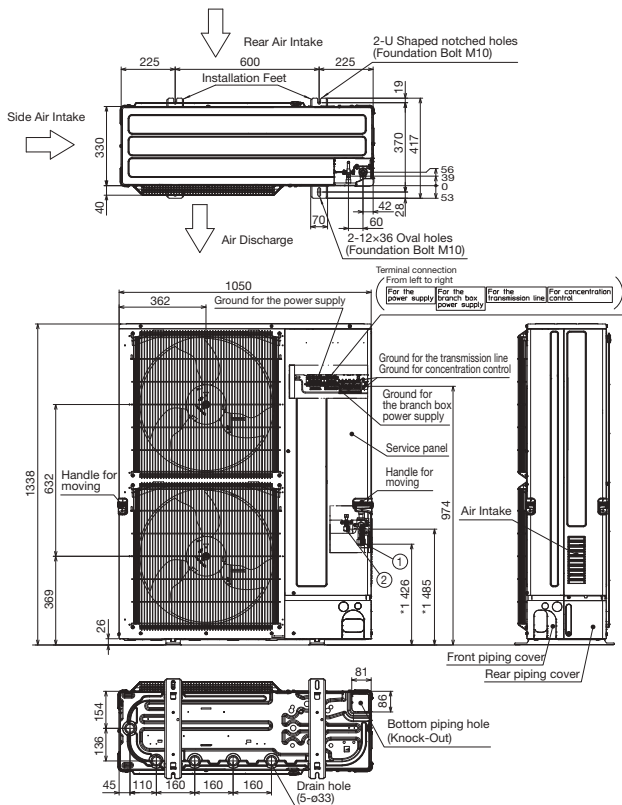

Example of Notes

- ① ---Refrigerant GAS pipe connection (FLARE) φ15.88 (5/8F)
- ② ---Refrigerant LIQUID pipe connection (FLARE) φ9.52 (3/8F)
- *1 ---Indication of STOP VALVE connection location.

Example of Notes

- ① ---Refrigerant GAS pipe connection (FLARE) φ15.88 (5/8F)
- ② ---Refrigerant LIQUID pipe connection (FLARE) φ9.52 (3/8F)
- *1 ---Indication of STOP VALVE connection location.

PUMY-P200YKM3(-BS)

PUMY-SP112/125/140VKM2(-BS)
PUMY-SP112/125/140YKM2(-BS)

OUTDOOR UNIT

OUTDOOR UNIT

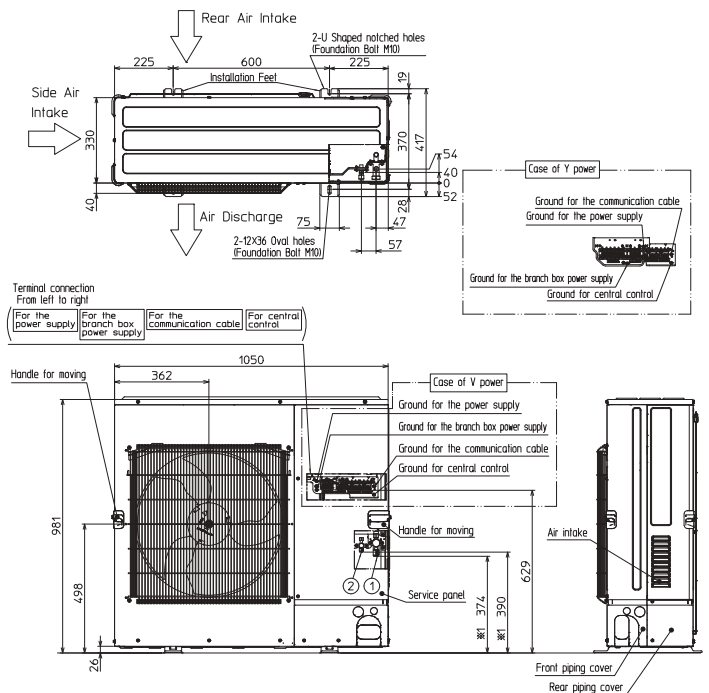
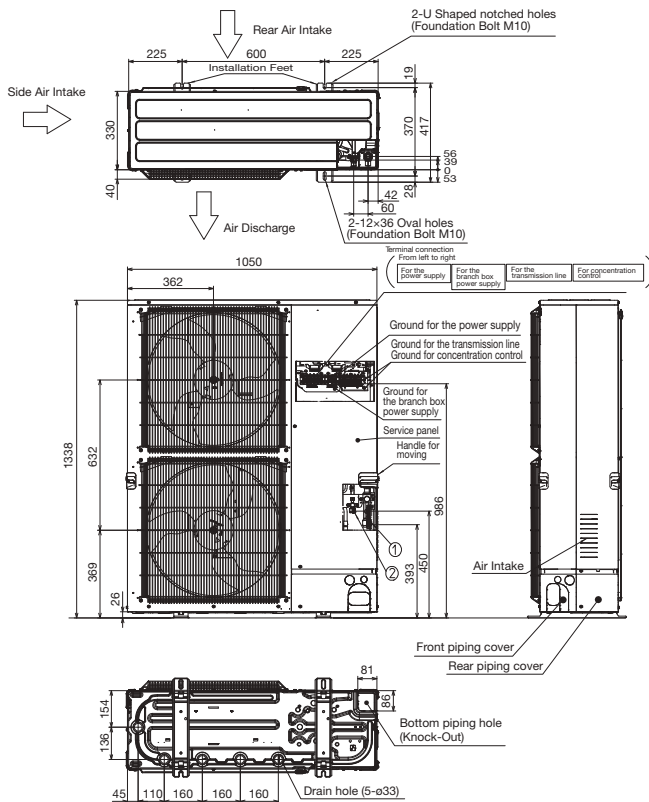

Example of Notes

- ① ---Refrigerant GAS pipe connection (FLARE) φ19.05 (3/4F)
- ② ---Refrigerant LIQUID pipe connection (FLARE) φ9.52 (3/8F)
- *1 ---Indication of STOP VALVE connection location.

Example of Notes

- ① ---Refrigerant GAS pipe connection (FLARE) φ15.88 (5/8F)
- ② ---Refrigerant LIQUID pipe connection (FLARE) φ9.52 (3/8F)
- *1 ---Indication of STOP VALVE connection location.

PAC-MK54BC

Suspension bolt: W3/W8 (M10)

Branch box

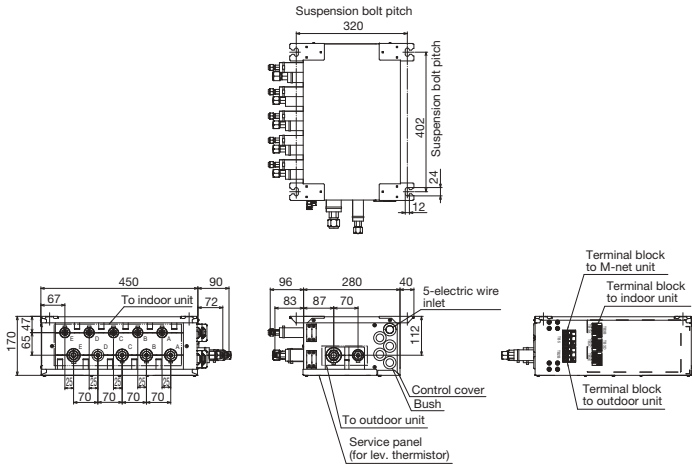

Suspension bolt : W3/8(M10)
Refrigerant pipe flared connection

	A	B	C	D	E	To outdoor unit
Liquid pipe	ø6.35	ø6.35	ø6.35	ø6.35	ø6.35	ø9.52
Gas pipe	ø9.52	ø9.52	ø9.52	ø9.52	ø12.7	ø15.88

PAC-MK34BC

Suspension bolt: W3/W8 (M10)

Branch box

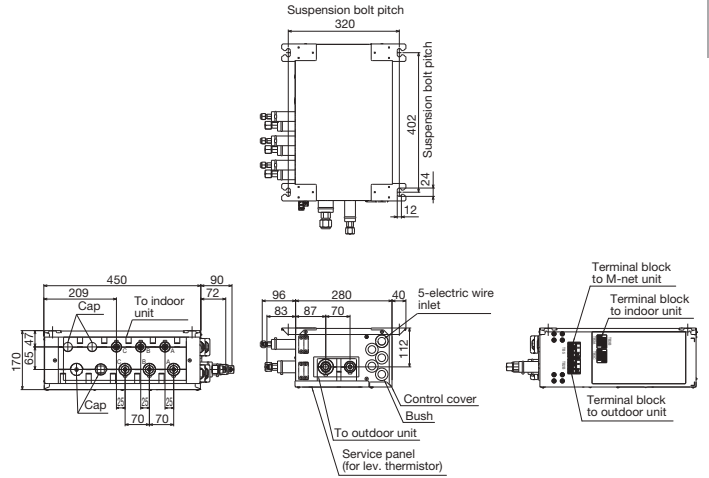

Suspension bolt : W3/8(M10)
Refrigerant pipe flared connection

	A	B	C		To outdoor unit
Liquid pipe	ø6.35	ø6.35	ø6.35		ø9.52
Gas pipe	ø9.52	ø9.52	ø9.52		ø15.88

**PUMY-P250YBM2(-BS)
PUMY-P300YBM2(-BS)**

OUTDOOR UNIT

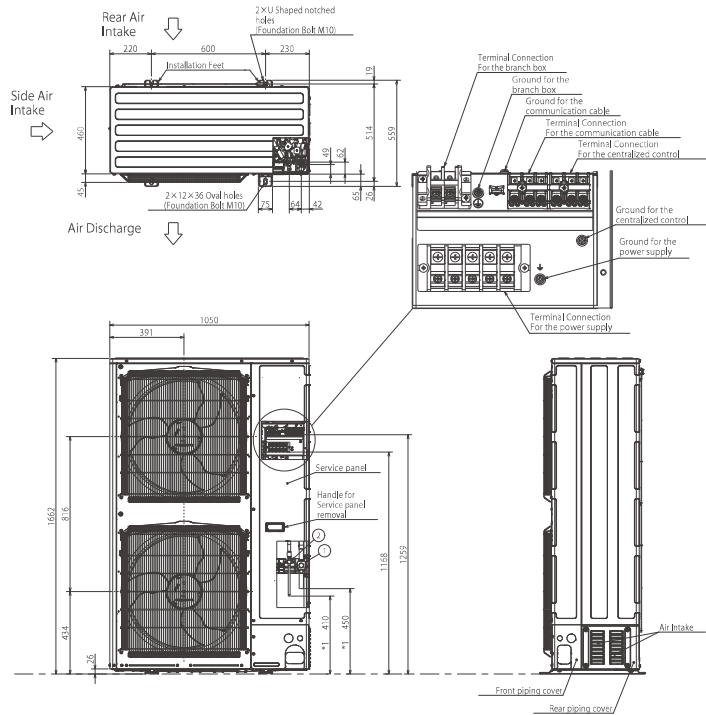

Example of Notes

- ○ ○ Refrigerant GAS pipe connection ø22.2(7/8F)
- ○ ○ Refrigerant LIQ.ID pipe connection ø9.52(3/8F)
- *1 ○ ○ ○ Indication of STOP VALVE and BALL VALVE connection location.

Piping Installation

M SERIES

Single type

Series	Class < Outdoor unit >	Maximum Piping Length (m)		Maximum Height Difference (m)		Maximum Number of Bends	
		Total length (A)	Indoor unit - Distribution pipe B	Outdoor unit - Indoor unit (H)	Indoor unit - Indoor unit h	Total number	
MSZ-RW	25 / 35	20	12			10	
	50	30	15			10	
MSZ-L	25 / 35	20	12			10	
	50	20	12			10	
	60	30	15			10	
MSZ-FT	25	20	12			10	
	35 / 50	30	15			10	
MSZ-A	15 / 25 / 35 / 42 / 50	20	12			10	
	60 / 71	30	15			10	
MSZ-EF	25 / 35 / 42	20	12			10	
	50	30	15			10	
MSZ-BT	20 / 25 / 35 / 50	20	12			10	
MSZ-HR	25 / 35 / 42 / 50	20	12			10	
	60 / 71	30	15			10	
MSY-DW	25 / 35 / 50	20	12			10	
MSY-TP	35 / 50	20	12			10	
MSZ-F MFZ	25 / 35	20	12			10	
	50	30	15			10	
MSZ-S	25 / 35 / 42	20	12			10	
	50 / 60	30	15			10	
MSZ-G	60 / 71	30	15			10	
MSZ-W MSZ-D	25 / 35	20	12			10	
MSZ-HJ	25 / 35 / 50	20	12			10	
	60 / 71	30	15			10	

S SERIES & P SERIES

Single type

Series	Class < Outdoor unit >	Maximum Piping Length (m)		Maximum Height Difference (m)		Maximum Number of Bends	
		Total length (A)	Indoor unit - Distribution pipe B	Outdoor unit - Indoor unit (H)	Indoor unit - Indoor unit h	Total number	
ZUBADAN (PUHZ-SHW)	80 / 112 / 140	75	30			15	
Power Inverter (PUZ-ZM)	35 / 50	50	30			15	
	60 / 71	55	30			15	
	100 / 125 / 140	100	30			15	
Power Inverter (PUHZ-ZRP)	35 / 50 / 60 / 71	50	30			15	
	100 / 125 / 140	75	30			15	
	200 / 250	100	30			15	
Standard Inverter (PUZ-M & SUZ-M)	25 / 35	20	12			10	
	50 / 60 / 71	30	30			10	
	100	55	30			15	
	125 / 140	65				15	
Standard Inverter (PUHZ-P & SUZ-KA)	25 / 35	20	12			10	
	50 / 60 / 71	30	30			10	
	100 / 125 / 140	50	30			15	
	200 / 250	70	30			15	

Twin type

Series	Class < Outdoor unit >	Maximum Piping Length (m)			Maximum Height Difference (m)			Maximum Number of Bends
		Total length A+B+C	Pipe length difference from distribution pipe [B-C]	Indoor unit - Distribution pipe B	Outdoor unit - Indoor unit H	Indoor unit - Indoor unit h	Total number	
ZUBADAN (PUHZ-SHW)	80 / 112 / 140	75	8	20	30	1	15	
Power Inverter (PUZ-ZM)	71	55	8	20	30	1	15	
	100 / 125 / 140	100	8	20	30	1	15	
	200 / 250							
Power Inverter (PUHZ-ZRP)	71	50	8	20	30	1	15	
	100 / 125 / 140	75	8	20	30	1	15	
	200 / 250	100	8	30	30	1	15	
Standard Inverter (PUZ-M)	100	55	8	20	30	1	15	
	125 / 140	65						
	200 / 250							
Standard Inverter (PUHZ-P)	100 / 125 / 140	50	8	20	30	1	15	
	200 / 250	70	8	30	30	1	15	

Triple type

Series	Class < Outdoor unit >	Maximum Piping Length (m)			Maximum Height Difference (m)			Maximum Number of Bends
		Total length A+B+C+D	Pipe length difference from distribution pipe [B-C]	Indoor unit - Distribution pipe B	Outdoor unit - Indoor unit H	Indoor unit - Indoor unit h	Total number	
Power Inverter (PUZ-ZM)	140	100	8	20	30	1	15	
	200 / 250							
Power Inverter (PUHZ-ZRP)	140	75	8	20	30	1	15	
	200 / 250	100	8	30	30	1	15	
Standard Inverter (PUZ-M)	140	65	8	20	30	1	15	
	200 / 250							
Standard Inverter (PUHZ-P)	140	50	8	20	30	1	15	
	200 / 250	70	8	28	30	1	15	

Quadruple type

Series	Class < Outdoor unit >	Maximum Piping Length (m)			Maximum Height Difference (m)			Maximum Number of Bends
		Total length A+B+C+D+E	Pipe length difference from distribution pipe [B-C]	Indoor unit - Distribution pipe B	Outdoor unit - Indoor unit H	Indoor unit - Indoor unit h	Total number	
Power Inverter (PUZ-ZM, PUHZ-ZRP)	200 / 250	100	8	30	30	1	15	
Standard Inverter (PUZ-M, PUHZ-P)	200 / 250	70	8	22	30	1	15	

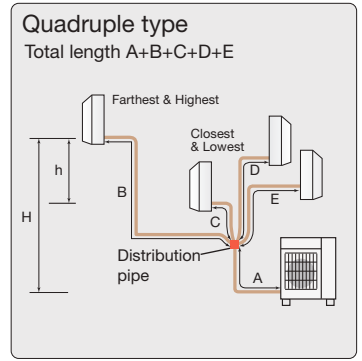
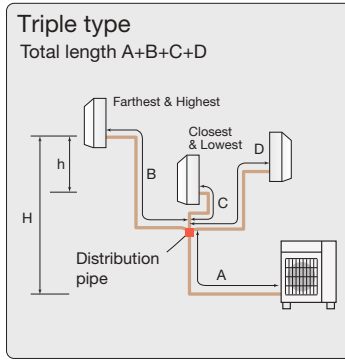
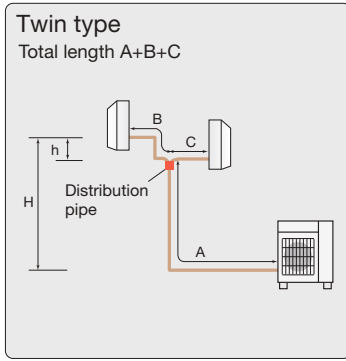
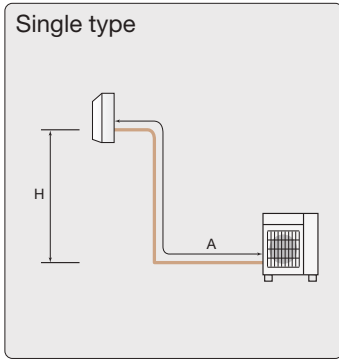

MXZ SERIES

MXZ-2D33VA, MXZ-2F33VF4

Maximum Piping Length	
Outdoor unit - Indoor unit (a,b)	15m
Total length (a+b)	20m

Maximum Number of Bends	
Outdoor unit - Indoor unit (a,b)	15
Total number (a+b)	20

* When connecting MFZ-KJ Series indoor unit, additional refrigerant is required. For details, please contact Mitsubishi Electric.

Regarding MXZ-2D33, the second unit should be a different type in the case of selecting one MFZ-KJ.

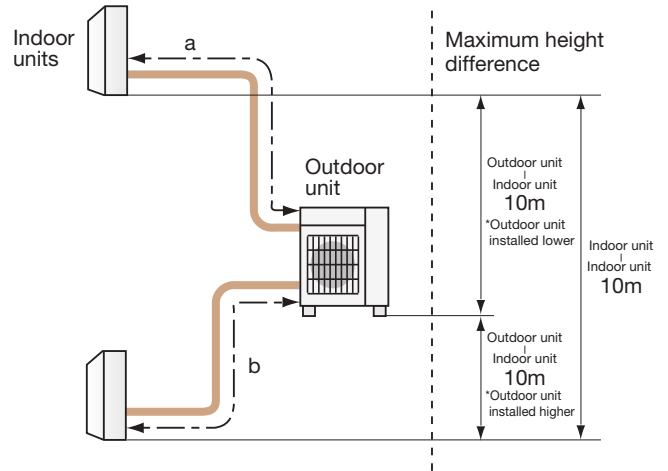

MXZ-2D42VA2, MXZ-2F42VF4

Maximum Piping Length	
Outdoor unit - Indoor unit (a,b)	20m
Total length (a+b)	30m

Maximum Number of Bends	
Outdoor unit - Indoor unit (a,b)	20
Total number (a+b)	30

MXZ-2D53VA(H)2, MXZ-2E53VAHZ, MXZ-2F53VF(H)4

Maximum Piping Length	
Outdoor unit - Indoor unit (a,b)	20m
Total length (a+b)	30m

Maximum Number of Bends	
Outdoor unit - Indoor unit (a,b)	20
Total number (a+b)	30

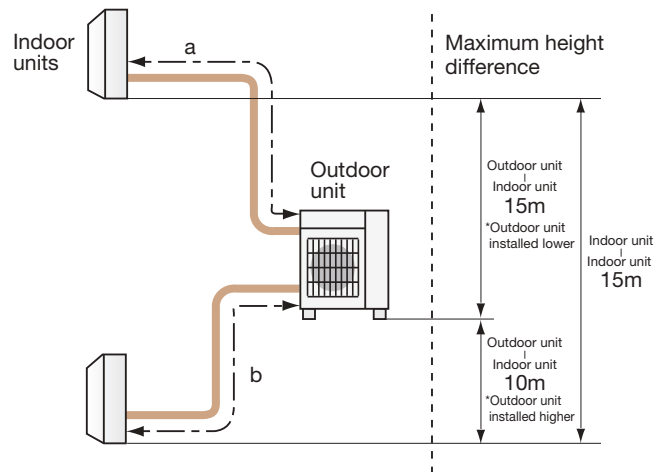

* When connecting MFZ-KJ Series indoor unit to MXZ-2D42VA2 or MXZ-2D53VA(H)2, additional refrigerant is required. For details, please contact Mitsubishi Electric.

MXZ SERIES

MXZ-2DM40VA, MXZ-2HA40VF2, MXZ-2HA50VF2

Maximum Piping Length	
Outdoor unit - Indoor unit (a,b)	20m
Total length (a+b)	30m

Maximum Number of Bends	
Outdoor unit - Indoor unit (a,b)	20
Total number (a+b)	30

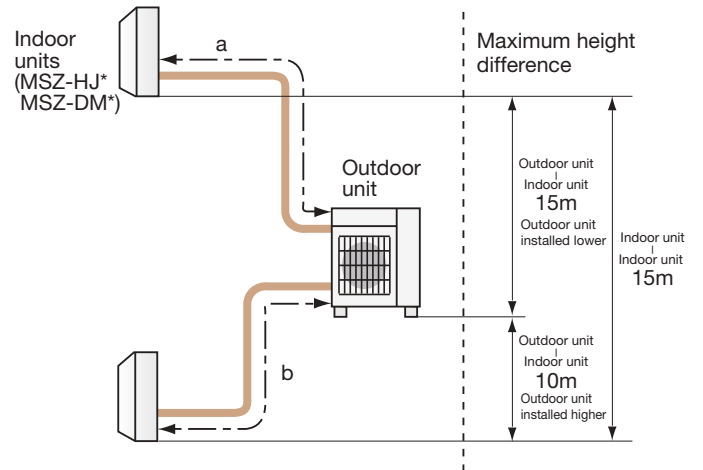

* Only MSZ-HJ and DM model is connectable.

MXZ-3DM50VA, MXZ-3HA50VF2

Maximum Piping Length	
Outdoor unit - Indoor unit (a,b,c)	25m
Total length (a+b+c)	50m

Maximum Number of Bends	
Outdoor unit - Indoor unit (a,b,c)	25
Total number (a+b+c)	50

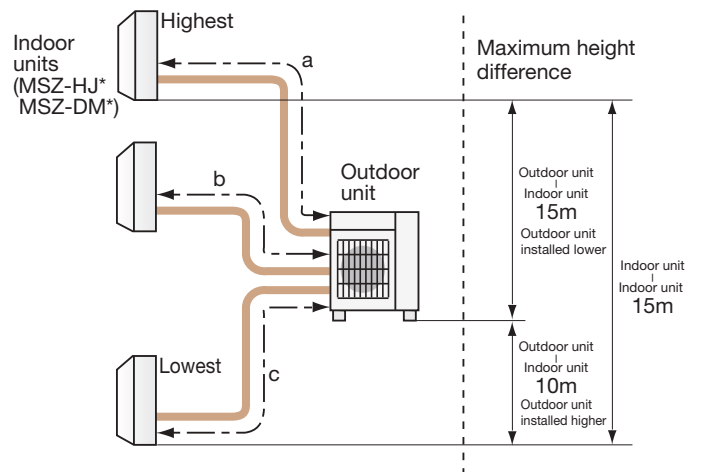

* Only MSZ-HJ and DM model is connectable.

MXZ-3E54VA, MXZ-3F54VF4

Maximum Piping Length	
Outdoor unit - Indoor unit (a,b,c,d)	25m
Total length (a+b+c+d)	50m

Maximum Number of Bends	
Outdoor unit - Indoor unit (a,b,c,d)	25
Total number (a+b+c+d)	50

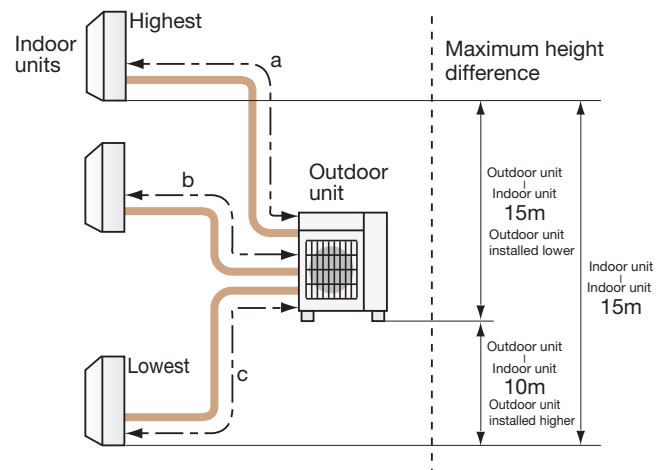

MXZ-4E72VA, MXZ-3F68VF4, MXZ-4F72VF4, MXZ-4F80VF4

Maximum Piping Length	
Outdoor unit - Indoor unit (a,b,c,d)	25m
Total length (a+b+c+d)	60m

Maximum Number of Bends	
Outdoor unit - Indoor unit (a,b,c,d)	25
Total number (a+b+c+d)	60

* When connecting MFZ-KJ Series indoor unit, additional refrigerant is required. For details, please contact Mitsubishi Electric.

MXZ-4E83VA, MXZ-4E83VAHZ, MXZ-4F83VF2

Maximum Piping Length	
Outdoor unit - Indoor unit (a,b,c,d)	25m
Total length (a+b+c+d)	70m

Maximum Number of Bends	
Outdoor unit - Indoor unit (a,b,c,d)	25
Total number (a+b+c+d)	70

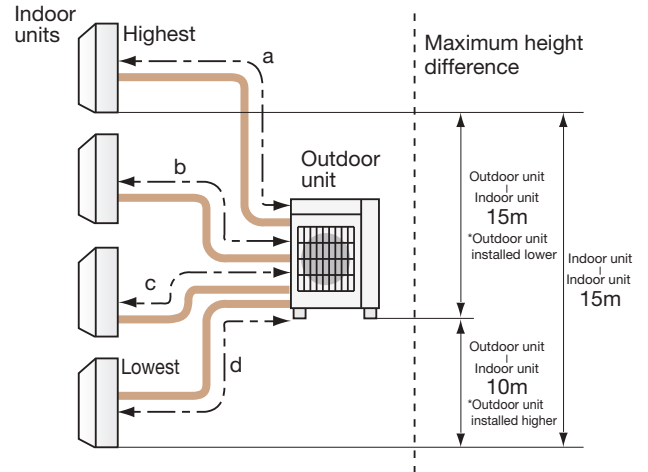

MXZ-5E102VA, MXZ-5F102VF2

Maximum Piping Length	
Outdoor unit - Indoor unit (a,b,c,d,e)	25m
Total length (a+b+c+d+e)	80m

Maximum Number of Bends	
Outdoor unit - Indoor unit (a,b,c,d,e)	25
Total number (a+b+c+d+e)	80

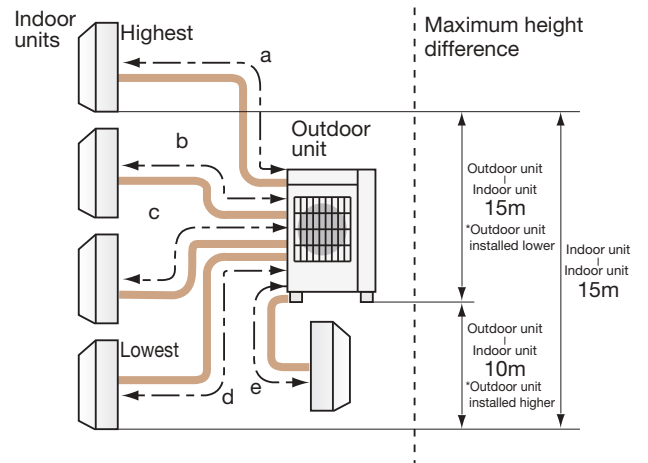

MXZ-6D122VA2, MXZ-6F120VF2

Maximum Piping Length	
Outdoor unit - Indoor unit (a,b,c,d,e,f)	25m
Total length (a+b+c+d+e+f)	80m

Maximum Number of Bends	
Outdoor unit - Indoor unit (a,b,c,d,e,f)	25
Total number (a+b+c+d+e+f)	80

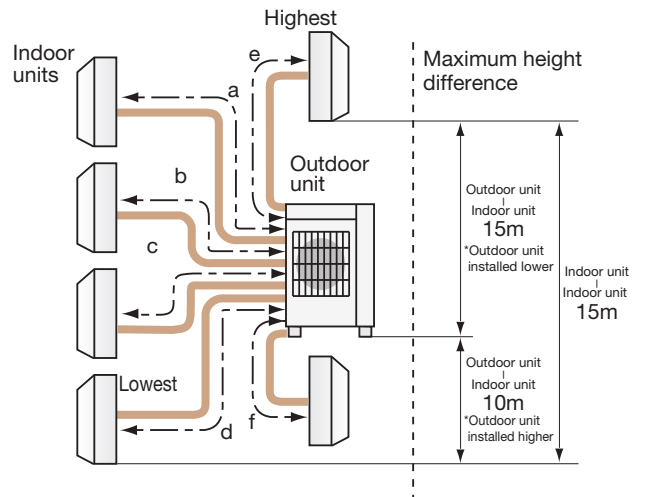

PUMY SERIES

PUMY-SP112/125/140V(Y)KM2

1-Branch box

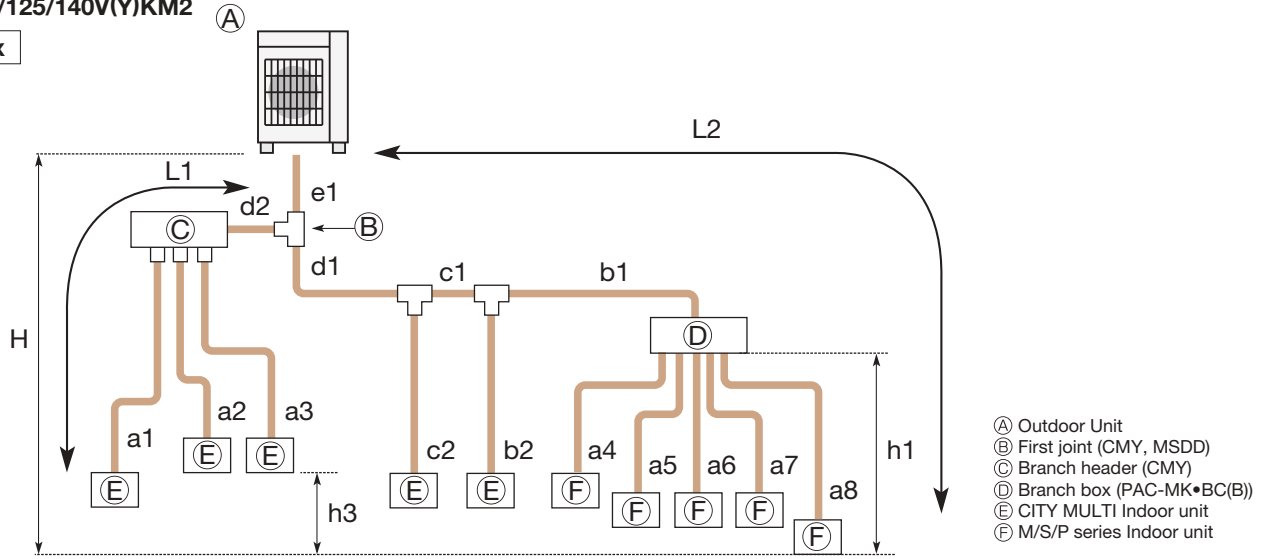

Permissible length (One-way)	Total piping length	$e1 + d1 + d2 + c1 + c2 + b1 + b2 + a1 + a2 + a3 + a4 + a5 + a6 + a7 + a8 \leq 120 \text{ m}$
	Farthest piping length (L1)	$e1 + d2 + a1$ or $e1 + d1 + c1 + b2 \leq 70 \text{ m}$
	Farthest piping length. Via Branch box (L2)	$e1 + d1 + c1 + b1 + a8 \leq 80 \text{ m}$
	Piping length between outdoor unit and branch box	$e1 + d1 + c1 + b1 \leq 55 \text{ m}$
	Farthest piping length from the first joint	$d1 + c1 + b1$ or $d1 + c1 + b2 \leq 50 \text{ m}$
	Farthest piping length after branch box	$a8 \leq 25 \text{ m}$
	Total piping length between branch boxes and indoor units	$a4 + a5 + a6 + a7 + a8 \leq 95 \text{ m}$
Permissible height difference (One-way)	In indoor/outdoor section (H)*1	$H \leq 50 \text{ m}$ (In case of outdoor unit is set higher than indoor unit) $H \leq 30 \text{ m}$ (In case of outdoor unit is set lower than indoor unit)
	In branch box/indoor unit section (h1)	$h1 \leq 15 \text{ m}$
	In each indoor unit (h3)	$h3 \leq 12 \text{ m}$
Number of bends		$ e1 + d2 + a1 , e1 + d2 + a2 , e1 + d2 + a3 , e1 + d1 + c2 , e1 + d1 + c1 + b2 , e1 + d1 + c1 + b1 + a4 , e1 + d1 + c1 + b1 + a5 , e1 + d1 + c1 + b1 + a6 , e1 + d1 + c1 + b1 + a7 , e1 + d1 + c1 + b1 + a8 \leq 15$

*1: Branch box should be placed within the level between the outdoor unit and indoor units.

2-Branch boxes

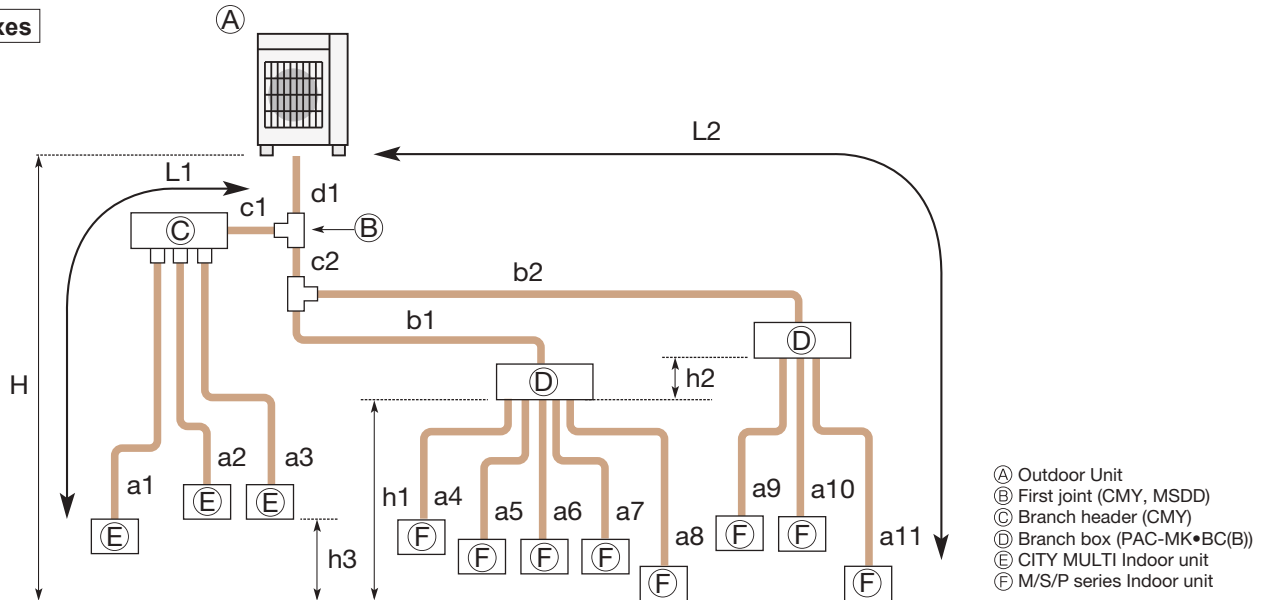

Permissible length (One-way)	Total piping length	$d1 + c1 + c2 + b1 + b2 + a1 + a2 + a3 + a4 + a5 + a6 + a7 + a8 + a9 + a10 + a11 \leq 120 \text{ m}$
	Farthest piping length (L1)	$d1 + c1 + a1 \leq 70 \text{ m}$
	Farthest piping length. Via Branch box (L2)	$d1 + c2 + b2 + a11 \leq 80 \text{ m}$
	Piping length between outdoor unit and branch boxes	$d1 + c2 + b1 + b2 \leq 55 \text{ m}$
	Farthest piping length from the first joint	$c2 + b2$ or $c1 + a1 \leq 50 \text{ m}$
	Farthest piping length after branch box	$a11 \leq 25 \text{ m}$
	Farthest branch box from outdoor unit	$d1 + c2 + b2 \leq 55 \text{ m}$
Total piping length between branch boxes and indoor units	$a4 + a5 + a6 + a7 + a8 + a9 + a10 + a11 \leq 95 \text{ m}$	
Permissible height difference (One-way)	In indoor/outdoor section (H)*1	$H \leq 50 \text{ m}$ (In case of outdoor unit is set higher than indoor unit) $H \leq 30 \text{ m}$ (In case of outdoor unit is set lower than indoor unit)
	In branch box/indoor unit section (h1)	$h1 + h2 \leq 15 \text{ m}$
	In each branch unit (h2)	$h2 \leq 15 \text{ m}$
	In each indoor unit (h3)	$h3 \leq 12 \text{ m}$
Number of bends		$ d1 + c1 + a1 , d1 + c1 + a2 , d1 + c1 + a3 , d1 + c2 + b1 + a4 , d1 + c2 + b1 + a5 , d1 + c2 + b1 + a6 , d1 + c2 + b1 + a7 , d1 + c2 + b1 + a8 , d1 + c2 + b2 + a9 , d1 + c2 + b2 + a10 , d1 + c2 + b2 + a11 \leq 15$

*1: Branch box should be placed within the level between the outdoor unit and indoor units.

PUMY-P112/125/140VKM6
PUMY-P112/125/140YKM5

1-Branch box

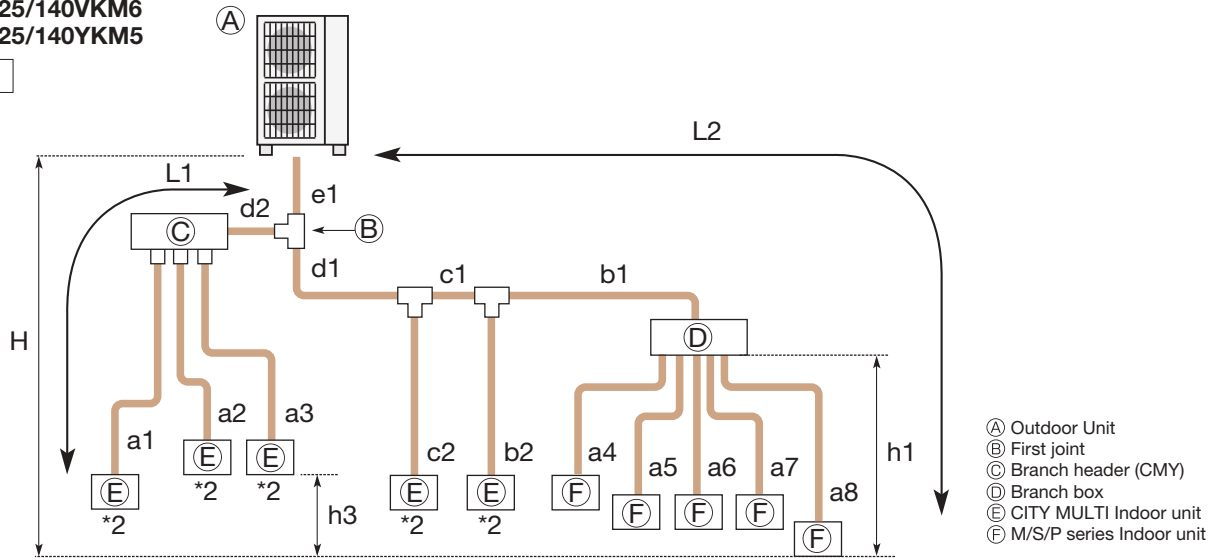

- Ⓐ Outdoor Unit
- Ⓑ First joint
- Ⓒ Branch header (CMY)
- Ⓓ Branch box
- Ⓔ CITY MULTI Indoor unit
- Ⓕ M/S/P series Indoor unit

Permissible length (One-way)	Total piping length	$e1 + d1 + d2 + c1 + c2 + b1 + b2 + a1 + a2 + a3 + a4 + a5 + a6 + a7 + a8 \leq 300 \text{ m}$
	Farthest piping length (L1)	$e1 + d2 + a1 \text{ or } e1 + d1 + c1 + b2 \leq 85 \text{ m}$
	Farthest piping length. Via Branch box (L2)	$e1 + d1 + c1 + b1 + a8 \leq 80 \text{ m}$
	Piping length between outdoor unit and branch box	$e1 + d1 + c1 + b1 \leq 55 \text{ m}$
	Farthest piping length from the first joint	$d1 + c1 + b1 \text{ or } d1 + c1 + b2 \leq 30 \text{ m}$
	Farthest piping length after branch box	$a8 \leq 25 \text{ m}$
Permissible height difference (One-way)	Total piping length between branch boxes and indoor units	$a4 + a5 + a6 + a7 + a8 \leq 95 \text{ m}$
	In indoor/outdoor section (H)*1	$H \leq 50 \text{ m}$ (In case of outdoor unit is set higher than indoor unit) $H \leq 40 \text{ m}$ (In case of outdoor unit is set lower than indoor unit)
	In branch box/indoor unit section (h1)	$h1 \leq 15 \text{ m}$
	In each indoor unit (h3)	$h3 \leq 12 \text{ m}$
Number of bends		$ e1 + d2 + a1 , e1 + d2 + a2 , e1 + d2 + a3 , e1 + d1 + c2 , e1 + d1 + c1 + b2 , e1 + d1 + c1 + b1 + a4 , e1 + d1 + c1 + b1 + a5 , e1 + d1 + c1 + b1 + a6 , e1 + d1 + c1 + b1 + a7 , e1 + d1 + c1 + b1 + a8 \leq 15$

*1: Branch box should be placed within the level between the outdoor unit and indoor units.

2: PKFY-P-VBM, PKFY-P10-32VLM, PFFY-P-VKM, PFFY-P-VCM, and PFFY-P-VL type indoor units cannot be used in a mixed system.

2-Branch boxes

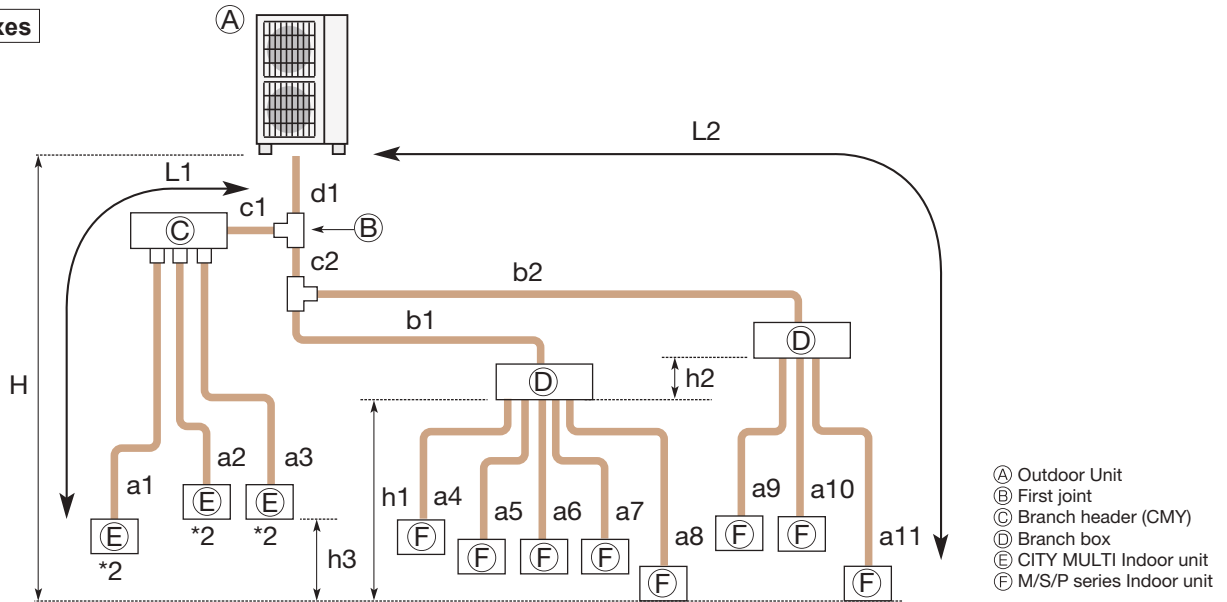

- Ⓐ Outdoor Unit
- Ⓑ First joint
- Ⓒ Branch header (CMY)
- Ⓓ Branch box
- Ⓔ CITY MULTI Indoor unit
- Ⓕ M/S/P series Indoor unit

Permissible length (One-way)	Total piping length	$d1 + c1 + c2 + b1 + b2 + a1 + a2 + a3 + a4 + a5 + a6 + a7 + a8 + a9 + a10 + a11 \leq 240 \text{ m}$
	Farthest piping length (L1)	$d1 + c1 + a1 \leq 85 \text{ m}$
	Farthest piping length. Via Branch box (L2)	$d1 + c2 + b2 + a11 \leq 80 \text{ m}$
	Piping length between outdoor unit and branch boxes	$d1 + c2 + b1 + b2 \leq 55 \text{ m}$
	Farthest piping length from the first joint	$c2 + b2 \text{ or } c1 + a1 \leq 30 \text{ m}$
	Farthest piping length after branch box	$a11 \leq 25 \text{ m}$
Permissible height difference (One-way)	Farthest branch box from outdoor unit	$d1 + c2 + b2 \leq 55 \text{ m}$
	Total piping length between branch boxes and indoor units	$a4 + a5 + a6 + a7 + a8 + a9 + a10 + a11 \leq 95 \text{ m}$
	In indoor/outdoor section (H)*1	$H \leq 50 \text{ m}$ (In case of outdoor unit is set higher than indoor unit) $H \leq 40 \text{ m}$ (In case of outdoor unit is set lower than indoor unit)
	In branch box/indoor unit section (h1)	$h1 + h2 \leq 15 \text{ m}$
Number of bends	In each branch unit (h2)	$h2 \leq 15 \text{ m}$
	In each indoor unit (h3)	$h3 \leq 12 \text{ m}$
Number of bends		$ d1 + c1 + a1 , d1 + c1 + a2 , d1 + c1 + a3 , d1 + c2 + b1 + a4 , d1 + c2 + b1 + a5 , d1 + c2 + b1 + a6 , d1 + c2 + b1 + a7 , d1 + c2 + b1 + a8 , d1 + c2 + b2 + a9 , d1 + c2 + b2 + a10 , d1 + c2 + b2 + a11 \leq 15$

*1: Branch box should be placed within the level between the outdoor unit and indoor units.

2: PKFY-P-VBM, PKFY-P10-32VLM, PFFY-P-VKM, PFFY-P-VCM, and PFFY-P-VL type indoor units cannot be used in a mixed system.

PUMY-P200YKM3(-BS)

1-Branch box

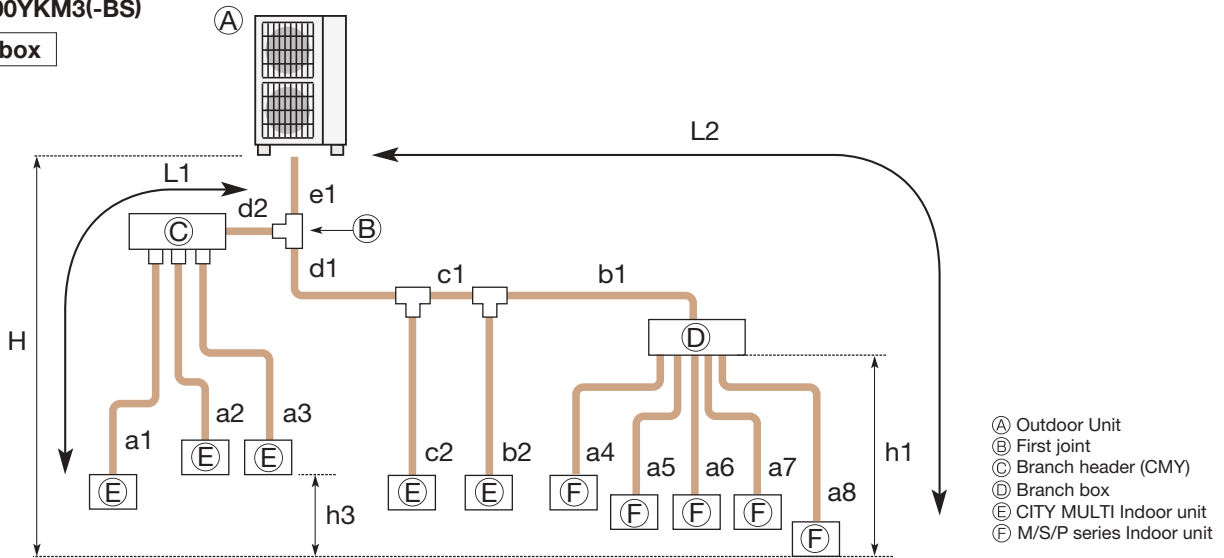

- Ⓐ Outdoor Unit
- Ⓑ First joint
- Ⓒ Branch header (CMY)
- Ⓓ Branch box
- Ⓔ CITY MULTI Indoor unit
- Ⓕ M/S/P series Indoor unit

Permissible length (One-way)	Total piping length	$e1 + d1 + d2 + c1 + c2 + b1 + b2 + a1 + a2 + a3 + a4 + a5 + a6 + a7 + a8 \leq 150 \text{ m}$
	Farthest piping length (L1)	$e1 + d2 + a1 \text{ or } e1 + d1 + c1 + b2 \leq 80 \text{ m}$
	Farthest piping length. Via Branch box (L2)	$e1 + d1 + c1 + b1 + a8 \leq 80 \text{ m}$
	Piping length between outdoor unit and branch box	$e1 + d1 + c1 + b1 \leq 55 \text{ m}$
	Farthest piping length from the first joint	$d1 + c1 + b1 \text{ or } d1 + c1 + b2 \leq 30 \text{ m}$
	Farthest piping length after branch box	$a8 \leq 25 \text{ m}$
	Total piping length between branch boxes and indoor units	$a4 + a5 + a6 + a7 + a8 \leq 95 \text{ m}$
Permissible height difference (One-way)	In indoor/outdoor section (H)*1	$H \leq 50 \text{ m}$ (In case of outdoor unit is set higher than indoor unit) $H \leq 40 \text{ m}$ (In case of outdoor unit is set lower than indoor unit)
	In branch box/indoor unit section (h1)	$h1 \leq 15 \text{ m}$
	In each indoor unit (h3)	$h3 \leq 12 \text{ m}$
Number of bends		$ e1 + d2 + a1 , e1 + d2 + a2 , e1 + d2 + a3 , e1 + d1 + c2 , e1 + d1 + c1 + b2 , e1 + d1 + c1 + b1 + a4 , e1 + d1 + c1 + b1 + a5 , e1 + d1 + c1 + b1 + a6 , e1 + d1 + c1 + b1 + a7 , e1 + d1 + c1 + b1 + a8 \leq 15$

*1: Branch box should be placed within the level between the outdoor unit and indoor units.

2-Branch boxes

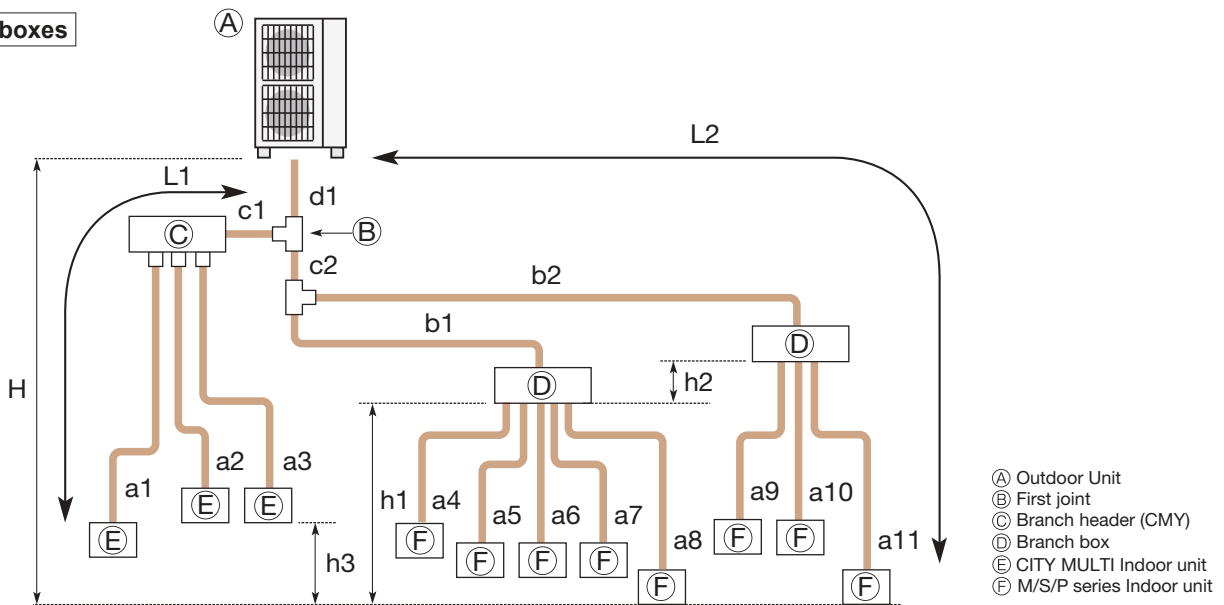

- Ⓐ Outdoor Unit
- Ⓑ First joint
- Ⓒ Branch header (CMY)
- Ⓓ Branch box
- Ⓔ CITY MULTI Indoor unit
- Ⓕ M/S/P series Indoor unit

Permissible length (One-way)	Total piping length	$d1 + c1 + c2 + b1 + b2 + a1 + a2 + a3 + a4 + a5 + a6 + a7 + a8 + a9 + a10 + a11 \leq 150 \text{ m}$
	Farthest piping length (L1)	$d1 + c1 + a1 \leq 80 \text{ m}$
	Farthest piping length. Via Branch box (L2)	$d1 + c2 + b2 + a11 \leq 80 \text{ m}$
	Piping length between outdoor unit and branch boxes	$d1 + c2 + b1 + b2 \leq 55 \text{ m}$
	Farthest piping length from the first joint	$c2 + b2 \text{ or } c1 + a1 \leq 30 \text{ m}$
	Farthest piping length after branch box	$a11 \leq 25 \text{ m}$
	Farthest branch box from outdoor unit	$d1 + c2 + b2 \leq 55 \text{ m}$
	Total piping length between branch boxes and indoor units	$a4 + a5 + a6 + a7 + a8 + a9 + a10 + a11 \leq 95 \text{ m}$
Permissible height difference (One-way)	In indoor/outdoor section (H)*1	$H \leq 50 \text{ m}$ (In case of outdoor unit is set higher than indoor unit) $H \leq 40 \text{ m}$ (In case of outdoor unit is set lower than indoor unit)
	In branch box/indoor unit section (h1)	$h1 + h2 \leq 15 \text{ m}$
	In each branch unit (h2)	$h2 \leq 15 \text{ m}$
	In each indoor unit (h3)	$h3 \leq 12 \text{ m}$
Number of bends		$ d1 + c1 + a1 , d1 + c1 + a2 , d1 + c1 + a3 , d1 + c2 + b1 + a4 , d1 + c2 + b1 + a5 , d1 + c2 + b1 + a6 , d1 + c2 + b1 + a7 , d1 + c2 + b1 + a8 , d1 + c2 + b2 + a9 , d1 + c2 + b2 + a10 , d1 + c2 + b2 + a11 \leq 15$

*1: Branch box should be placed within the level between the outdoor unit and indoor units.

PUMY-P250/300YBM2(-BS)

1-Branch box

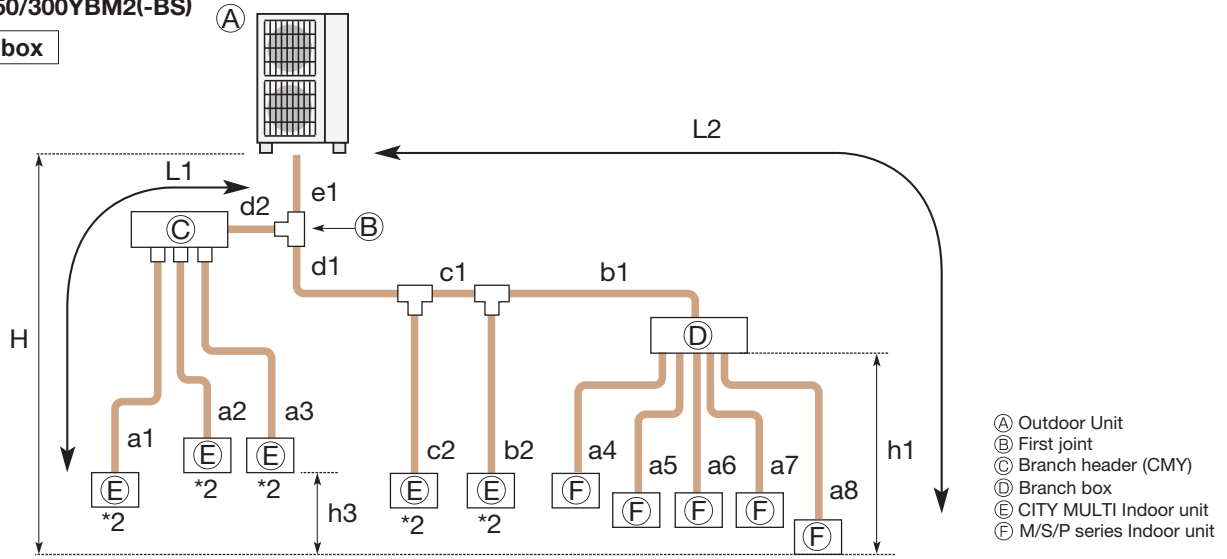

Permissible length (One-way)	Total piping length	$e1 + d1 + d2 + c1 + c2 + b1 + b2 + a1 + a2 + a3 + a4 + a5 + a6 + a7 + a8 \leq 310$ m
	Farthest piping length (L1)	$e1 + d2 + a1$ or $e1 + d1 + c1 + b2 \leq 85$ m
	Farthest piping length. Via Branch box (L2)	$e1 + d1 + c1 + b1 + a8 \leq 80$ m
	Piping length between outdoor unit and branch box	$e1 + d1 + c1 + b1 \leq 80$ m
	Farthest piping length from the first joint	$d1 + c1 + b1$ or $d1 + c1 + b2 \leq 30$ m
	Farthest piping length after branch box	$a8 \leq 25$ m
Permissible height difference (One-way)	Total piping length between branch boxes and indoor units	$a4 + a5 + a6 + a7 + a8 \leq 145$ m
	In indoor/outdoor section (H)*1	$H \leq 50$ m (In case of outdoor unit is set higher than indoor unit) $H \leq 40$ m (In case of outdoor unit is set lower than indoor unit)
	In branch box/indoor unit section (h1)	$h1 \leq 15$ m
Number of bends	In each indoor unit (h3)	$h3 \leq 12$ m
		$ e1 + d2 + a1 , e1 + d2 + a2 , e1 + d2 + a3 , e1 + d1 + c2 , e1 + d1 + c1 + b2 , e1 + d1 + c1 + b1 + a4 , e1 + d1 + c1 + b1 + a5 , e1 + d1 + c1 + b1 + a6 , e1 + d1 + c1 + b1 + a7 , e1 + d1 + c1 + b1 + a8 \leq 23$

*1: Branch box should be placed within the level between the outdoor unit and indoor units.
2: PKFY-P-VBM, PKFY-P10-32VLM, PFFY-P-VKM, PFFY-P-VCM, and PFFY-P-VL type indoor units cannot be used in a mixed system.

2-Branch boxes

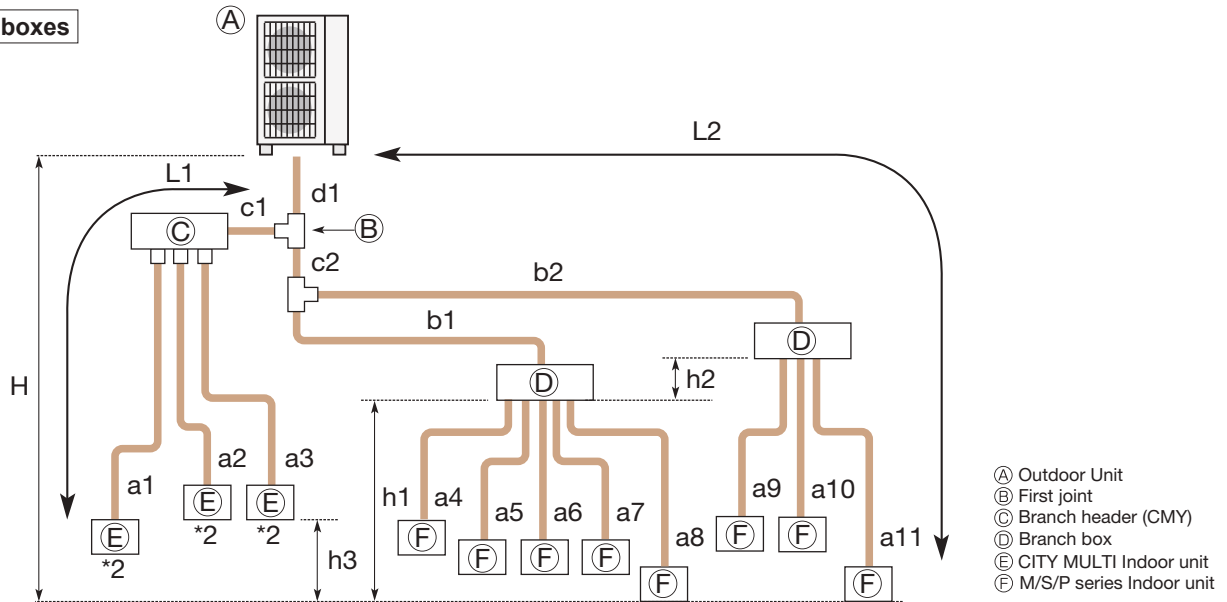

Permissible length (One-way)	Total piping length	$d1 + c1 + c2 + b1 + b2 + a1 + a2 + a3 + a4 + a5 + a6 + a7 + a8 + a9 + a10 + a11 \leq 310$ m
	Farthest piping length (L1)	$d1 + c1 + a1 \leq 85$ m
	Farthest piping length. Via Branch box (L2)	$d1 + c2 + b2 + a11 \leq 80$ m
	Piping length between outdoor unit and branch boxes	$d1 + c2 + b1 + b2 \leq 95$ m
	Farthest piping length from the first joint	$c2 + b2$ or $c1 + a1 \leq 30$ m
	Farthest piping length after branch box	$a11 \leq 25$ m
Permissible height difference (One-way)	Total piping length between branch boxes and indoor units	$a4 + a5 + a6 + a7 + a8 + a9 + a10 + a11 \leq 145$ m
	In indoor/outdoor section (H)*1	$H \leq 50$ m (In case of outdoor unit is set higher than indoor unit) $H \leq 40$ m (In case of outdoor unit is set lower than indoor unit)
	In branch box/indoor unit section	$h1 + h2 \leq 15$ m
	In each branch unit (h2)	$h2 \leq 15$ m
Number of bends	In each indoor unit (h3)	$h3 \leq 12$ m
		$ d1 + c1 + a1 , d1 + c1 + a2 , d1 + c1 + a3 , d1 + c2 + b1 + a4 , d1 + c2 + b1 + a5 , d1 + c2 + b1 + a6 , d1 + c2 + b1 + a7 , d1 + c2 + b1 + a8 , d1 + c2 + b2 + a9 , d1 + c2 + b2 + a10 , d1 + c2 + b2 + a11 \leq 23$

*1: Branch box should be placed within the level between the outdoor unit and indoor units.
2: PKFY-P-VBM, PKFY-P10-32VLM, PFFY-P-VKM, PFFY-P-VCM, and PFFY-P-VL type indoor units cannot be used in a mixed system..

PUMY-P250/300YBM2(-BS)

3-Branch boxes

- Ⓐ Outdoor Unit
- Ⓑ First joint
- Ⓒ Branch header (CMY)
- Ⓓ Branch box
- Ⓔ CITY MULTI Indoor unit
- Ⓕ M/S/P series Indoor unit

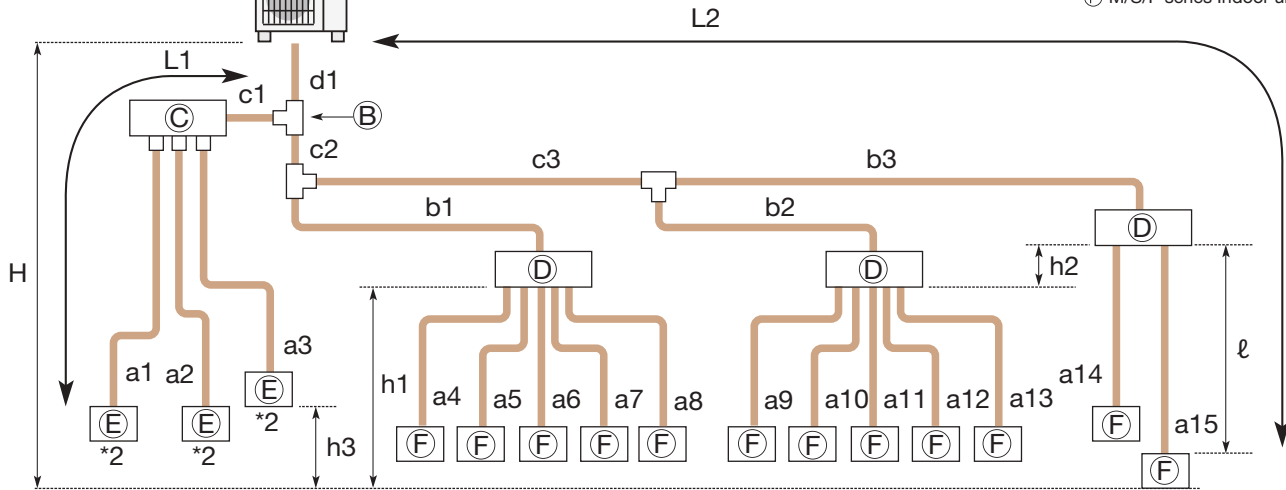

Permissible length (One-way)	Total piping length	$d1 + c1 + c2 + c3 + b1 + b2 + b3 + a1 + a2 + a3 + a4 + a5 + a6 + a7 + a8 + a9 + a10 + a11 + a12 + a13 + a14 + a15 \leq 310$ m
	Farthest piping length (L1)	$d1 + c1 + a1 \leq 85$ m
	Farthest piping length. Via Branch box (L2)	$d1 + c2 + c3 + b3 + a15 \leq 80$ m
	Piping length between outdoor unit and branch boxes	$d1 + c2 + c3 + b1 + b2 + b3 \leq 95$ m
	Farthest piping length from the first joint	$c2 + c3 + b3$ or $c1 + a1 \leq 30$ m
	Farthest piping length after branch box (l)	$a15 \leq 25$ m
	Total piping length between branch boxes and indoor units	$a4 + a5 + a6 + a7 + a8 + a9 + a10 + a11 + a12 + a13 + a14 + a15 \leq 145$ m
Permissible height difference (One-way)	In indoor/outdoor section (H)*1	$H \leq 50$ m (In case of outdoor unit is set higher than indoor unit) $H \leq 40$ m (In case of outdoor unit is set lower than indoor unit)
	In branch box/indoor unit section	$h1 + h2 \leq 15$ m
	In each branch unit (h2)	$h2 \leq 15$ m
	In each indoor unit (h3)	$h3 \leq 12$ m
Number of bends	$ d1 + c1 + a1 , d1 + c1 + a2 , d1 + c1 + a3 ,$ $ d1 + c2 + b1 + a4 , d1 + c2 + b1 + a5 , d1 + c2 + b1 + a6 , d1 + c2 + b1 + a7 ,$ $ d1 + c2 + b1 + a8 , d1 + c2 + c3 + b2 + a9 , d1 + c2 + c3 + b2 + a10 ,$ $ d1 + c2 + c3 + b2 + a11 , d1 + c2 + c3 + b2 + a12 , d1 + c2 + c3 + b2 + a13 ,$ $ d1 + c2 + c3 + b3 + a14 , d1 + c2 + c3 + b3 + a15 \leq 23$	

*1: Branch box should be placed within the level between the outdoor unit and indoor units.

2: PKFY-P-VBM, PKFY-P10-32VLM, PFFY-P-VKM, PFFY-P-VCM, and PFFY-P-VL type indoor units cannot be used in a mixed system.

Explanation of Terminology

Maximum piping length:

This is the [maximum allowable length of the refrigerant piping](#). The amount of refrigerant pipe used cannot be longer than the length specified.

Total length:

The maximum allowable combined length of all the refrigerant piping between the outdoor unit and indoor unit(s).

Outdoor Unit - Indoor Unit:

The maximum allowable length of the refrigerant piping between the outdoor unit and indoor units installed when multiple units are connected to a single outdoor unit. This distance limitation refers to the maximum length between the outdoor unit and the farthest indoor unit.

Pipe length difference from distribution pipe:

The maximum allowable difference in refrigerant piping length from the distribution pipe to the farthest indoor unit and from the distribution pipe to the closest indoor unit when multiple indoor units are connected to a single outdoor unit using a distribution pipe.

Indoor Unit - Distribution Pipe:

The maximum allowable length of the refrigerant piping between indoor units and the distribution pipe when multiple indoor units are connected to a single outdoor unit.

Maximum height difference:

This is the [maximum allowable height difference](#). It is necessary to install the air conditioning system so that the height distance is no more than the difference specified. (Specified differences may vary if the outdoor unit is installed higher or lower than the indoor units).

Outdoor unit - Indoor unit:

The maximum allowable difference in height between the outdoor unit and indoor units when installed (when multiple indoor units are connected to a single outdoor unit, this distance limitation refers to the maximum height difference between the outdoor unit and an indoor unit).

Indoor unit - Indoor unit:

The maximum allowable difference between the heights of indoor units when multiple indoor units are connected to a single outdoor unit.

Maximum number of bends:

This is the [maximum allowable number of bends in the refrigerant piping](#). The total number of bends in the refrigerant piping used cannot exceed the number specified.

Total number:

The maximum allowable number of bends for all refrigerant piping between the outdoor unit and indoor units.

Outdoor unit - Indoor unit:

The maximum allowable number of bends between the outdoor unit and each indoor unit when multiple indoor units are connected to a single outdoor unit.

Conditions for specifications

Temperature conditions are based on JIS B8616.

Cooling	Indoor	27°C DB, 19°C WB
	Outdoor	35°C DB, 24°C WB
Heating	Indoor	20°C DB
	Outdoor	7°C DB, 6°C WB

Refrigerant piping length ; 5m

The figures for total input are based on the following voltages.

Series	Indoor unit	Outdoor unit
M Series S Series P Series (except for PEA) MXZ Series POWERFUL HEATING Series	-	VF, VG, VE, VA, VHA, VKA: 230V/Single phase/50Hz YA, YHA, YKA: 400V/Three phase/50Hz
PEA Series	400V/Three phase/50Hz	400V/Three phase/50Hz

Sound pressure level

- The sound pressure measurement is conducted in an anechoic chamber.
- The actual sound level depends on the distance from the unit and the acoustic environment.

How to read a model name

1) M & S Series

M	M : M Series S : S Series
S	"S"= Wall-mounted , "F"= Compact floor-standing , "E"= Compact ceiling-concealed , "L"= 4- or 1-way cassette , "U"= Outdoor unit
Z	"Z"= Inverter heat pump , "H"= Fixed-speed heat pump , "blank"= Cooling only of Non-inverter , "Y"= Cooling only of inverter
-	
F	Series
H	Generation
25	Rated cooling capacity (kW base)
V	230V / Single phase / 50Hz
E	"A"= R410A with new A control , "B"= R410A with conventional control , "E"= R410A with new A control & ErP correspondance , "G"=R32 with new A control & ErP correspondance , "F"= R32 with new A control
HZ	"HZ"= Hyper Heating model , "H"= Anti-freeze heater equipped model , "S"= Silver indoor unit , "W"= White/Natural White indoor unit , "B"= Black/Onyx Black indoor unit , "V"= Pearl White indoor unit , "R"= Ruby Red indoor unit

2) P Series

P	P Series
U	"K"= Wall-mounted , "S"= Floor-standing , "L"= 4-way cassette , "E"= Ceiling-concealed , "C"= Ceiling-suspended , "U"= Outdoor unit
H	"H"= For heating and cooling
Z	"Z"= Inverter
-	

ZM/M/ZRP/RP/P "ZM"= R32 Eco-conscious Power Inverter , "M"= R32 &R410A

"ZRP"/"RP"= R410A & cleaning-free pipe reuse , "P"=R410A

SHW "SH"= Powerful heating ZUBADAN , "W"= can be used as air to water application

71	Rated cooling capacity (kW base)
V	"V"= 230V / Single phase / 50Hz , "Y"= 400V / Three phase / 50Hz
H	Generation
A	"A"= A control

3) MXZ Series

M	M Series
X	Multi-system outdoor unit (heat pump)
Z	Inverter heat pump
-	
4	Maximum number of connectable indoor units
D/E/F/HJ/DM/HA	Generation / Type
72	Rated cooling capacity (kW base)
V	"V"= 230V / Single phase / 50Hz , "F"= R32 with new A control
A/F	"A"= R410A with new A control
HZ	"HZ"= Hyper Heating model , "H"= Anti-freeze heater equipped model

Refrigerant Amount

M/S/P/Multi/Zubadan/ATW

	Model Name	Refrigerant	Pre-charged quantity			Max. added quantity	
			GWP	Weight [kg]	CO ₂ equivalent [t]	Weight [kg]	CO ₂ equivalent [t]
	MUZ-RW25VG	R32	675	1.20	0.81	1.40	0.95
	MUZ-RW35VG	R32	675	1.10	0.74	1.30	0.88
	MUZ-RW50VG	R32	675	1.21	0.82	1.51	1.02
	MUZ-LN25VG	R32	675	1.00	0.68	0.26	0.18
	MUZ-LN25VG2	R32	675	0.8	0.54	0.20	0.135
	MUZ-LN35VG	R32	675	1.00	0.68	0.26	0.18
	MUZ-LN35VG2	R32	675	0.85	0.57	0.20	0.14
	MUZ-LN50VG	R32	675	1.25	0.85	0.26	0.18
	MUZ-LN50VG2	R32	675	1.25	0.85	0.10	0.07
	MUZ-LN60VG	R32	675	1.45	0.98	0.46	0.32
	MUZ-LN25VGHZ	R32	675	1.00	0.68	0.26	0.18
	MUZ-LN35VGHZ	R32	675	1.00	0.68	0.26	0.18
	MUZ-LN50VGHZ	R32	675	1.45	0.98	0.46	0.32
	MUZ-FT25VGHZ	R32	675	0.85	0.58	0.25	0.17
	MUZ-FT35VGHZ	R32	675	0.95	0.65	0.45	0.31
	MUZ-FT50VGHZ	R32	675	0.95	0.65	0.45	0.31
	MUZ-AP15VG	R32	675	0.49	0.34	0.26	0.18
	MUZ-AP20VG	R32	675	0.55	0.37	0.26	0.18
	MUZ-AY25VG	R32	675	0.55	0.37	0.26	0.18
	MUZ-AY35VG	R32	675	0.55	0.37	0.26	0.18
	MUZ-AY42VG	R32	675	0.70	0.47	0.26	0.18
	MUZ-AY50VG	R32	675	1.00	0.68	0.26	0.18
	MUZ-AP60VG	R32	675	1.05	0.71	0.30	0.20
	MUZ-AP71VG	R32	675	1.50	1.02	0.30	0.20
	MUZ-AY25VGH	R32	675	0.55	0.37	0.26	0.18
	MUZ-AY35VGH	R32	675	0.55	0.37	0.26	0.18
	MUZ-AY42VGH	R32	675	0.70	0.47	0.26	0.18
	MUZ-AY50VGH	R32	675	1.00	0.68	0.26	0.18
	MUZ-EF25VGH(H)	R32	675	0.62	0.42	0.26	0.18
	MUZ-EF35VGH(H)	R32	675	0.74	0.50	0.26	0.18
	MUZ-EF42VG	R32	675	0.74	0.50	0.26	0.18
	MUZ-EF50VG	R32	675	1.05	0.71	0.46	0.32
	MUZ-BT20VG	R32	675	0.45	0.30	0.26	0.18
	MUZ-BT25VG	R32	675	0.50	0.34	0.26	0.18
	MUZ-BT35VG	R32	675	0.50	0.34	0.26	0.18
	MUZ-BT50VG	R32	675	0.70	0.47	0.26	0.18
	MUZ-HR25VF	R32	675	0.40	0.27	0.26	0.18
	MUZ-HR35VF	R32	675	0.45	0.30	0.26	0.18
	MUZ-HR42VF	R32	675	0.70	0.47	0.26	0.18
	MUZ-HR50VF	R32	675	0.80	0.54	0.26	0.18
	MUZ-HR60VF	R32	675	1.05	0.71	0.46	0.32
	MUZ-HR71VF	R32	675	1.05	0.71	0.46	0.32
	MUZ-DW25VF	R32	675	0.50	0.34	0.25	0.17
	MUZ-DW35VF	R32	675	0.55	0.38	0.25	0.17
	MUZ-DW50VF	R32	675	0.97	0.66	0.25	0.17
	MUYTP35VF	R32	675	0.85	0.57	0.13	0.09
	MUYTP50VF	R32	675	0.85	0.57	0.13	0.09
	MUZ-FH25VE	R410A	2088	1.15	2.41	0.39	0.82
	MUZ-FH35VE	R410A	2088	1.15	2.41	0.39	0.82
	MUZ-FH50VE	R410A	2088	1.55	3.24	0.46	0.97
	MUZ-FH25VEHZ	R410A	2088	1.15	2.41	0.39	0.82
	MUZ-FH35VEHZ	R410A	2088	1.15	2.41	0.39	0.82
	MUZ-FH50VEHZ	R410A	2088	1.55	3.24	0.46	0.97
	MUZ-SF25VE(H)	R410A	2088	0.70	1.47	0.39	0.82
	MUZ-SF35VE(H)	R410A	2088	0.80	1.68	0.39	0.82
	MUZ-SF42VE(H)	R410A	2088	1.15	2.41	0.39	0.82
	MUZ-SF50VE(H)	R410A	2088	1.55	3.24	0.46	0.97
	MUZ-GF60VE	R410A	2088	1.55	3.24	0.40	0.84
	MUZ-GF71VE	R410A	2088	1.90	3.97	1.10	2.30
	MUZ-WN25VA	R410A	2088	0.70	1.47	0.26	0.55
	MUZ-WN35VA	R410A	2088	0.70	1.47	0.26	0.55
	MUZ-DM25VA	R410A	2088	0.70	1.47	0.26	0.55
	MUZ-DM35VA	R410A	2088	0.72	1.51	0.26	0.55
	MUZ-HJ25VA	R410A	2088	0.70	1.47	0.26	0.55
	MUZ-HJ35VA	R410A	2088	0.72	1.51	0.26	0.55
	MUZ-HJ50VA	R410A	2088	1.15	2.41	0.26	0.55
	MUZ-HJ60VA	R410A	2088	1.80	3.76	0.46	0.97
	MUZ-HJ71VA	R410A	2088	1.80	3.76	0.46	0.97
	MUFZ-KW25VGHZ	R32	675	1.0	0.68	1.26	0.86
	MUFZ-KW35VGHZ	R32	675	1.0	0.68	1.26	0.86
	MUFZ-KW50VGHZ	R32	675	1.3	0.88	1.76	1.19
	MUFZ-KW60VGHZ	R32	675	1.3	0.88	1.76	1.19
	MXZ-2D33VA	R410A	2088	1.15	2.72	0.0	0.00
	MXZ-2D42VA2	R410A	2088	1.3	2.72	0.2	0.42
	MXZ-2D53VA(H)2	R410A	2088	1.3	2.72	0.2	0.42
	MXZ-3E54VA	R410A	2088	2.7	5.64	0.2	0.42
	MXZ-3E68VA	R410A	2088	2.7	5.64	0.4	0.84
	MXZ-4E72VA	R410A	2088	2.7	5.64	0.4	0.84
	MXZ-4E83VA	R410A	2088	2.99	6.25	0.9	1.88
	MXZ-5E102VA	R410A	2088	2.99	6.25	1.6	3.35
	MXZ-6D122VA	R410A	2088	4.0	8.36	1.0	2.09
	MXZ-2F33VF4	R32	675	0.8	0.54	0.8	0.54
	MXZ-2F42VF4	R32	675	1.0	0.675	1.0	0.675
	MXZ-2F53VF(H)4	R32	675	1.0	0.675	1.0	0.675
	MXZ-3F54VF4	R32	675	2.4	1.62	0	0
	MXZ-3F68VF4	R32	675	2.4	1.62	0	0
	MXZ-4F72VF4	R32	675	2.4	1.62	0	0
	MXZ-4F80VF4	R32	675	2.4	1.62	0	0
	MXZ-4F83VF2	R32	675	2.4	1.62	0	0
	MXZ-5F102VF2	R32	675	2.4	1.62	0	0
	MXZ-6F120VF2	R32	675	2.4	1.62	0	0
	MXZ-2F53VFHZ2	R32	675	2.4	1.62	0	0
	MXZ-4F83VFHZ2	R32	675	2.4	1.62	0	0
	MXZ-2E53VAHZ	R410A	2088	2.0	4.18	0.2	0.42
	MXZ-4E83VAHZ	R410A	2088	3.9	8.15	0.9	1.88
	MXZ-2DM40VA	R410A	2088	0.95	1.99	0.2	0.42
	MXZ-3DM50VA	R410A	2088	2.7	5.64	0.2	0.42
	MXZ-2HA40VF2	R32	675	0.9	0.61	0.9	0.61
	MXZ-2HA50VF2	R32	675	0.9	0.61	0.9	0.61
	MXZ-3HA50VF2	R32	675	1.4	0.95	1.6	1.08

	Model Name	Refrigerant	Pre-charged quantity			Max. added quantity	
			GWP	Weight [kg]	CO ₂ equivalent [t]	Weight [kg]	CO ₂ equivalent [t]
	SUZ-M25VA	R32	675	0.65	0.44	0.26	0.18
	SUZ-M35VA	R32	675	0.90	0.61	0.26	0.18
	SUZ-M50VA	R32	675	1.20	0.81	0.46	0.31
	SUZ-M60VA	R32	675	1.25	0.84	0.46	0.31
	SUZ-M71VA	R32	675	1.45	0.98	0.92	0.62
	SUZ-KA25VA6	R410A	2088	0.80	1.68	0.39	0.82
	SUZ-KA35VA6	R410A	2088	1.15	2.41	0.39	0.82
	SUZ-KA50VA6	R410A	2088	1.60	3.35	0.46	0.97
	SUZ-KA60VA6	R410A	2088	1.60	3.35	0.46	0.97
	SUZ-KA71VA6	R410A	2088	1.80	3.76	1.265	2.65
	PUZ-ZM35VKA2	R32	675	2.0	1.35	0.3	0.20
	PUZ-ZM50VKA2	R32	675	2.0	1.35	0.3	0.20
	PUZ-ZM60VHA2	R32	675	2.8	1.89	0.8	0.54
	PUZ-ZM71VHA2	R32	675	2.8	1.89	0.8	0.54
	PUZ-ZM100VKA2	R32	675	3.6	2.43	2.4	1.62
	PUZ-ZM100YKA2	R32	675	3.6	2.43	2.4	1.62
	PUZ-ZM125VKA2	R32	675	3.6	2.43	2.4	1.62
	PUZ-ZM140VKA2	R32	675	3.6	2.43	2.4	1.62
	PUZ-ZM140YKA2	R32	675	3.6	2.43	2.4	1.62
	PUZ-ZM200YKA2	R32	675	6.3	4.25	9.2	6.21
	PUZ-ZM250YKA2	R32	675	6.8	4.59	9.2	6.21
	PUHZ-ZRP35VKA2	R410A	2088	2.2	4.60	0.4	0.84
	PUHZ-ZRP50VKA2	R410A	2088	2.4	5.02	0.4	0.84
	PUHZ-ZRP60VHA2	R410A	2088	3.5	7.31	1.2	2.51
	PUHZ-ZRP71VHA2	R410A	2088	3.5	7.31	1.2	2.51
	PUHZ-ZRP100VKA3	R410A	2088	5.0	10.44	2.4	5.02
	PUHZ-ZRP100YKA3	R410A	2088	5.0	10.44	2.4	5.02
	PUHZ-ZRP125VKA3	R410A	2088	5.0	10.44	2.4	5.02
	PUHZ-ZRP125YKA3	R410A	2088	5.0	10.44	2.4	5.02
	PUHZ-ZRP140VKA3	R410A	2088	5.0	10.44	2.4	5.02
	PUHZ-ZRP140YKA3	R410A	2088	5.0	10.44	2.4	5.02
	PUHZ-ZRP200YKA3	R410A	2088	7.1	14.83	3.6	7.52
	PUHZ-ZRP250YKA3	R410A	2088	7.7	16.08	4.8	10.03
	PUZ-M100VKA2	R32	675	3.1	2.1	1.0	0.7
	PUZ-M100YKA2	R32	675	3.1	2.1	1.0	0.7
	PUZ-M125VKA2	R32	675	3.6	2.4	1.4	0.95
	PUZ-M125YKA2	R32	675	3.6	2.4	1.4	0.95
	PUZ-M140VKA2	R32	675	3.6	2.4	1.4	0.95
	PUZ-M140YKA2	R32	675	3.6	2.4	1.4	0.95
	PUZ-M200YKA2	R32	675	5.6	3.78	1.6	1.08
	PUZ-M250YKA2	R32	675	6.8	4.59	2.4	1.62
	PUHZ-P100VKA	R410A	2088	3.3	6.89	1.2	2.51
	PUHZ-P100YKA	R410A	2088	3.3	6.89	1.2	2.51
	PUHZ-P125VKA	R410A	2088	3.8	7.93	1.2	2.51
	PUHZ-P125YKA	R410A	2088	3.8	7.93	1.2	2.51
	PUHZ-P140VKA	R410A	2088	3.8	7.93	1.2	2.51
	PUHZ-P140YKA	R410A	2088	3.8	7.93	1.2	2.51
	PUHZ-P200YKA3	R410A	2088	6.5	13.58	3.6	7.52
	PUHZ-P250YKA3	R410A	2088	7.7	16.08	4.8	10.03
	PUHZ-SHW112VHA	R410A	2088	5.5	11.49	2.4	5.02
	PUHZ-SHW112YHA	R410A	2088	5.5	11.49	2.4	5.02
	PUHZ-SHW140VHA	R410A	2088	5.5	11.49	2.4	5.02
	PUHZ-SHW140YHA	R410A	2088	5.5	11.49	2.4	5.02
	PUHZ-FRP71VHA	R410A	2088	3.8	7.94	1.8	3.76
	PUMY-SP112VKM2(-BS)	R410A	2088	3.5	7.31	9.0	18.79
	PUMY-SP112YKM2(-BS)	R410A	2088	3.5	7.31	9.0	18.79
	PUMY-SP125VKM2(-BS)	R410A	2088	3.5	7.31	9.0	18.79
	PUMY-SP125YKM2(-BS)	R410A	2088	3.5	7.31	9.0	18.79
	PUMY-SP140VKM2(-BS)	R410A	2088	3.5	7.31	9.0	18.79
	PUMY-SP140YKM2(-BS)	R410A	2088	3.5	7.31	9.0	18.79
	PUMY-P112VKM6(-BS)	R410A	2088	4.8	10.02	13.8	28.81
	PUMY-P125VKM5(-BS)	R410A	2088	4.8	10.02	13.8	28.81
	PUMY-P140VKM5(-BS)	R410A	2088	4.8	10.02	13.8	28.81

R32 REFRIGERANT

R32 REFRIGERANT PROPERTIES

Under the conditions shown below, there is a possibility that R32 could ignite.

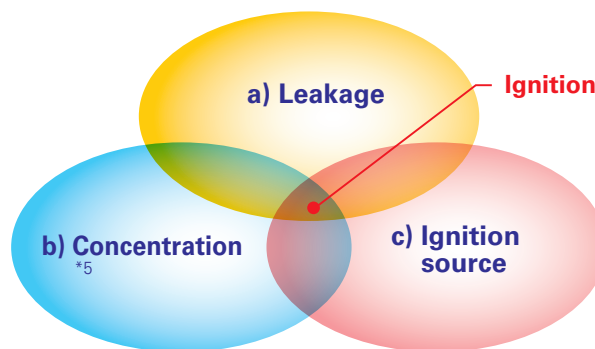

	R32	R410A	R22
Chemical formula	CH ₂ F ₂	CH ₂ F ₂ /CHF ₂ CF ₃	CHClF ₂
Composition (blend ratio wt. %)	Single composition	R32/R125 (50/50 wt %)	Single composition
Ozone depletion potential (ODP)	0	0	0.055
Global warming potential (GWP) *1	675	2088	1810
LFL(vol.%) *2	13.3	–	–
UFL(vol.%) *3	29.3	–	–
Flammability *4	Lower flammability (2L)	No flame propagation (1)	No flame propagation (1)

*1 IPCC 4th assessment report.

*2 LFL : Lower flammable limit

*3 UFL : Upper flammable limit

*4 ISO 817:2014

*5 R32 consistency is higher than LFL*¹ and lower than UFL*².

Although R32 is classified as low flammability, the possibility of igniting can be eliminated by ensuring the following three points.



WARNING

a) Do not leak refrigerant.

- <Installation> ·Vacuum drying should be done. Air purging is prohibited.
- Follow "4. Installation Points of Refrigerant Piping Work"
- <Repair/Relocation/Removal> ·Pump down or recovering refrigerant should be done.

b) Prevent concentration.

- Ventilate during installation and servicing, such as open the door or window and use a fan.
- Follow "2. Installation Restrictions"

c) Keep ignition source away from the unit.

- Do not braze pipe and unit which contain refrigerant. Before brazing, refrigerant should be recovered.
- Do not install unit while the electricity is turned on. Turn off electricity at the fuse box and check the wiring using a tester.
- Do not smoke when working or during transportation of the product.



CAUTION

Both R32 / R410A emit a toxic gas when coming into contact with an open flame.

INSTALLATION RESTRICTIONS

In order to prevent the refrigerant from igniting, use the following instructions during installation.

1) Indoor Units

Install in a room with a floor area of A_{min}^* or more, corresponding to refrigerant quantity M.

(M = factory-charged refrigerant + locally added refrigerant)

Install the indoor unit so that the height from the floor to the bottom of the indoor unit is h_0^* .

* Refer to table and drawings below.

<M Series>		<P Series> ①		<MXZ Series> ②		<Only for MFZ-KT/KW>	
M[kg]	A_{min} [m ²]	M[kg]	A_{min} [m ²]	M[kg]	A_{min} [m ²]	M[kg]	A_{min} [m ²]
0.7	1.7	1.0	4	<1.84	No requirements	1.0	3
0.8	2.0	1.5	6	1.84	6	1.5	4.5
0.9	2.2	2.0	8	2.0	6	2.0	6
1.0	2.5	2.5	10	2.5	7	2.5	7.5
1.1	2.7	3.0	12	3.0	9	3.0	9
1.2	3.0	3.5	14	3.5	10	3.5	12
1.3	3.2	4.0	16	4.0	11	4.0	15.5
1.4	3.4	4.5	20	4.5	13	4.5	20
1.5	3.7	5.0	24	5.0	14	5.0	24
1.6	3.9	5.5	29	5.5	15	5.5	29
1.7	4.2	6.0	35	6.0	17	6.0	35
1.8	4.4	6.5	41	6.5	18	6.5	41
1.9	4.6	7.0	47	7.0	20	7.0	47
2.0	4.9	7.5	54	7.5	21	7.5	54
		8.0	62	8.0	22	8.0	54
		8.5	69	8.5	24	8.5	41
		9.0	78	9.0	25	9.0	47
		9.5	87	9.5	26	9.5	54

① For wall-mounted, ceiling suspended, cassette and concealed
 ② For floor-standing (PSA-M)

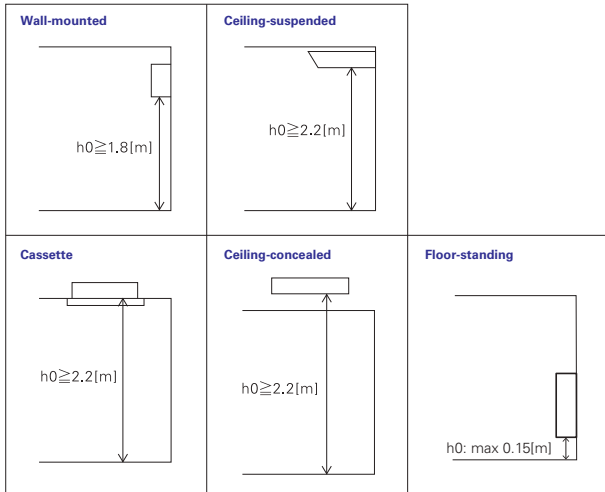

2) Outdoor Units

Install outdoor units in a place where at least one of the four sides is open or in a sufficiently large space without depressions.

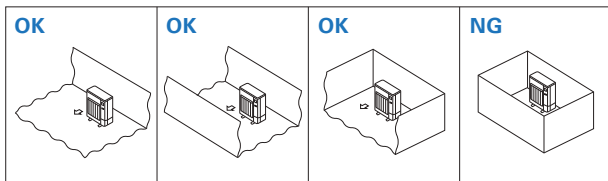

If you unavoidably install a unit in a space where all four sides are blocked or there are depressions, confirm that one of these situations (A, B or C) is satisfied.

A Secure sufficient installation space (minimum installation area A_{min}).

Install in a space with an installation area of A_{min}^* or more, corresponding to refrigerant quantity M. (M = factory-charged refrigerant + locally added refrigerant)

* Refer to table and drawings below.

M[kg]	A_{min} [m ²]
1.0	12
1.5	17
2.0	23
2.5	28
3.0	34
3.5	39
4.0	45
4.5	50
5.0	56
5.5	62
6.0	67
6.5	73
7.0	78
7.5	84
8.0	89
8.5	95
9.0	100
9.5	106

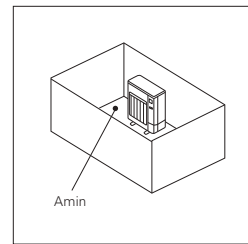

B Install in a space with a depression height of ≤ 0.125 [m].

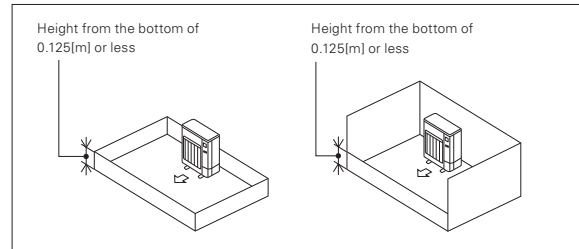

C Create an appropriate open ventilation area.

Make sure that the width of the open area is 0.9[m] or more and the height of the open area is 0.15[m] or more.

However, the height from the bottom of the installation space to the bottom edge of the open area should be 0.125[m] or less.

More than 75% of the ventilation area should be open to allow air circulation.

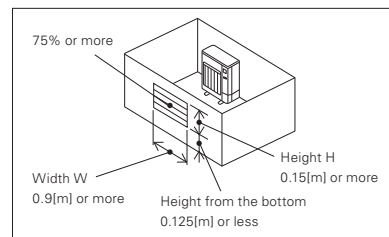

Note These countermeasures (A, B or C) are for keeping safety not for specification guarantee.

● Models with R32 Refrigerant: MSZ-L Series (single connection)









LROSSNAY SYSTEM



SELECTION

LOSSNAY lineup consists of two types of ventilation: Energy Recovery Ventilation (ERV) and Heat Recovery Ventilation (HRV). Choose the model that best matches your building layout and indoor environment.

PRODUCT LINEUP

LOSSNAY			
Energy Recovery Ventilation	Heat Recovery Ventilation		Energy Recovery Ventilation
Centralized Ventilation			Decentralized Ventilation
Ceiling Concealed		Vertical Type	Wall mounted Type
LGH-RVX3 Series A commercially oriented system that can be used to deliver high performance and functions virtually anywhere. 	LGH-RVS Series Sensible heat models of the LGH series that can also be installed in sanitary areas. 	VL-CZPVU Series Vertical type for residential use. Centralized ventilation with sensible heat exchange. 	VL-100(E)U5-E Wall mounted models. Particularly suitable for houses and small offices. 
LGH-RVXT Series Thin, large airflow models of the LGH series that deliver high performance and functions. 			VL-50(E)S2-E VL-50SR2-E 
GUF Series (LOSSNAY with Dx-Coil Unit) Heat recovery units with a heating and cooling system that uses the CITY MULTI outdoor units as a heat source. 	Plasma Quad Protect Air purifier		
	JC-23KR-EU 	JC-4K-EU 	

LOSSNAY LINEUP

Application	Model Model	Airflow	50	100	150	250	350	500	650	800	1000	1500	1600	2000	2500	
			CMH	CMH	CMH	CMH	CMH	CMH	CMH	CMH	CMH	CMH	CMH	CMH	CMH	CMH
Centralized Ventilation	Ceiling Concealed	LGH-RVX3 Series			●	●	●	●	●	●	●		●	●		
		LGH-RVXT Series										●		●	●	
		LGH-RVS Series						●		●	●					
		GUF Series						●		●						
	Vertical Type	VL-CZPVU Series				●	●	●								
Decentralized Ventilation	Wall mounted Type	VL-100(E)U5-E		●												
		VL-50(E)S2-E VL-50SR2-E	●													

Commercial Use LOSSNAY

Mitsubishi Electric offers Energy Recovery Ventilation and Heat Recovery Ventilation solutions for optimizing building air quality by LOSSNAY

Energy Recovery Ventilation

A total heat exchange ventilation system that uses paper characteristics (LOSSNAY core) to perform temperature (sensible heat) and humidity (latent heat) exchange.

ERV Solution

Environment friendly energy recovery and humidity control enables air conditioning systems to simultaneously provide optimum room comfort and energy savings.

- ✓ Total Heat Exchanger
- ✓ Eliminates excess humidity in the air
- ✓ Wide range of airflow lineup

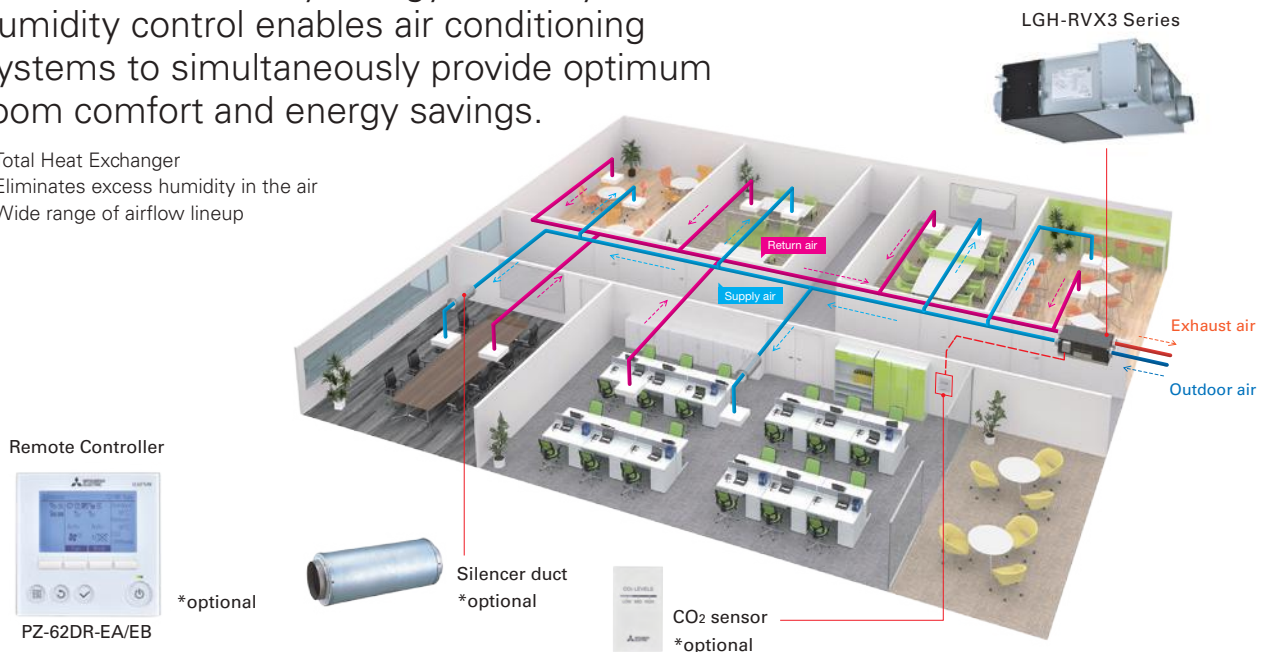

Heat Recovery Ventilation

A heat exchange ventilation system that uses a heat exchanger (LOSSNAY core) to perform temperature (sensible heat) exchange.

HRV Solution

Offering the best system solution for ventilation of all areas including the shower room and bathroom.

- ✓ Heat Exchanger
- ✓ Installation in sanitary areas
- ✓ Control with CO₂ sensor

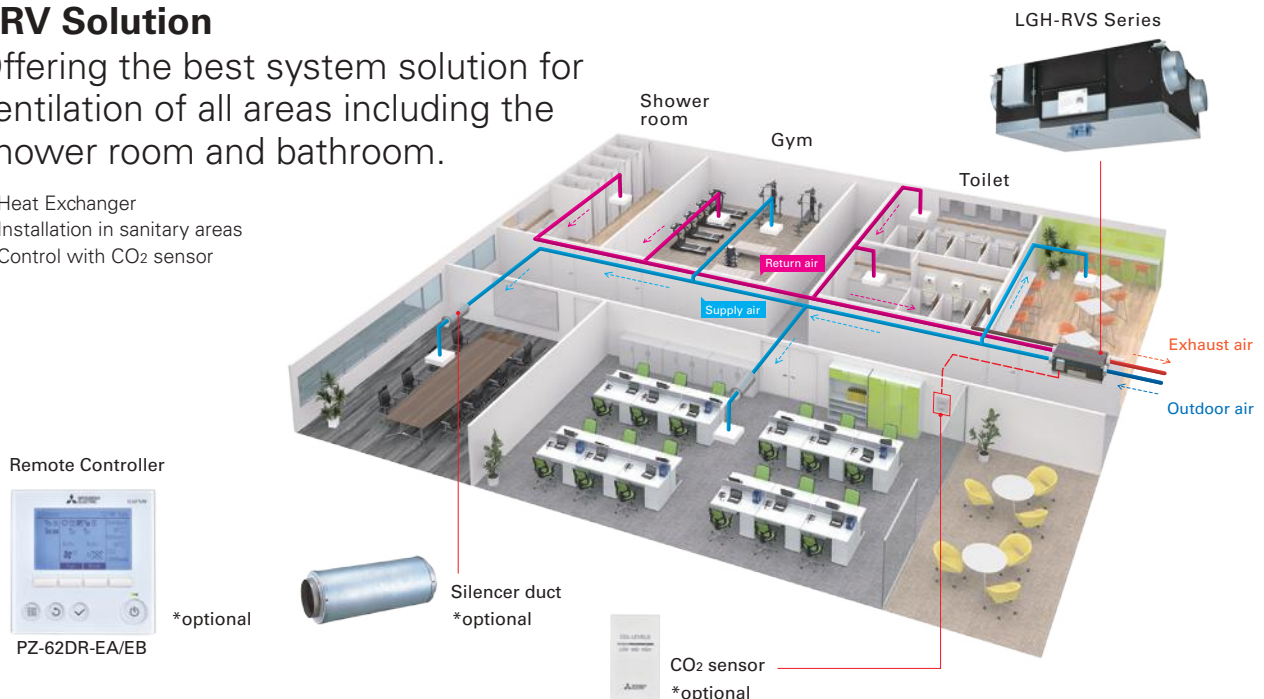

Residential Use LOSSNAY

Mitsubishi Electric offers you decentralized ventilation and centralized ventilation solutions for optimizing your indoor air quality by LOSSNAY.

Heat Recovery Ventilation

A heat exchange ventilation system that uses a heat exchanger (LOSSNAY core) to perform temperature (sensible heat) exchange.

Centralized Ventilation Solution

One LOSSNAY unit provides 24-hour ventilation for the entire house, from living room and bedrooms to the bathroom. The heat recovery system provides fresh air at a comfortable air temperature. A sensible heat exchanger effectively reduces excess humidity in the winter.

- ✓ Heat Exchanger
- ✓ Whole-house Solution
- ✓ Air Purification
- ✓ Quiet Operation
- ✓ MELCloud Control

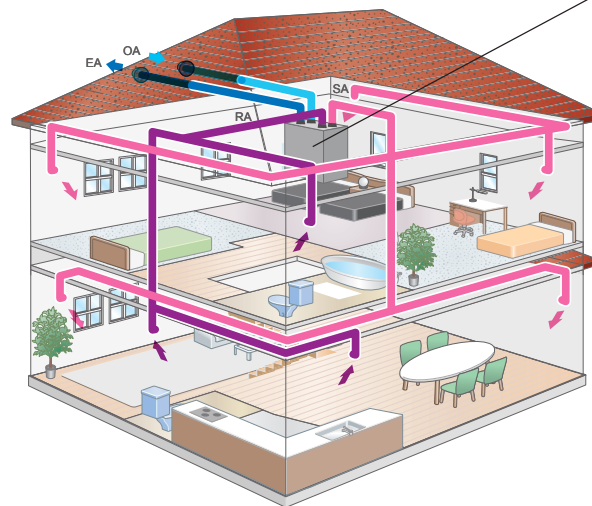

VL250/350/500CZPVU-R-E
VL250/350/500CZPVU-L-E

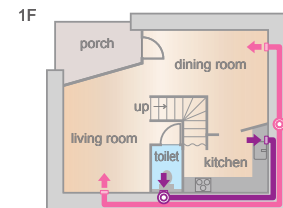
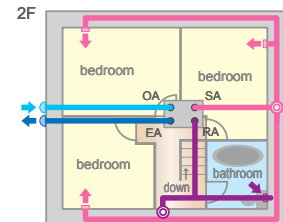

Energy Recovery Ventilation

A total heat exchange ventilation system that uses paper characteristics (LOSSNAY Core) to perform temperature (Sensible heat) and humidity (latent heat) exchange.

Decentralized Ventilation Solution

Install the wall-mounted LOSSNAY in each room. The heat recovery system provides fresh air at a comfortable air temperature. Total heat exchangers effectively reduce heat loss.

- ✓ Total Heat Exchanger
- ✓ Individual Ventilation
- ✓ Flexible Installation
- ✓ Easy Maintenance
- ✓ Stylish Design

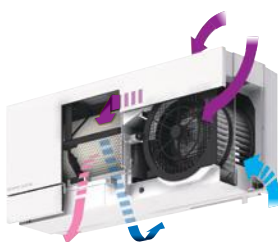

VL-100U₅-E (Pull-Switch Model)
VL-100EU₅-E (Wall-Switch Model)

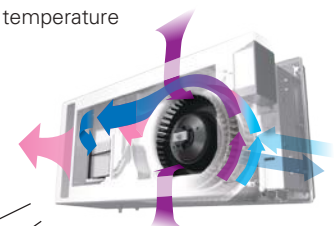
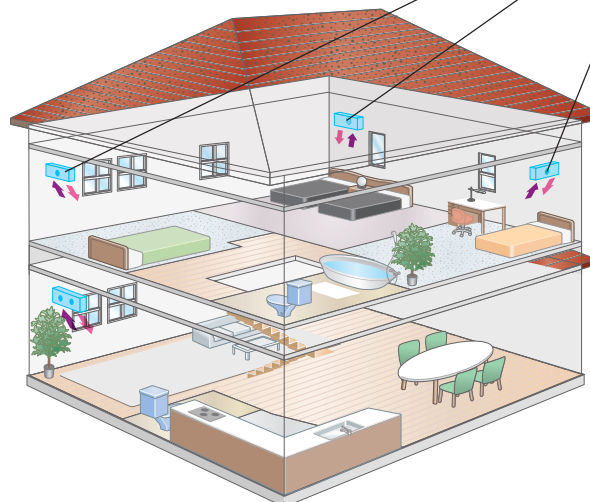

VL50S₂-E (Pull-Switch Model)
VL50ES₂-E (Wall-Switch Model)
VL50SR₂-E (Remote Controller Model)

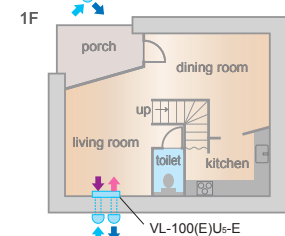
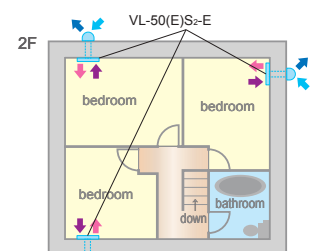

LOSSNAY

LOSSNAY ventilation systems are renowned industry-wide for their efficiency. They offer environment-friendly energy recovery and humidity control, and enable air conditioning systems to simultaneously provide optimum room comfort and energy savings.



Indoor air quality inside a building is optimized through temperature and humidity exchange by LOSSNAY

LOSSNAY is a total heat exchange ventilation system that uses paper characteristics to perform temperature (sensible heat) and humidity (latent heat) exchange.

● The concept of sensible heat and latent heat exchange using LOSSNAY core

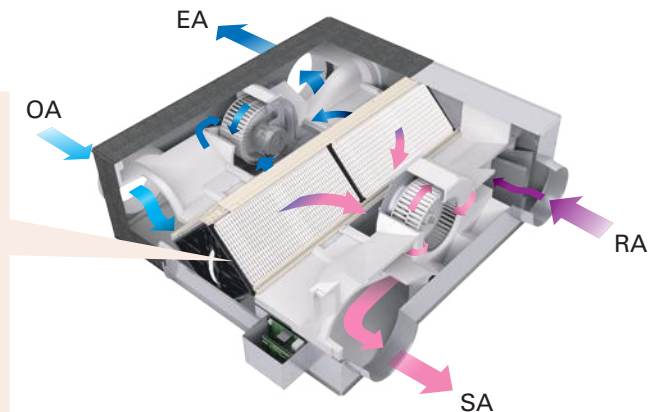
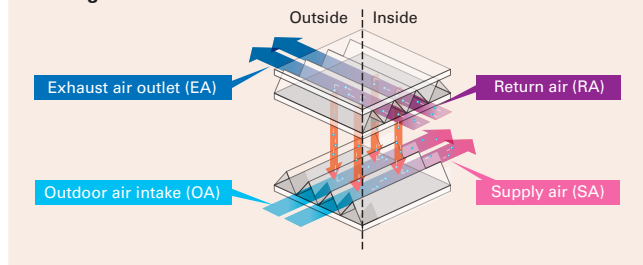

What can be improved by introducing LOSSNAY?

● Ventilation with maximized comfort

In summer

Air similar to the conditions of the cooled (dehumidified) indoor air is supplied.

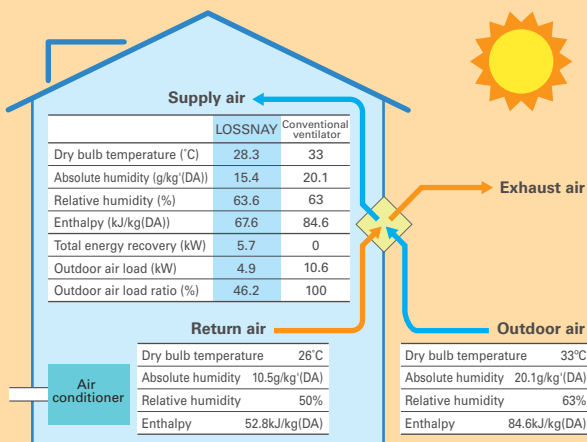

Heat recovery calculation

$$\text{Indoor supply air temperature (°C)} = \frac{\text{Outdoor temperature (°C)}}{\text{temperature (°C)}} \left\{ \frac{\text{Outdoor temperature (°C)} - \text{Indoor temperature (°C)}}{\text{temperature (°C)}} \right\} \times \text{Temp. recovery efficiency (\%)} + \text{Outdoor temperature (°C)}$$

Calculation example: $28.3^\circ\text{C} = 33^\circ\text{C} - (33^\circ\text{C} - 26^\circ\text{C}) \times 67.5\%$

*The above applies to the case of LGH-100RVX3-E. (1000m³/h)

In winter

Air similar to the conditions of the heated (humidified) indoor air is supplied.

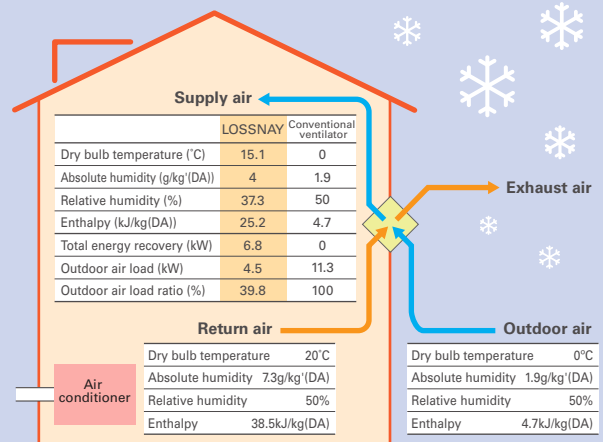

Heat recovery calculation

$$\text{Indoor supply air temperature (°C)} = \left\{ \frac{\text{Indoor temperature (°C)} - \text{Outdoor temperature (°C)}}{\text{temperature (°C)}} \right\} \times \text{Temp. recovery efficiency (\%)} + \text{Outdoor temperature (°C)}$$

Calculation example: $15^\circ\text{C} = (20^\circ\text{C} - 0^\circ\text{C}) \times 75.5\% + 0^\circ\text{C}$

*The above applies to the case of LGH-100RVX3-E. (1000m³/h)

LGH-RVX3 SERIES



A commercially oriented system that can be used to deliver high performance and functions virtually anywhere.

LGH-15/25/35/50/65/80/100/160/200RVX3-E

Four Key Features

High static pressure

External static pressure has been improved compared to previous models. Accompanying this increase in external static pressure, the selection range of models and filters has also expanded. Furthermore, flexible duct work becomes possible.

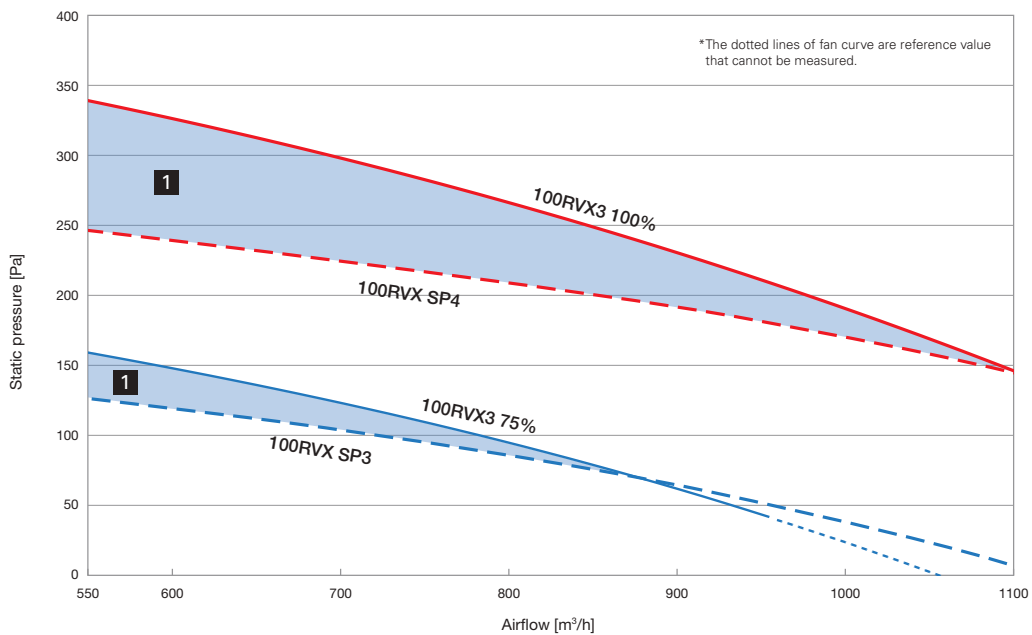

1 Increased static pressure.

Smaller models can be chosen compared to previous models.

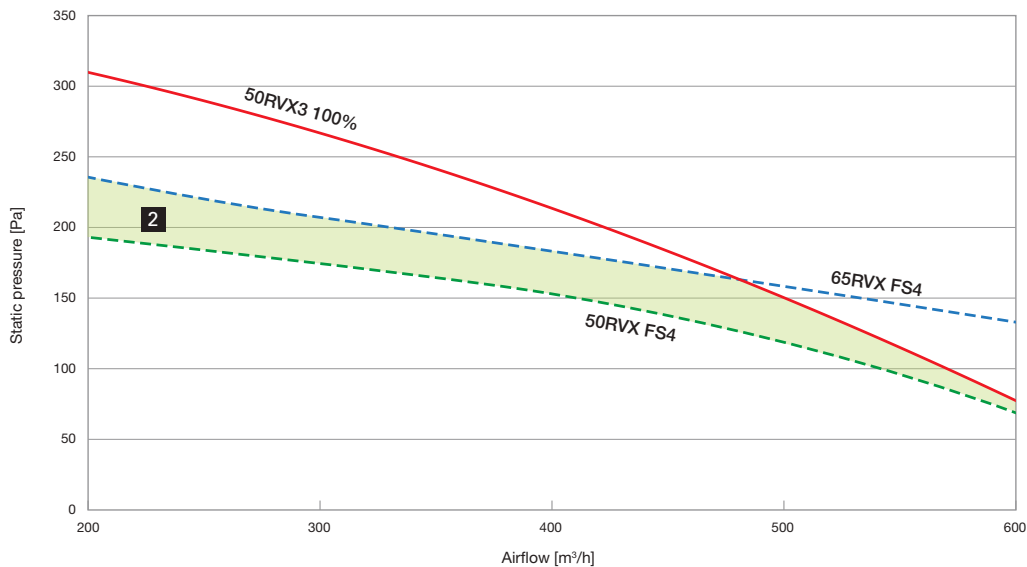

2 Where 65RVX had to be chosen previously, 50RVX3 (one size down) may now be chosen, owing to its increased external static pressure.

Controllability

1. Improved airflow range

Variable air control

The default fan speed value (Fan speed 1: 25%, Fan speed 2: 50%, Fan speed 3: 75%, and Fan speed 4: 100%) of both supply air and exhaust air can be adjusted flexibly. Within the range between 25% and 100%, airflow can be adjusted by 5% increments to satisfactorily meet the designed airflow rate.

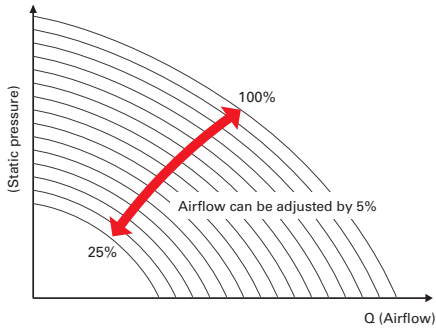

Airflow		
Add. 1	Supply / Exhaust	
	30 %	30 %
	35 %	50 %
	75 %	50 %
	100 %	90 %

Speed select:

▼ Cursor ▲



PZ-62DR-EA/EB

2. New CO₂ sensor

A CO₂ sensor connected directly to a LOSSNAY RVX3 unit optimizes the fan speed according to the levels of CO₂ detected. It improves total heat exchange efficiency and contributes to energy savings.

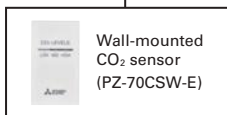

Wall-mounted CO₂ sensor (PZ-70CSW-E)

OR



Duct-mounted CO₂ sensor (PZ-70CSD-E)

Two types of CO₂ sensors are available: wall-mounted and duct-mounted types. Power is supplied to the CO₂ sensor from the Lossnay board.

Fan speed automatically changes from 25% to 100% (16 steps) depending on the level of CO₂ concentration.

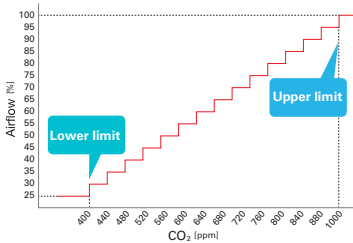

Both upper and lower limits can be adjusted.
 Upper limit: from 600 to 2000 ppm.
 Lower limit: from 300 to (upper limit - 300) ppm.
 50 ppm increments.

CO ₂ control		
▶CO ₂ control	No	Yes
CO ₂ upper limit	1600	ppm
CO ₂ lower limit	450	ppm

Select:

▼ Cursor ▲



PZ-62DR-EA/EB

Automatic operation with CO₂ sensor

Fan speed automatically changes depending on CO₂ concentration.

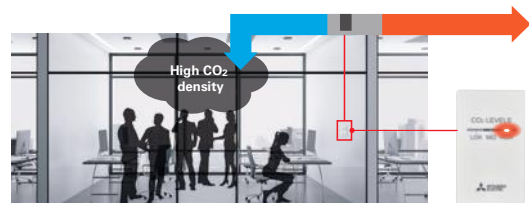
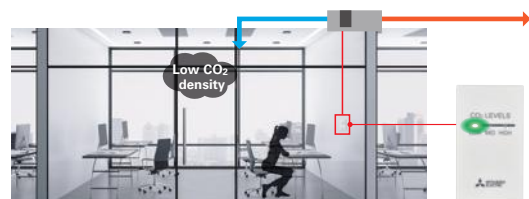



Dual Barrier Coating

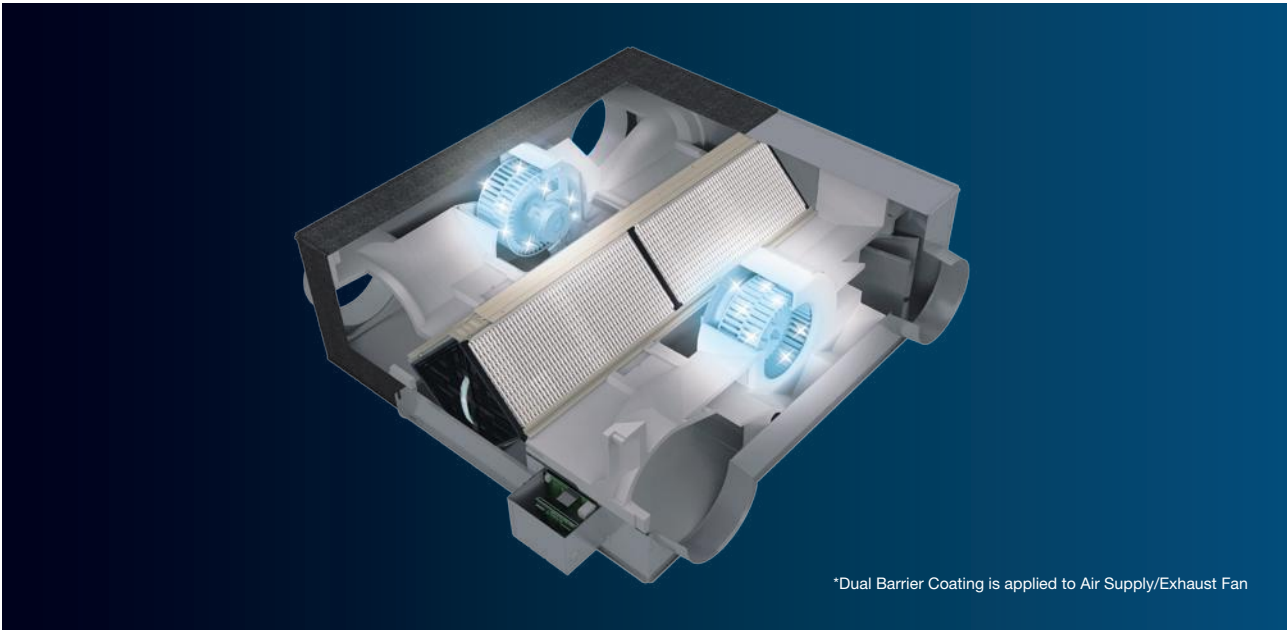

Dual barrier coating

A water-repellent effect is achieved by creating a coating film that has nano-sized concave-convex structures formed by silica nanoparticles made of water-repellent fluororesin and micron-sized concave-convex structures formed by combining micron-sized special-shaped particles (silicate) with the silica nanoparticles. At the same time, the uneven structure forms an air layer that suppresses the adhesion of dust and sand that contain a lot of humidity, reducing the amount of dirt that adheres to the substrate.

■ Conceptual image of dual barrier coating

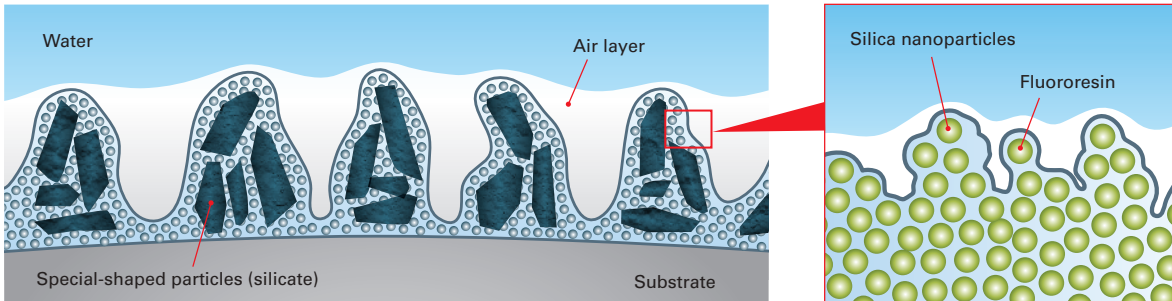

Upgraded filters

The standard filter has been improved from Coarse 35% to Coarse 60% (measured by ISO16890:2016).

PZ-**RF3-E
Standard filter



For Installer

Improved workability

Commissioning time

Using a designed motor and new remote controller, a genius algorithm is introduced to reduce the time of airflow adjustment.

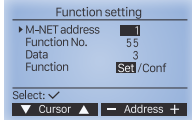
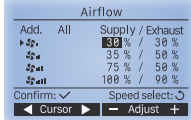
	RVX series (PZ-61DR-E)	RVX3 series (PZ-62DR-EA/EB)
Motor	Fan speed was not adjusted quickly.	Fan speed is adjusted quickly by using a designed motor.
Screen setting	 <p>Fan speed can be set by Function setting which needs the settig table. (Not intuitive)</p>	 <p>Fan speed can be set by new display "Airflow setting" where user can set intuitively.</p>

For example, when checking airflow volume twice in SA side → Commissioning time is reduced by 75%*1

*1 The average reduction rate when our workers actually install LGH-100RVX-E and LGH-100RVX3-E. Setting work involves changing the air volume of supply/exhaust air, and the amount of the time that can be reduced varies depending on the operator and work conditions.

		RVX series (PZ-61DR-E)		RVX3 series (PZ-62DR-EA/EB)		
SA	FS4	Adjust to original speed	173s	100%	Adjust to original speed	20s
		Check airflow volume → too much	-		Check airflow volume → too much	-
	OFF	Fan speed setting FS4 → FS3+3	61s	OFF	Airflow setting 100% → 90%	40s
	FS3+3	Adjust to set speed	94s	90%	Adjust to set speed	20s
		Check airflow volume → too much	-		Check airflow volume → too much	-
	OFF	Fan speed setting FS3+3 → FS3+1	61s	OFF	Airflow setting 90% → 80%	40s
	FS3+1	Adjust to set speed	162s	80%	Adjust to set speed	20s
		Check airflow volume → OK	-		Check airflow volume → OK	-
		Total 551s			Total 140s	

Vertical Installation

By enabling vertical installation, the choices of installation location have expanded.



RVX3 can be installed vertically using optional parts. It can be installed practically anywhere, such as in the machine room, the edges of a room, and so on. Please follow the installation manual when you install RVX3 series vertically.

Model name	LOSSNAY
PZ-1VS-E	LGH-15RVX3-E
	LGH-25RVX3-E
	LGH-35RVX3-E
	LGH-50RVX3-E
PZ-2VS-E	LGH-65RVX3-E
	LGH-80RVX3-E
	LGH-100RVX3-E

Mitsubishi Electric Ventilator Selection Tool

Appropriate information can be obtained from the required air volume and required static pressure.

The screenshot displays the Mitsubishi Electric Ventilator Selection Tool interface. The top navigation bar includes 'Home', 'Climate', 'SA Comparison', 'Lossnay Benefit', 'Heater', and 'Print Header'. The 'Required Duty' section shows input values: Airflow (300 m³/h), Static Pressure (20 Pa), Airflow Tolerance (Max 120%, Min 35%), and Power Source (230V/50Hz/Single-phase). The 'Selected Model' section is set to 'LGH-80RVS-E'. Below this, there are tabs for 'Spec Sheet', 'Photo', 'IB/IM', 'YouTube', '2D CAD', and '3D CAD'. The main content area is divided into 'FAN DATA SHEET' and 'Technical Data'. The 'FAN DATA SHEET' includes a 3D model of the fan and a 'GRAPH' showing 'Actual Duty' and 'Static Pressure (Pa)' versus 'Airflow (m³/h)'. The 'Technical Data' section provides 'Product Basic Information' and 'Actual Duty Specification'. The 'Accessories' table lists various filter and silencer options.

Model	Range, Mounting	Power Source	Tolerance, Actual Duty	STP	Noise dB(A)	Description
LGH-80RVS-E	Heat Recovery, Ceiling mounted	230-240V 50Hz, Single-ph size	102% 300m ³ /h 22Pa	0.54	48B	DC Motor
LGH-80RVS-E	Heat Recovery, Ceiling mounted	240-240V 50Hz, Single-ph size	102% 306m ³ /h 22Pa	0.5	48B	DC Motor
LGH-100RVS-E	Heat Recovery, Ceiling mounted	230-240V 50Hz, Single-ph size	102% 302m ³ /h 20Pa	0.49	48B	DC Motor
LGH-15RVS-E	Energy Recovery, Ceiling mounted	230-240V 50Hz, Single-ph size	116% 347m ³ /h 25Pa	0.64	27dB	DC Motor

Model	Description	Spec	Manual	Select
FZ-580RF-E	Filter G3	PDF	PDF	<input type="checkbox"/>
FZ-580RFM-E	Filter M8	PDF	PDF	<input type="checkbox"/>
FZ-580RFH-E	Filter H8	PDF	PDF	<input type="checkbox"/>
FZ-250SS-E	Straight Silencer	PDF	PDF	<input type="checkbox"/>

Technical Data

Product Basic Information

- Product Range: Heat Recovery
- Case Type: Centrifugal
- Casing Material: Galvanized steel sheet
- Speed Control: 100%/75%/50%/25%
- Weight: 63kg
- Electrical Supply: 230-240V / 50Hz / Single-phase
- Operating Conditions: Hours an unit can run are indicated by high humidity room use shown later in the manual for details.

Actual Duty Specification

- Required Duty: 300m³/h @ 20Pa
- Actual Duty: 306m³/h @ 20.5Pa
- Tolerance: 102.0%
- Fan Speed Setting: 25%
- Power Input: 43W
- Specific Fan Power: 0.50W/(l/s)
- Sound Level: 48B @ 3m

ACOUSTIC INFORMATION

	60	110	200	300	40	50	Total Loss	dB
Inlet	42	49	44	36	27	18	11	20
Outlet	45	48	45	44	40	35	15	15
Breakout	33	49	41	33	23	14	13	18

This picture is an example of LGH-80RVS-E, which is a different model from RVX3 series.

LGH-RVXT SERIES



The LGH-RVXT Series has a large airflow of 1500-2500 CMH but a thin body of approximately 500mm. Therefore, the unit can be easily installed in the ceiling.

LGH-150/200/250RVXT-E

Thin body type

■ LGH-200RVX3-E



Height: 808mm

■ LGH-150/200/250RVXT-E



Height: 500mm

38%
Thinner
body

■ LGH-RVXT installation image

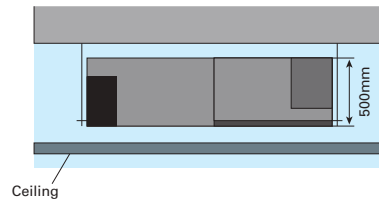

LGH-RVS SERIES

The LGH-RVS Series of sensible heat LOSSNAY models allows diverse solutions and options in response to customer needs.

LGH-50/80/100RVS-E



Easy installation

Light Chassis

Being light in weight is one of the most important factors for installation. The light chassis of the LGH-RVS series can provide a huge advantage in terms of installation cost and safety.

Easy Drain Piping

- Only one drain piping for both SA and EA.
- 360-degree drain pipe connection.
- Trap piping work is NOT required owing to an internal backflow stopper.

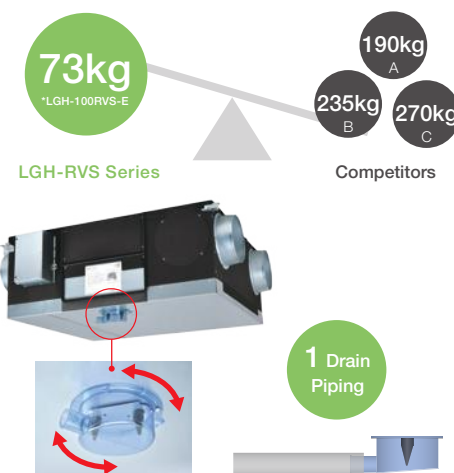

Various optional parts

The LGH-RVS series can connect with various optional parts. A CO₂ sensor is one of the best solutions for optimized airflow control. The unit operates while optimizing airflow in accordance with the level of CO₂ condensation in the room. Optimized ventilation can reduce the energy consumption of the air conditioner. A high-efficiency filter can be optionally installed in the unit as an easy solution for even better indoor air quality.

■ CO₂ sensor



■ Filter



■ Silencer duct



GUF SERIES



Along with LOSSNAY ventilation, the OA processing unit is really two units in one, functioning as the main air conditioner when the load is light and adding supplemental air conditioning when the load is heavy.

GUF-50/100RD4, GUF-50/100RDH4

These units can be used with R410A. Outdoor units available in the GUF-RD/RDH series (For details see Mitsubishi Electric's CITY MULTI catalog).

R410A refrigerant units

Model Size	P112	P125	P140	P200	P250	P300	P350	P400	P450	P500	P550	P600	P650	P700	P750	P800
Y Series	PUHY-YGM-A			●	●	●	●	●	●	●	●	●	●	●	●	●
R2 Series	PURY-YGM-A			●	●	●	●	●	●	●	●	●	●			
PUMY Series	PUMY-SP	●	●	●												
	PUMY-P	●	●	●	●											

LOSSNAY ventilation and Air conditioning

The OA (outdoor-air) Processing Unit creates an optimum environment while providing substantial energy savings. The OA Processing Unit comprises forced air ventilation, heat recovery, heating and cooling, and air purification. This total air conditioning system keeps indoor air fresh and comfortable all year round, and keeps it free of contaminants preventing ailments such as sick building syndrome. Inside the OA Processing Unit is the Lossnay Core, a heat-exchange unit that transfers heat efficiently, cutting ventilation load by as much as 70%. A remarkable product found nowhere else, this special combination of functionality and performance contained within a single unit ensures users ample comfort, good health, and energy savings.

GUF-RD type

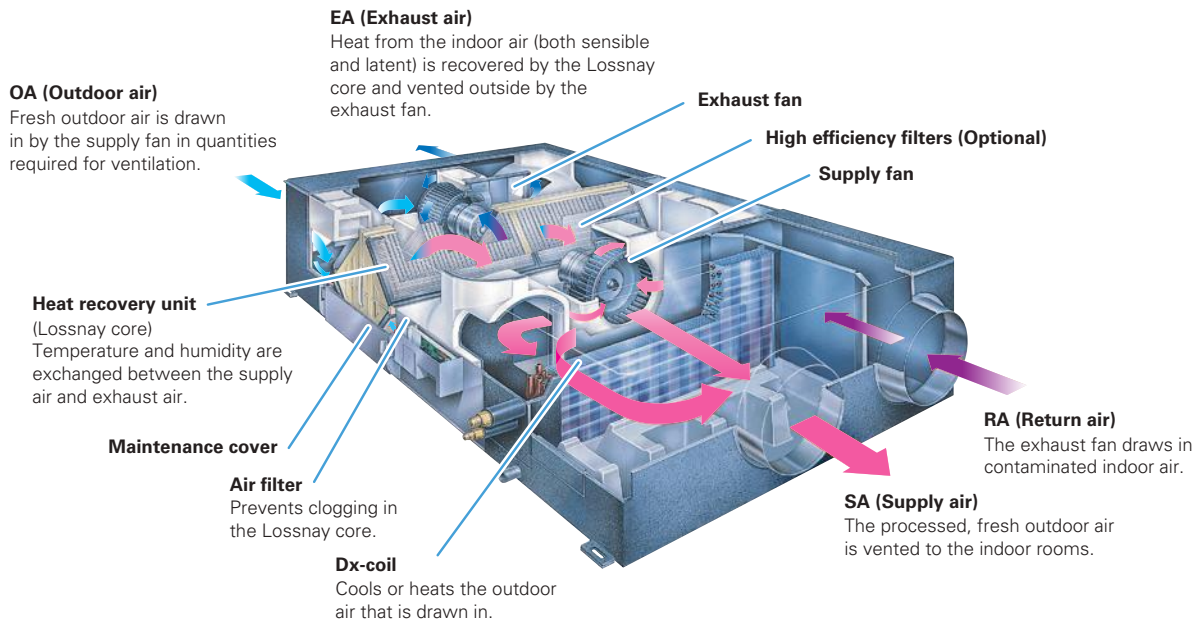

LGH-RVX3 SERIES

Specifications

LGH-15RVX3-E

Electrical power supply	220-240V/50Hz, 220V/60Hz				Test condition	
Fan speed	4	3	2	1		
Default Airflow setting	100%	75%	50%	25%	ISO 16494-1: 2022	
Input power (W)	55	30	15	10		
Airflow	(m ³ /h)	150	113	75		38
	(L/s)	42	31	21		10
Specific fan power [W/(L/s)]	1.32	0.96	0.72	0.96		
External static pressure (Pa)		120	68	30		8
	Temperature exchange efficiency (%)	Heating	73.5	75.5		78.0
	Cooling	65.5	70.5	73.5		78.0
Enthalpy exchange efficiency (%)	Heating	70.5	73.5	76.5		80.5
	Cooling	52.5	57.0	61.0		68.0
Noise (dB) <small>(Measured at 1.5m under the center of the unit in an anechoic chamber)</small>		27.0	22.0	18.0	17.0	A-weighted sound pressure level
Weight (kg)					20	

Characteristic Curves

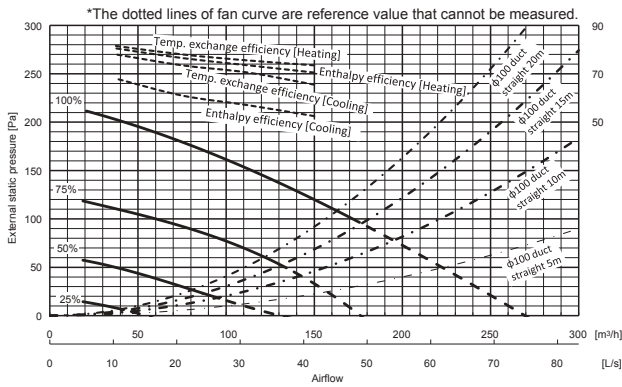

Dimensions

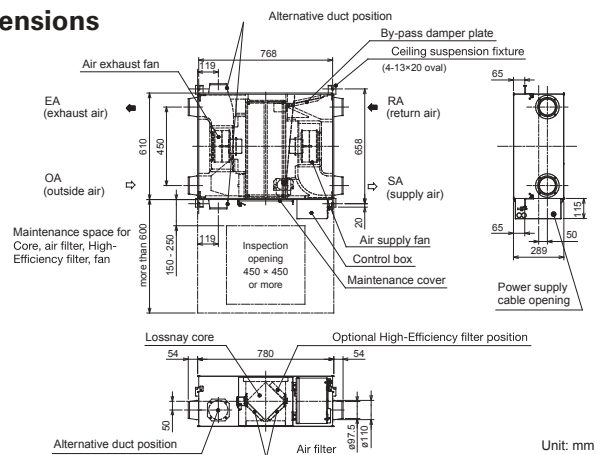

LGH-25RVX3-E

Electrical power supply	220-240V/50Hz, 220V/60Hz				Test condition	
Fan speed	4	3	2	1		
Default Airflow setting	100%	75%	50%	25%	ISO 16494-1: 2022	
Input power (W)	75	42	21	11		
Airflow	(m ³ /h)	250	188	125		63
	(L/s)	69	52	35		17
Specific fan power [W/(L/s)]	1.08	0.81	0.60	0.63		
External static pressure (Pa)		120	68	30		8
	Temperature exchange efficiency (%)	Heating	75.5	78.5		81.0
	Cooling	70.5	76.5	79.0		85.0
Enthalpy exchange efficiency (%)	Heating	69.0	72.0	75.5		84.0
	Cooling	56.0	60.5	65.0		73.0
Noise (dB) <small>(Measured at 1.5m under the center of the unit in an anechoic chamber)</small>		30.5	25.0	19.5	17.0	A-weighted sound pressure level
Weight (kg)					22	

Characteristic Curves

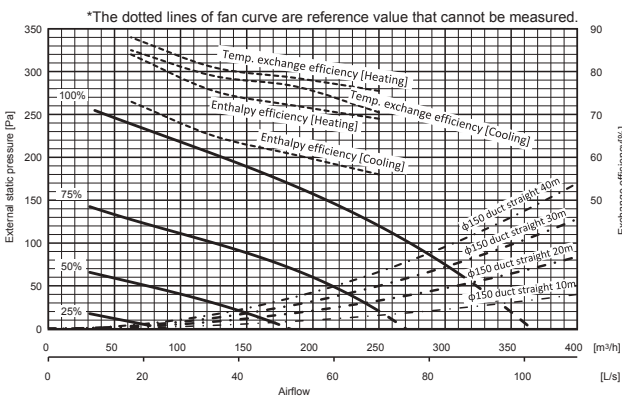

Dimensions

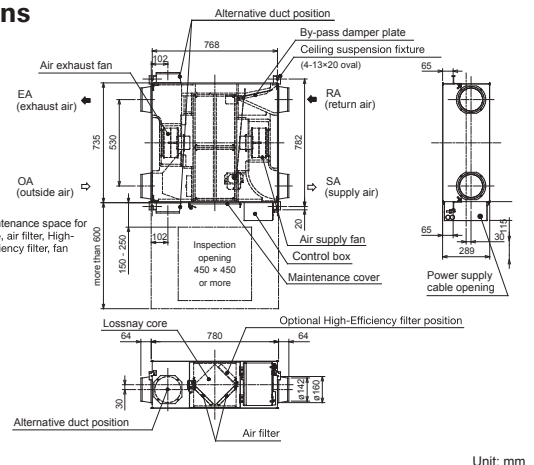

■ For LGH-RVX3 series

*The input power, the efficiency and the noise are based on the rating air volume, 230V/50Hz and horizontal installation.

LGH-35RVX3-E

Electrical power supply	220-240V/50Hz, 220V/60Hz				Test condition ISO 16494-1: 2022 A-weighted sound pressure level	
Fan speed	4	3	2	1		
Default Airflow setting	100%	75%	50%	25%		
Input power (W)	120	61	29	15		
Airflow	(m ³ /h)	350	263	175		88
	(L/s)	97	73	49		24
Specific fan power [W/(L/s)]	1.23	0.84	0.60	0.62		
External static pressure (Pa)	160	90	40	10		
Temperature exchange efficiency (%)	Heating	75.0	77.0	79.0		82.0
	Cooling	66.5	71.0	74.0		79.0
Enthalpy exchange efficiency (%)	Heating	72.0	74.5	77.5	80.0	
	Cooling	55.0	59.5	63.5	69.5	
Noise (dB) <small>(Measured at 1.5m under the center of the unit in an anechoic chamber)</small>	30.5	24.5	19.0	17.0		
Weight (kg)	30					

Characteristic Curves

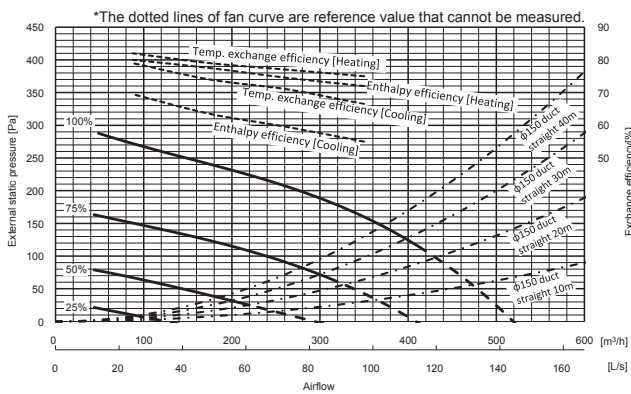

Dimensions

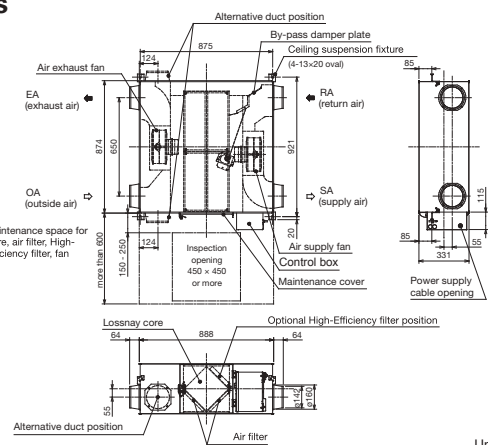

LGH-50RVX3-E

Electrical power supply	220-240V/50Hz, 220V/60Hz				Test condition ISO 16494-1: 2022 A-weighted sound pressure level	
Fan speed	4	3	2	1		
Default Airflow setting	100%	75%	50%	25%		
Input power (W)	185	81	34	15		
Airflow	(m ³ /h)	500	375	250		125
	(L/s)	139	104	69		35
Specific fan power [W/(L/s)]	1.33	0.78	0.49	0.43		
External static pressure (Pa)	150	85	38	10		
Temperature exchange efficiency (%)	Heating	70.5	71.5	73.5		75.0
	Cooling	63.5	67.0	71.0		73.0
Enthalpy exchange efficiency (%)	Heating	68.5	69.5	72.0	73.0	
	Cooling	51.5	55.0	60.0	65.0	
Noise (dB) <small>(Measured at 1.5m under the center of the unit in an anechoic chamber)</small>	35.0	27.0	21.0	17.0		
Weight (kg)	33					

Characteristic Curves

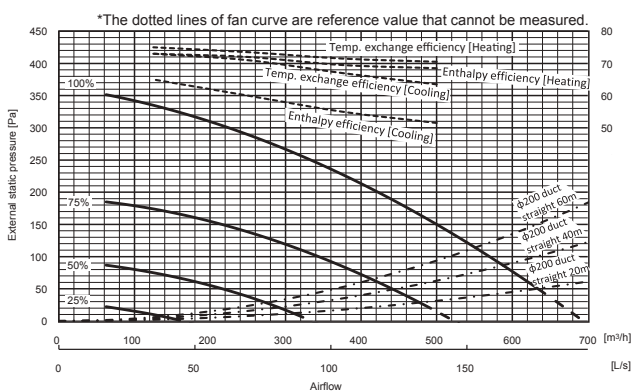

Dimensions

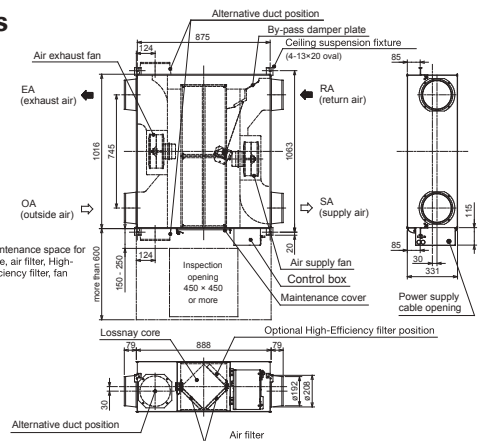

■ For LGH-RVX3 series

*The input power, the efficiency and the noise are based on the rating air volume, 230V/50Hz and horizontal installation.

LGH-65RVX3-E

Electrical power supply	220-240V/50Hz, 220V/60Hz				Test condition	
Fan speed	4	3	2	1		
Default Airflow setting	100%	75%	50%	25%	EN13053: 2019	
Input power (W)	245	120	51	20		
Airflow	(m ³ /h)	650	488	325		163
	(L/s)	181	135	90		45
Specific fan power [W/(L/s)]	1.36	0.89	0.56	0.44	EN308: 2022	
External static pressure (Pa)	150	85	38	10		
Temperature exchange efficiency (%)	Heating	72.5	75.0	78.5		82.0
	Cooling	65.0	70.0	74.5		80.0
Enthalpy exchange efficiency (%)	Heating	69.5	72.0	76.5		80.0
	Cooling	50.5	55.0	61.5		69.0
Noise (dB) <small>(Measured at 1.5m under the center of the unit in an anechoic chamber)</small>	37.5	31.5	24.0	17.5	A-weighted sound pressure level	
Weight (kg)					41	

Characteristic Curves

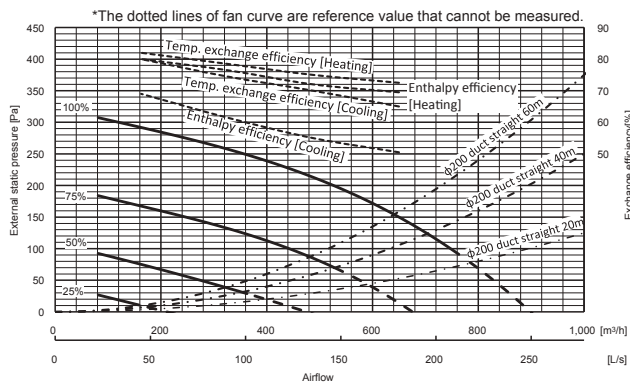

Dimensions

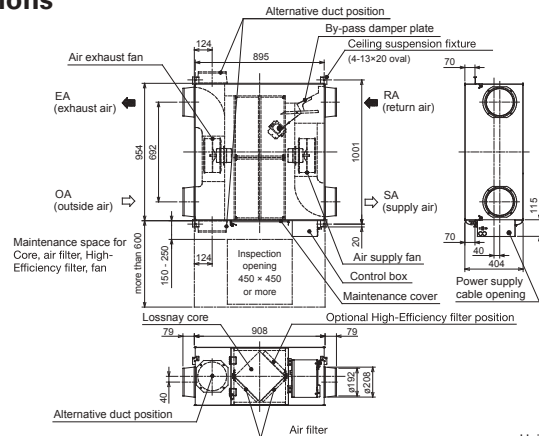

Unit: mm

LGH-80RVX3-E

Electrical power supply	220-240V/50Hz, 220V/60Hz				Test condition	
Fan speed	4	3	2	1		
Default Airflow setting	100%	75%	50%	25%	EN13053: 2019	
Input power (W)	343	160	64	23		
Airflow	(m ³ /h)	800	600	400		200
	(L/s)	222	167	111		56
Specific fan power [W/(L/s)]	1.54	0.96	0.58	0.41	EN308: 2022	
External static pressure (Pa)	170	96	43	11		
Temperature exchange efficiency (%)	Heating	75.0	76.5	78.0		80.0
	Cooling	65.0	70.0	75.5		78.0
Enthalpy exchange efficiency (%)	Heating	62.0	65.0	70.5		73.5
	Cooling	52.0	56.0	62.5		68.0
Noise (dB) <small>(Measured at 1.5m under the center of the unit in an anechoic chamber)</small>	39.0	33.5	25.0	18.0	A-weighted sound pressure level	
Weight (kg)					47	

Characteristic Curves

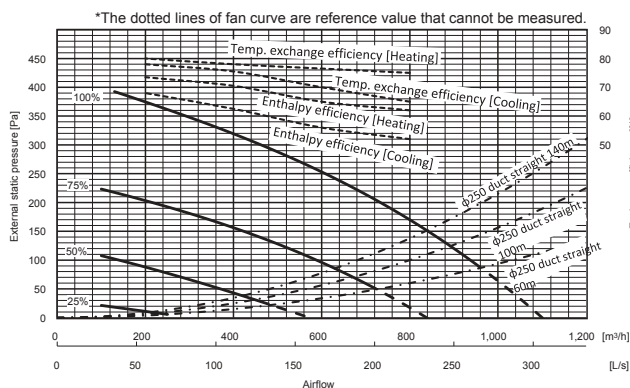

Dimensions

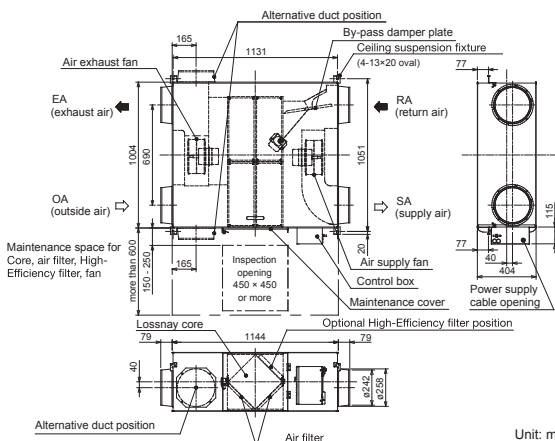

Unit: mm

■ For LGH-RVX3 series

*The input power, the efficiency and the noise are based on the rating air volume, 230V/50Hz and horizontal installation.

LGH-100RVX3-E

Electrical power supply	220-240V/50Hz, 220V/60Hz				Test condition	
Fan speed	4	3	2	1		
Default Airflow setting	100%	75%	50%	25%	EN13053: 2019	
Input power (W)	438	210	83	27		
Airflow	(m ³ /h)	1000	750	500		250
	(L/s)	278	208	139		69
Specific fan power [W/(L/s)]	1.58	1.01	0.60	0.39	EN308: 2022	
External static pressure (Pa)	190	107	48	12		
Temperature exchange efficiency (%)	Heating	75.5	77.0	79.5		83.5
	Cooling	67.5	72.0	77.0		82.5
Enthalpy exchange efficiency (%)	Heating	60.5	63.0	68.5	75.5	
	Cooling	53.5	59.0	64.0	71.5	
Noise (dB) <small>(Measured at 1.5m under the center of the unit in an anechoic chamber)</small>	40.0	35.0	27.0	18.5	A-weighted sound pressure level	
Weight (kg)					53	

Characteristic Curves

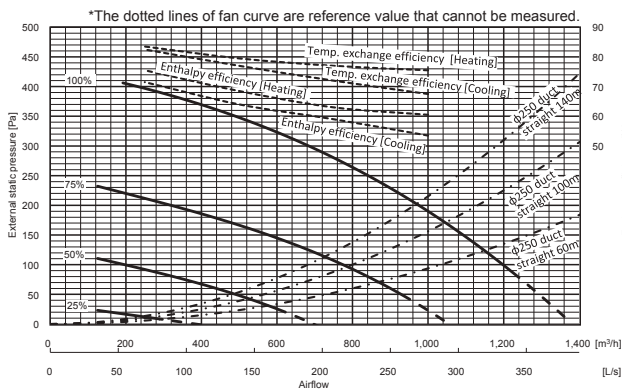

Dimensions

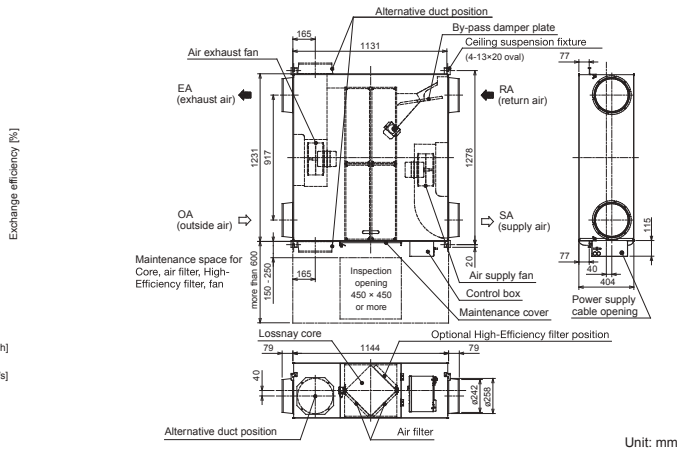

Unit: mm

LGH-160RVX3-E

Electrical power supply	220-240V/50Hz, 220V/60Hz				Test condition	
Fan speed	4	3	2	1		
Default Airflow setting	100%	75%	50%	25%	EN13053: 2019	
Input power (W)	687	324	128	45		
Airflow	(m ³ /h)	1600	1200	800		400
	(L/s)	444	333	222		111
Specific fan power [W/(L/s)]	1.55	0.97	0.58	0.41	EN308: 2022	
External static pressure (Pa)	170	96	43	11		
Temperature exchange efficiency (%)	Heating	75.0	76.5	78.0		80.0
	Cooling	65.0	70.0	75.5		78.0
Enthalpy exchange efficiency (%)	Heating	62.0	65.0	70.5	73.5	
	Cooling	52.0	56.0	62.5	68.0	
Noise (dB) <small>(Measured at 1.5m under the center of the unit in an anechoic chamber)</small>	41.0	35.0	26.0	18.0	A-weighted sound pressure level	
Weight (kg)					96	

Characteristic Curves

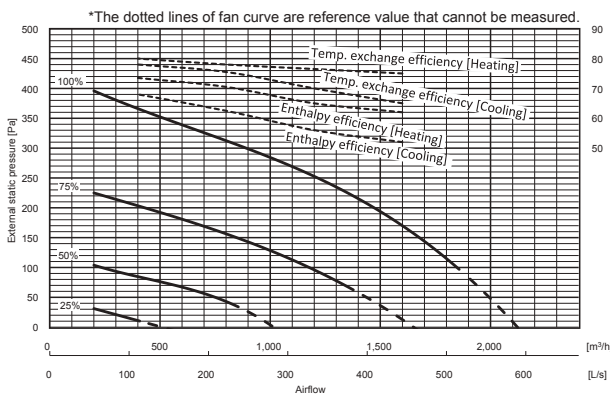

Dimensions

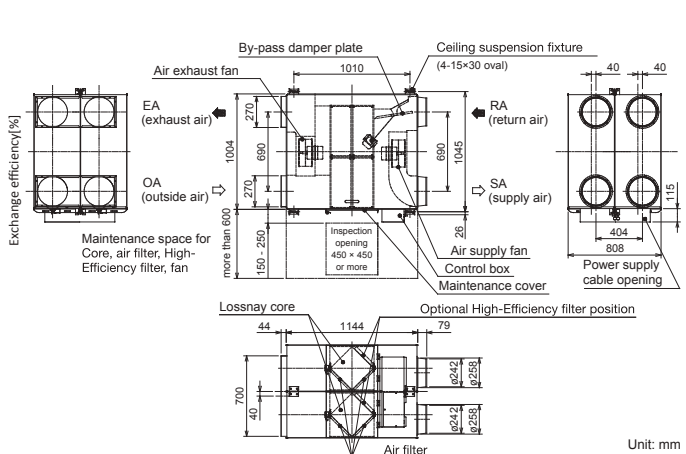

Unit: mm

■ For LGH-RVX3 series

*The input power, the efficiency and the noise are based on the rating air volume, 230V/50Hz and horizontal installation.

LGH-200RVXT-E

Electrical power supply		220-240V/50Hz, 220V/60Hz							
		Heat recovery mode				Bypass mode			
Ventilation mode									
Fan speed		SP4	SP3	SP2	SP1	SP4	SP3	SP2	SP1
Running current (A)		5.40	2.70	1.10	0.39	5.00	2.20	0.85	0.34
Input power (W)		1000	494	197	56	916	407	150	45
Airflow	(m ³ /h)	2000	1500	1000	500	2000	1500	1000	500
	(L/s)	556	417	278	139	556	417	278	139
External static pressure (Pa)	Supply	175	98	44	11	175	98	44	11
	Return	100	56	25	6	100	56	25	6
Temperature exchange efficiency (%)		80	81	82.5	84	-	-	-	-
Enthalpy exchange efficiency (%)	Heating	72.5	73.5	77	83	-	-	-	-
	Cooling	70	71	74.5	80.5	-	-	-	-
Noise (dB) (Measured at 1.5m under the center of the unit in an anechoic chamber)		39.5	35.5	28	22	40.5	34.5	27	20.5
Weight (kg)		159							

Characteristic Curves

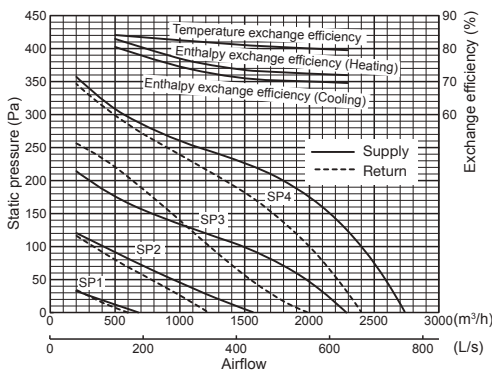

Dimensions

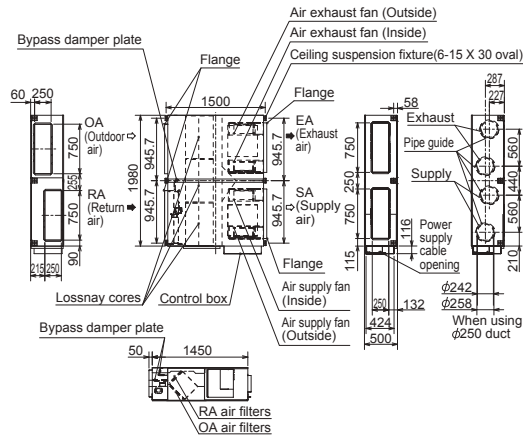

Unit: mm

LGH-250RVXT-E

Electrical power supply		220-240V/50Hz, 220V/60Hz							
		Heat recovery mode				Bypass mode			
Ventilation mode									
Fan speed		SP4	SP3	SP2	SP1	SP4	SP3	SP2	SP1
Running current (A)		7.60	3.60	1.40	0.57	6.90	3.10	1.30	0.49
Input power (W)		1446	687	244	82	1298	587	212	69
Airflow	(m ³ /h)	2500	1875	1250	625	2500	1875	1250	625
	(L/s)	694	521	347	174	694	521	347	174
External static pressure (Pa)	Supply	175	98	44	11	175	98	44	11
	Return	100	56	25	6	100	56	25	6
Temperature exchange efficiency (%)		77	79	80.5	82.5	-	-	-	-
Enthalpy exchange efficiency (%)	Heating	68	71.5	74	79	-	-	-	-
	Cooling	65.5	69	71.5	76.5	-	-	-	-
Noise (dB) (Measured at 1.5m under the center of the unit in an anechoic chamber)		43	39	32	24	44	38.5	31	22.5
Weight (kg)		198							

Characteristic Curves

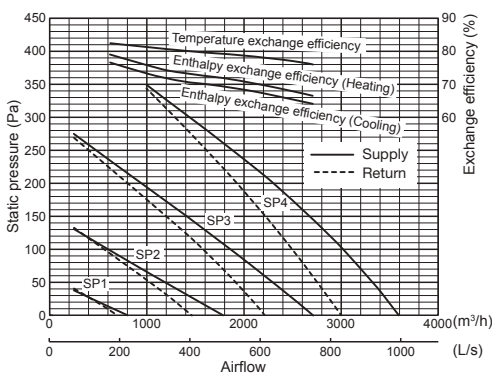

Dimensions

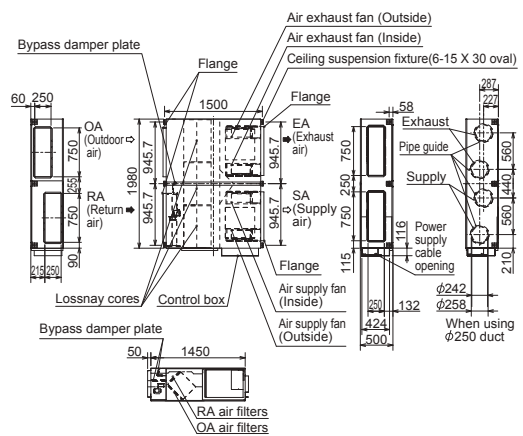

Unit: mm

■ For LGH-RVXT series

* The running current, the input power, the efficiency and the noise are based on the rated airflow, 230V/50Hz.

* Figures in the chart is measured according to Japan Industrial Standard (JIS B 8628). Characteristic Curves are measured by chamber method.

LGH-RVS SERIES

Specifications

LGH-50RVS-E

Weight	55kg (67kg with maximum drain water)					
Electrical power supply	220-240V/50Hz, 220V/60Hz					
Fan speed	100%	75%	50%	25%	Test condition	
Input power (W)	190	110	60	25		
Airflow	(m ³ /h)	500	375	250	125	ISO 16494 Temp. exchange efficiency is winter condition
	(L/s)	139	104	69	35	
Specific fan power [W/(L/s)]	1.37	1.06	0.86	0.72		
External static pressure (Pa)	150	84	38	9		
Temperature exchange efficiency (%)	87.0	89.0	91.0	93.0		
Noise (dB)	33.0	27.0	22.0	18.0	A-weighted sound pressure level @1.5m off from the center of the unit in an anechoic chamber Tracer gas method @100% airflow (prEN308)	
Exhaust air transfer ratio (%)	5					

Characteristic Curves

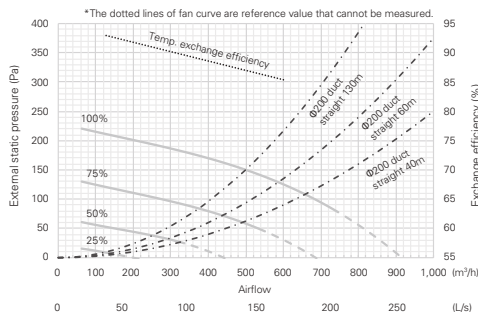

Dimensions

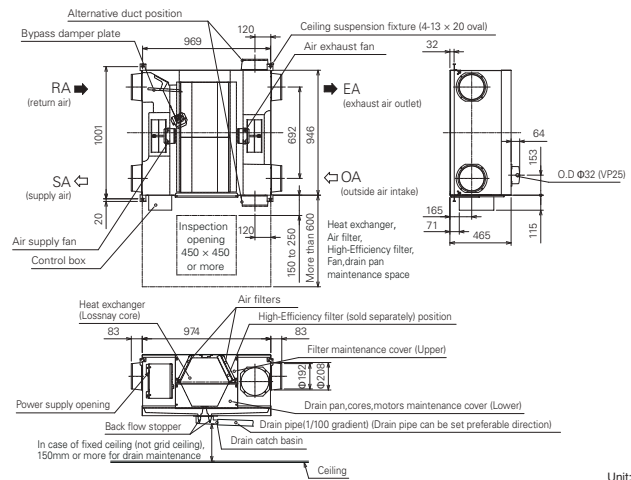

Unit: mm

LGH-80RVS-E

Weight	63kg (77kg with maximum drain water)					
Electrical power supply	220-240V/50Hz, 220V/60Hz					
Fan speed	100%	75%	50%	25%	Test condition	
Input power (W)	325	175	85	32		
Airflow	(m ³ /h)	800	600	400	200	ISO 16494 Temp. exchange efficiency is winter condition
	(L/s)	222	167	111	56	
Specific fan power [W/(L/s)]	1.46	1.05	0.77	0.58		
External static pressure (Pa)	170	96	43	11		
Temperature exchange efficiency (%)	82.0	84.0	86.0	90.0		
Noise (dB)	36.0	30.0	25.0	18.0	A-weighted sound pressure level @1.5m off from the center of the unit in an anechoic chamber Tracer gas method @100% airflow (prEN308)	
Exhaust air transfer ratio (%)	5					

Characteristic Curves

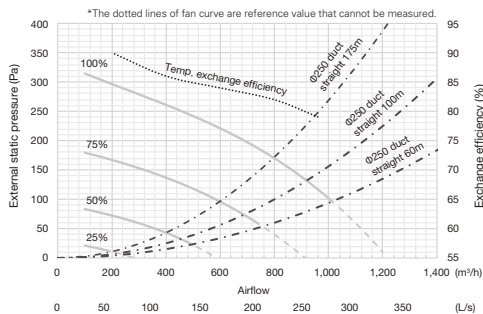

Dimensions

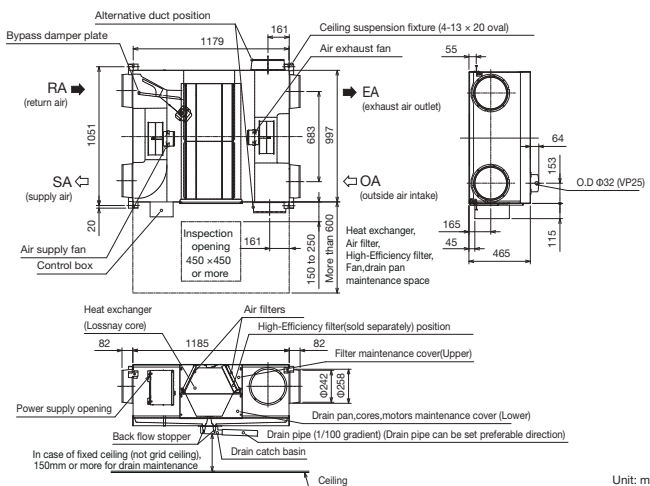

Unit: mm

■The input power, the efficiency and the noise are based on the rating airflow, and 230V/50Hz. Temperature exchange efficiency (%) is measured at indoor DB 20°C/WB15°C and outdoor DB 5°C/WB3°C. It is measured according to ISO16494.

■When the indoor humidity is low and condensation in the heat exchanger does not occur, the exchange efficiency may be decreased in winter.

■The absolute humidity of RA shall be lower than 0.0139kg/kg (DA) in winter and relative humidity of RA shall be lower than 90%RH through the year.

Example of the absolute humidity 0.0139kg/kg (DA) are 20.7°C 90%RH, 25°C 70%, 30°C 50% etc.

LGH-100RVS-E

Weight	73kg (89kg with maximum drain water)					
Electrical power supply	220-240V/50Hz, 220V/60Hz					
Fan speed	100%	75%	50%	25%	Test condition	
Input power (W)	445	225	100	35	ISO 16494 Temp. exchange efficiency is winter condition	
Airflow	(m ³ /h)	1000	750	500		250
	(L/s)	278	208	139		69
Specific fan power [W/(L/s)]	1.60	1.08	0.72	0.50		
External static pressure (Pa)	190	107	48	12		
Temperature exchange efficiency (%)	82.0	84.0	86.0	90.0		
Noise (dB)	37.0	32.0	24.0	18.0		
Exhaust air transfer ratio (%)	5				A-weighted sound pressure level @1.5m off from the center of the unit in an anechoic chamber Tracer gas method @100% airflow (prEN308)	

Characteristic Curves

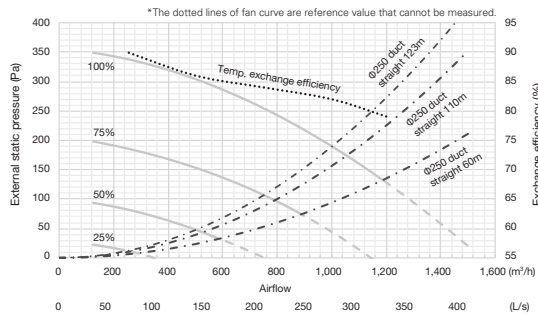

Dimensions

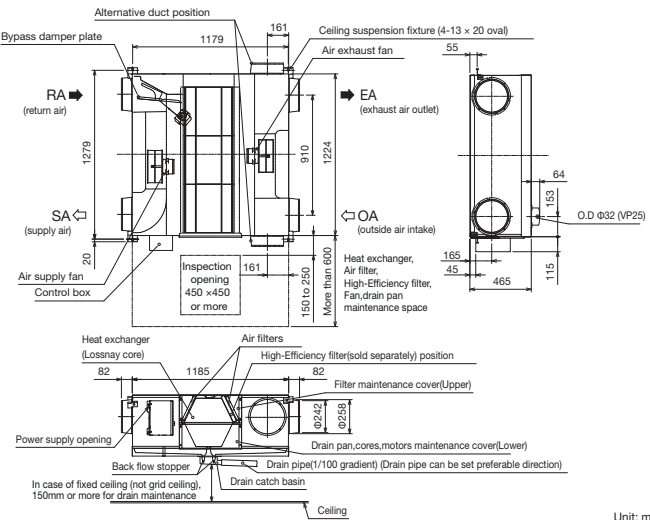

■ The input power, the efficiency and the noise are based on the rating airflow, and 230V/50Hz. Temperature exchange efficiency (%) is measured at indoor DB 20°C/WB15°C and outdoor DB 5°C/WB3°C. It is measured according to ISO16494.

When the indoor humidity is low and condensation in the heat exchanger does not occur, the exchange efficiency may be decreased in winter.

■ The absolute humidity of RA shall be lower than 0.0139kg/kg (DA) in winter and relative humidity of RA shall be lower than 90%RH through the year.

Example of the absolute humidity 0.0139kg/kg (DA) are 20.7°C 90%RH, 25°C 70%, 30°C 50% etc.

GU-F50RDH4

Electrical power supply	220-240V/50Hz			
Ventilation mode	Heat recovery mode		Bypass mode	
Fan speed	High	Low	High	Low
Running current (A)	1.15	0.70	1.15	0.70
Input power (W)	235-265	150-165	235-265	150-165
Airflow	(m ³ /h)	500	400	500
	(L/s)	139	111	139
External static pressure (Pa)	125	80	125	80
Temperature exchange efficiency (%)	77.5	80	-	-
Enthalpy exchange efficiency (%)	Heating	68	71	-
	Cooling	65	67	-
Cooling capacity (kW)	5.57 (1.94)			
Heating capacity (kW)	6.21 (2.04)			
Capacity equivalent to the indoor unit	P32			
Humidifier	Humidifying	Permeable film humidifier		
	Humidifying capacity (kg/h)	2.7 (heating)		
	Water supply pressure	Minimum pressure : 2.0 × 10 ⁴ Pa Maximum pressure : 49.0 × 10 ⁴ Pa		
Noise (dB) (Measured at 1.5m under the center of the unit in an anechoic chamber)	33.5-34.5	29.5-30.5	35-36	29.5-30.5
Weight (kg)	51 (filled with water 55)			

Characteristic Curves

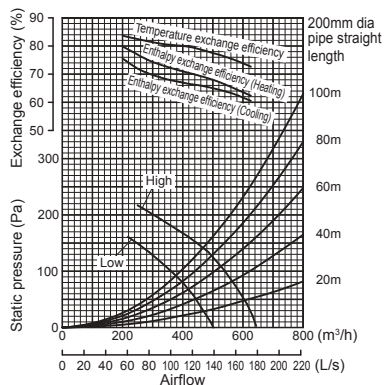

Dimensions

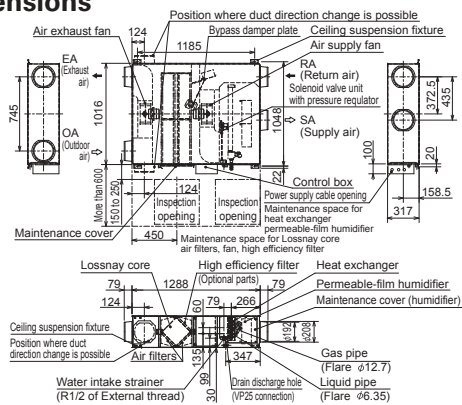

Unit: mm

GU-F100RDH4

Electrical power supply	220-240V/50Hz			
Ventilation mode	Heat recovery mode		Bypass mode	
Fan speed	High	Low	High	Low
Running current (A)	2.20	1.76	2.25	1.77
Input power (W)	480-505	385-400	490-515	385-410
Airflow	(m ³ /h)	1000	800	1000
	(L/s)	278	222	278
External static pressure (Pa)	135	86	135	86
Temperature exchange efficiency (%)	79.5	81.5	-	-
Enthalpy exchange efficiency (%)	Heating	71	74	-
	Cooling	69	71	-
Cooling capacity (kW)	11.44 (4.12)			
Heating capacity (kW)	12.56 (4.26)			
Capacity equivalent to the indoor unit	P63			
Humidifier	Humidifying	Permeable film humidifier		
	Humidifying capacity (kg/h)	5.4 (heating)		
	Water supply pressure	Minimum pressure : 2.0 × 10 ⁴ Pa Maximum pressure : 49.0 × 10 ⁴ Pa		
Noise (dB) (Measured at 1.5m under the center of the unit in an anechoic chamber)	38-39	34-35	38-39	35-36
Weight (kg)	88 (filled with water 96)			

Characteristic Curves

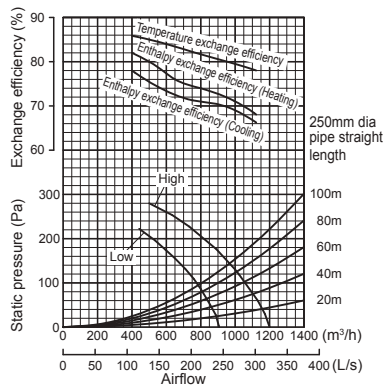

Dimensions

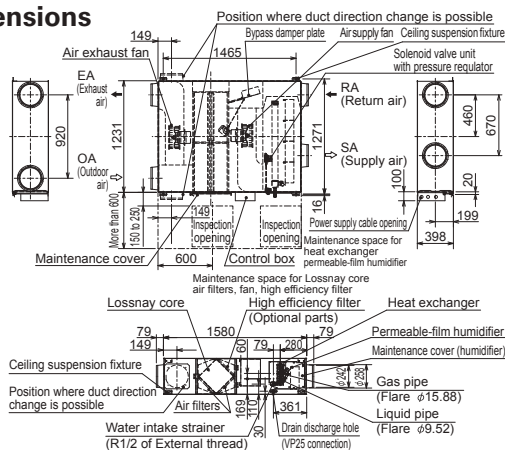

Unit: mm

■ For GUF series

*Cooling/Heating capacity indicates the maximum value at operation under the following condition.

Cooling: Indoor: 27°C DB/19°C WB Outdoor: 35°C DB/24°C WB

Heating: Indoor: 20°C DB/13.8°C WB Outdoor: 7°C DB/6°C WB

*The figures in () indicates heat recovery capacity of heat exchanger core.

*Figures in the chart are measured according to Japan Industrial Standard (JIS B 8628). Characteristic Curves are measured by chamber method.

*When the total capacity of indoor units connected to 1 outdoor units (PUHY or PURY) exceeds the capacity of the total unit, the total capacity of GUF needs to be 30% and less of the connected outdoor unit capacity.

CONTROL TECHNOLOGIES

New model





PZ-62DR-EA/EB

Multi-language Display

Control panel operation in 17 different languages. Choose a desired language, among the following languages.

	-EA	-EB	
Language	English	●	●
	German	●	●
	Spanish	●	●
	French	●	●
	Italian		●
	Russian	●	
	Portuguese		●
	Swedish		●
	Dutch	●	
	Turkish	●	
	Polish	●	
	Greek		●
	Czech	●	
	Hungarian	●	
	Slovenian		●
	Bulgarian	●	
	Danish		●

Compatibility Table

Remote Controller Compatibility Table			
Model name	PZ-62DR-EA/EB		PZ-43SMF-E
Appearance			
Compatible series	LGH-RVX3/RVS	LGH-RVXT	LGH-RVX3/RVXT/RVS
Fan speed selection	4 fan speeds and Auto (Auto is available when using a CO ₂ sensor)	4 fan speeds	2 of 4 fan speeds
Control with a CO ₂ sensor (Mitsubishi Electric)	Yes (Fan speed automatically changes from 25% to 100% depending on the CO ₂ concentration*)	No	No
Control with a CO ₂ sensor (field supply)	Yes (Fan speed automatically changes from 25% to 100% depending on the CO ₂ concentration*)	Yes (Fan speed automatically changes 4 levels depending on the CO ₂ concentration*)	No
Ventilation mode selection	Energy recovery/Bypass/Auto	Energy recovery/Bypass/Auto	Energy recovery/Bypass/Auto
Night-purge	Yes	Yes	No
Function setting from remote controller	Yes	Yes	No
Bypass temp. free setting	Yes	Yes (Set in Function setting menu)	No
Multi-stage airflow control	Yes (Both supply and exhaust fan speeds can be set separately from 25% to 100% in 5% pitches)	No	No
ON/OFF timer	Yes	Yes	Yes
Auto-off timer	Yes	Yes	No
Weekly timer	Yes	Yes	No
Fan speed timer	Yes	Yes	No
Operation restrictions (ON/OFF, ventilation mode, fan speed)	Yes	Yes	No
Operation restrictions (fan speed skip setting)	Yes	Yes	No
Screen contrast adjustment	Yes	Yes	No
Language selection*	Yes (17 languages)	Yes (17 languages)	No (English only)
CO ₂ concentration indication	Yes (available when using a Mitsubishi Electric CO ₂ sensor)	No	No
Filter cleaning sign	Yes (Maintenance interval can be changed)	Yes	Yes
LOSSNAY core cleaning sign	Yes/No (RVS series)	Yes	No
Error indication	Yes (Displays model name, serial number, contact information)	Yes (Displays model name, serial number, contact information)	Yes
Error history	Yes	Yes	No
OA/RA/SA temp. display	Yes	Yes	No

*When using a CO₂ sensor. Upper and lower limits may be changed.

Filters & Accessories

Filters For LGH-RVX3 Series

PZ-**RF3-E Standard filter



Filter					LOSSNAY		
Filter material	Installation position	Classification		Model name	Piece/set included	Applicable model	Required set/unit
		ISO16890:2016	EN779:2012				
Non-woven fabric	Before HEX	Coarse 60%	—	PZ-15RF3-E	2	LGH-15RVX3-E	1
				PZ-25RF3-E	2	LGH-25RVX3-E	1
				PZ-35RF3-E	2	LGH-35RVX3-E	1
				PZ-50RF3-E	2	LGH-50RVX3-E	1
				PZ-65RF3-E	2	LGH-65RVX3-E	1
				PZ-80RF3-E	2	LGH-80RVX3-E	1
					2	LGH-160RVX3-E	2
PZ-100RF3-E	2	LGH-100RVX3-E	1				
		LGH-200RVX3-E	2				

PZ-**RFP3-E ePM1 75% filter



Filter					LOSSNAY		
Filter material	Installation position	Classification		Model name	Piece/set included	Applicable model	Required set/unit
		ISO16890:2016	EN779:2012				
Pleated filter	After HEX	ePM1 75%	—	PZ-15RFP3-E	1	LGH-15RVX3-E	1
				PZ-25RFP3-E	2	LGH-25RVX3-E	1
				PZ-35RFP3-E	2	LGH-35RVX3-E	1
				PZ-50RFP3-E	2	LGH-50RVX3-E	1
				PZ-65RFP3-E	2	LGH-65RVX3-E	1
				PZ-80RFP3-E	2	LGH-80RVX3-E	1
					2	LGH-160RVX3-E	2
PZ-100RFP3-E	2	LGH-100RVX3-E	1				
		LGH-200RVX3-E	2				

PZ-**RFM3-E M6 filter



Filter					LOSSNAY		
Filter material	Installation position	Classification		Model name	Piece/set included	Applicable model	Required set/unit
		ISO16890:2016	EN779:2012				
Pleated filter	Before HEX	—	M6	PZ-15RFM3-E	1	LGH-15RVX3-E	1
				PZ-25RFM3-E	2	LGH-25RVX3-E	1
				PZ-35RFM3-E	2	LGH-35RVX3-E	1
				PZ-50RFM3-E	2	LGH-50RVX3-E	1
				PZ-65RFM3-E	2	LGH-65RVX3-E	1
				PZ-80RFM3-E	2	LGH-80RVX3-E	1
					2	LGH-160RVX3-E	2
PZ-100RFM3-E	2	LGH-100RVX3-E	1				
		LGH-200RVX3-E	2				

PZ-**RFH3-E F8 filter



Filter					LOSSNAY		
Filter material	Installation position	Classification		Model name	Piece/set included	Applicable model	Required set/unit
		ISO16890:2016	EN779:2012				
Pleated filter	After HEX	—	F8	PZ-15RFH3-E	1	LGH-15RVX3-E	1
				PZ-25RFH3-E	2	LGH-25RVX3-E	1
				PZ-35RFH3-E	2	LGH-35RVX3-E	1
				PZ-50RFH3-E	2	LGH-50RVX3-E	1
				PZ-65RFH3-E	2	LGH-65RVX3-E	1
				PZ-80RFH3-E	2	LGH-80RVX3-E	1
					2	LGH-160RVX3-E	2
PZ-100RFH3-E	2	LGH-100RVX3-E	1				
		LGH-200RVX3-E	2				

Filters For LGH-RVXT Series & GUF Series

Standard Filters

Replacements for the standard filter supplied with the LOSSNAY main unit.



Filter Material	Filter			LOSSNAY		
	Classification		Model Name	Included piece/set	Applicable model	Required filter pieces
	ISO16890:2016	EN779:2012				
Non-woven fabric	Coarse 35%	G3*	PZ-50RFa-E	4	GUF-50RD4, GUF-50RDH4	4
			PZ-100RFa-E	4	GUF-100RD4, GUF-100RDH4	4
	Coarse 50%	G3	PZ-150RTF-E	4	LGH-150RVXT-E	4
			PZ-250RTF-E	4	LGH-200RVXT-E, LGH-250RVXT-E	4

*The classification in EN779 (2002) is G3.

High-efficiency Filters Optional

These high-efficiency filters can be easily inserted in the LOSSNAY unit without the need to attach external parts.



Filter Material	Filter			LOSSNAY		
	Classification		Model Name	Included piece/set	Applicable model	Required filter pieces
	ISO16890:2016	EN779:2012				
Synthetic fiber	ePM ₁₀ 75%	M6*	PZ-50RFM-E	2	GUF-50RD4, GUF-50RDH4	2
			PZ-100RFM-E	2	GUF-100RD4, GUF-100RDH4	2

*The classification in EN779 (2002) is F7.

Advanced High-efficiency Filters (For GUF Series) Optional

These advanced high-efficiency filters are designed to remove approx. 99.7% of airborne particulates that are 0.5µm or larger.

*GB/T14295-2008 : YG class, 99.7% (Collecting efficiency for particles that are 0.5µm or larger)



Filter Material	Filter			LOSSNAY		
	Classification		Model Name	Included piece/set	Applicable model	Required filter pieces
	ISO16890:2016	EN779:2012				
Synthetic fiber	ePM ₁ 75% ePM _{2.5} 80% ePM ₁₀ 95%	—	PZ-50RFPz-E	2	GUF-50RD4, GUF-50RDH4	2
			PZ-100RFPz-E	2	GUF-100RD4, GUF-100RDH4	2

Advanced High-efficiency Filters (For LGH-RVXT Series) Optional

These advanced high-efficiency filters can be easily inserted in the LOSSNAY unit without the need to attach external parts.



Filter Material	Filter			LOSSNAY		
	Classification		Model Name	Included piece/set	Applicable model	Required filter pieces
	ISO16890:2016	EN779:2012				
Non-woven fabric	ePM ₁₀ 75%	M6*	PZ-M6RTFM-E	3	LGH-150RVXT-E, LGH-200RVXT-E, LGH-250RVXT-E	3
			PZ-F8RTFM-E	3		
	ePM ₁ 65% ePM _{2.5} 75% ePM ₁₀ 90%	F8*	PZ-M6TDF-E	3		
			PZ-F8TDF-E	3		

*There is no data for the classification in EN779 (2002).

Filters For LGH-RVS Series

Filters

A lineup of three types of filters offers optimum indoor air quality solutions!
All filters are ISO and EN779:2012 certified, and can be easily installed in the units.
Maintenance and exchanges can also be performed easily, simply by opening the maintenance panel.

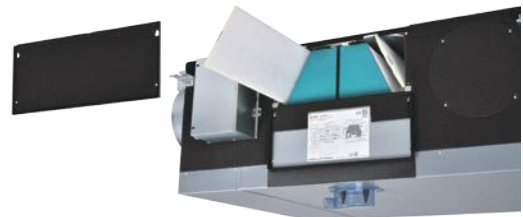

Standard Filter



Filter material	Filter			LOSSNAY		
	Classification		Model name	Included piece/set	Applicable model	Required set/unit
	ISO 16890 (2016)	EN779 (2012)				
Non-woven fabrics	Coarse 50%	G3	PZ-S50RF-E	2	LGH-50RVS-E	1
			PZ-S80RF-E	2	LGH-80RVS-E	1
			PZ-S100RF-E	2	LGH-100RVS-E	1

High-efficiency Filter



Filter material	Filter			LOSSNAY		
	Classification		Model name	Included piece/set	Applicable model	Required set/unit
	ISO 16890 (2016)	EN779 (2012)				
Pleated filter	ePM ₁₀ 80%	M6	PZ-S50RFM-E	2	LGH-50RVS-E	1
			PZ-S80RFM-E	2	LGH-80RVS-E	1
			PZ-S100RFM-E	2	LGH-100RVS-E	1

Advanced High-efficiency Filter



Filter material	Filter			LOSSNAY		
	Classification		Model name	Included piece/set	Applicable model	Required set/unit
	ISO 16890 (2016)	EN779 (2012)				
Pleated filter	ePM ₁₀ 90% ePM _{2.5} 75% ePM ₁ 65%	F8	PZ-S50RFH-E	2	LGH-50RVS-E	1
			PZ-S80RFH-E	2	LGH-80RVS-E	1
			PZ-S100RFH-E	2	LGH-100RVS-E	1

Accessories For LGH-RVX3/RVS Series

CO₂ Sensor

A CO₂ sensor connected directly to a LOSSNAY RVX3/RVS unit optimizes the fan speed according to the level of CO₂ detected. It improves total heat exchange efficiency and contributes to energy saving.

PZ-70CSW-E

(Wall-mounted type)

CO₂ levels are indicated by LED lights.



PZ-70CSD-E

(Duct-mounted type)



Automatic operation with CO₂ sensor

Fan speed automatically changes depending on CO₂ concentration.

Accessories For LGH-RVX3/RVS Series & GUF Series

Duct Silencer

In facilities and applications requiring quiet operations, the silencer duct that reduces noise levels is the ideal solution. It contains glass wool and attenuates sound power by absorbing the noise from the airflow or operation of the unit.



Specifications

Model	Airflow [m ³ /h]	Attenuation of sound power level [dB] for center frequency (Discharge)							
		62.5Hz	125Hz	250Hz	500Hz	1000Hz	2000Hz	4000Hz	8000Hz
PZ-100SS-E	50	0	3	5	7	6	6	6	8
	150	0	3	6	7	7	7	7	9
PZ-150SS-E	250	0	1	5	8	15	21	20	14
	350	0	1	4	8	14	21	21	16
PZ-200SS-E	500	0	1	4	7	13	18	16	9
	650	0	1	3	8	12	17	14	6
PZ-250SS-E	800	0	2	4	12	22	21	14	13
	1000	0	1	4	12	22	20	14	13

1. Figures on the chart above are based on the comparison with a general steel duct of the same length.
2. The silencer is placed on just before the outlet during the measurement.
3. When the airflow rate differs, the insertion loss is also different from the chart above.
4. Figures on the chart above are flat (No-weighted) values.

Dimensions

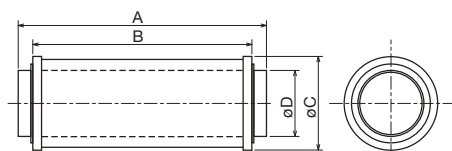

Model	A	B	C	D	Connecting duct	Weight (kg)
PZ-100SS-E	450	400	152	99	ø100	1.9
PZ-150SS-E	560	500	202	149	ø150	3.5
PZ-200SS-E	660	600	252	199	ø200	5.3
PZ-250SS-E	660	600	332	249	ø250	8.9

Unit: mm

VL-CZPVU SERIES

Vertical type centralized ventilation with sensible heat exchange for residential use.

VL-250CZPVU-R/L-E
VL-350CZPVU-R/L-E
VL-500CZPVU-R/L-E



Key features



Quiet Operation

Noise is one of the most common concerns for residential ventilation. Ultra quiet operation is achieved with the sirocco fan designed by Mitsubishi Electric. The balance between airflow and static pressure is optimized and the fan rotation is minimized, leading to low noise levels.

Air Purification

An optional filter removes NO_x and PM2.5 and improves indoor air quality. They can be incorporated inside the unit without any filter box, which saves space.

*NO_x: Nitrogen oxide, which includes nitric oxide (NO) and nitrogen dioxide (NO₂).
*PM2.5: Airborne particulates that are 2.5µm or smaller in size.

Wi-Fi Control

MELCloud is a Cloud-based solution for controlling LOSSNAY units either locally or remotely by computer, tablet or smartphone via the Internet. It allows LOSSNAY operations to be checked and controlled via MELCloud from virtually anywhere and Internet connection is available. With MELCloud, the LOSSNAY system can be used much more easily and conveniently.

Energy efficiency

Under regulation (EU) No. 1254/2014, the VL-CZPVU series has the highest energy-saving performance in its class (ErP A⁺). It saves heating and cooling costs by minimizing the energy loss that occurs during ventilation.

ErP A⁺

A⁺

Variable airflow control

The default fan speed value (Fan speed 1: 30%, Fan speed 2: 50%, Fan speed 3: 70%, and Fan speed 4: 100%) of both supply air and exhaust air can be adjusted flexibly. Within the range between 25% and 100%, airflow can be adjusted by 1% increments to satisfactorily meet the designed airflow rate.

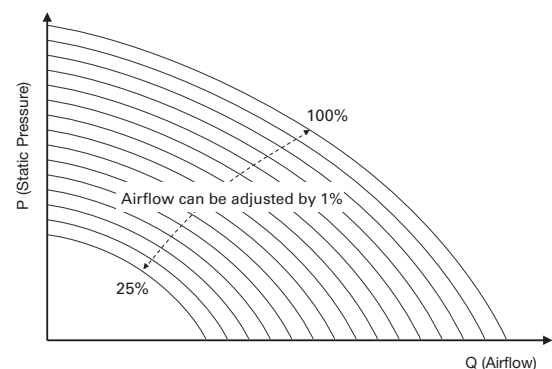

External airflow control

The airflow from the LOSSNAY unit can be altered using 0-10V signals from the controllers, such as the humidity stat and CO₂ sensor (field supply). The LOSSNAY unit is also connected to the light switch and can change to boost operation mode (input 220-240V). These devices are connected directly to the LOSSNAY unit, allowing automatic fan speed control according to bathroom occupation, CO₂ level, and humidity level.

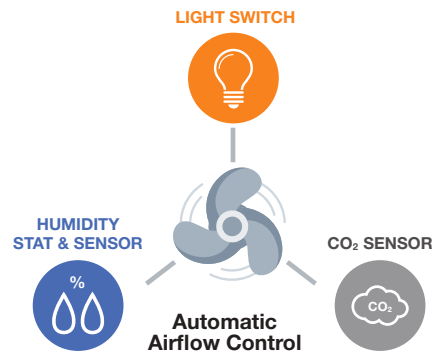

Automatic bypass mode

It is possible to switch between "LOSSNAY ventilation (with heat exchange)" and "Bypass ventilation (without heat exchange)" either manually or automatically. When outside air is cooler than indoor air in summer, the unit directly draws in outside air, bypassing the heat exchanger.

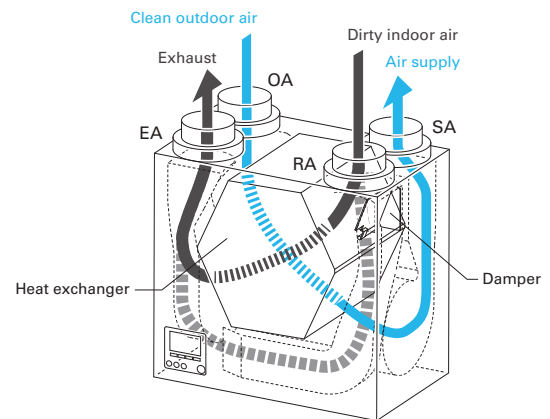

* The figure shows VL-350CZPVU-L-E

Wide operating temperature range

The VL-CZPVU series can operate at temperatures down to -15°C . With a pre-heater, it can operate at temperatures down to -25°C .

* In areas where outdoor air falls below -20°C , an electric shutter (locally supplied) is required in the OA duct in addition to the pre-heater.

* The OA temperature must be higher than -15°C to use the pre-heater.

MELCloud for LOSSNAY

MELCloud enables fast, easy remote control and monitoring of LOSSNAY units. Wireless computer connectivity and an Internet-connected mobile or fixed terminal are all that are needed. MELCloud can also be used to control room air conditioners and Ecodan heat pumps simultaneously.

Key Control and Monitoring Features

1. Turn system on/off
2. Switching airflow & operating mode (Heat recovery / Bypass)
3. Confirming the status of the filter/core (Maintenance notification)



VL-CZPVU SERIES

Specifications

VL-250CZPVU-R/L-E

Electrical Power Supply	220-240V/50Hz, 220V-/60Hz				
Ventilation Mode	Heat recovery mode				
Fan Speed	FS4 (100%)	FS3 (70%)	FS2 (50%)	FS1 (30%)	
Running Current (A)	0.76	0.35	0.20	0.12	
Input Power (W)	106	44	23	11	
Airflow	(m ³ /h)	250	175	125	75
	(L/s)	69	49	35	21
External Static Pressure (Pa)	150	74	38	14	
Temperature Exchange Efficiency (%)	85	87	88	90	
Noise Level (dB)	31	22	16	15 >	
Energy Efficiency Class	A+				
Weight (kg)	26				
Dimensions (mm)	(H) 565 x (W) 595 x (D) 356				

■ Attention

1. The above values are at factory default.
2. The running current, the input power, the efficiency and the noise are based on the rating airflow, and 230V/50Hz.
3. The sound pressure level at 3m is spherical.
4. Temperature exchange efficiency (%) is based on winter condition.
5. Mitsubishi Electric measures figures in the chart according to EN13141-7: 2010, and the characteristic curves are measured by chamber method.

Characteristic Curves

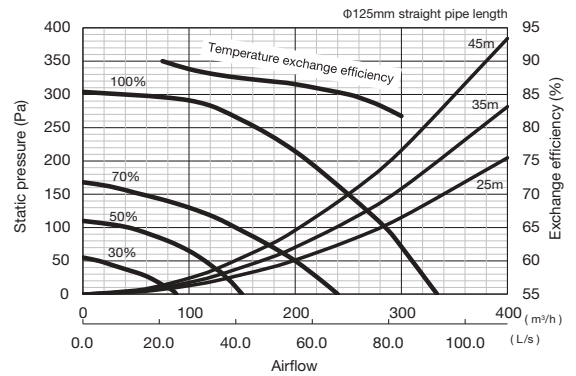

■ Attention

Mitsubishi Electric measures figures in the chart according to EN13141-7: 2010, and the characteristic curves are measured by chamber method.

Dimensions

VL-250CZPVU-R-E

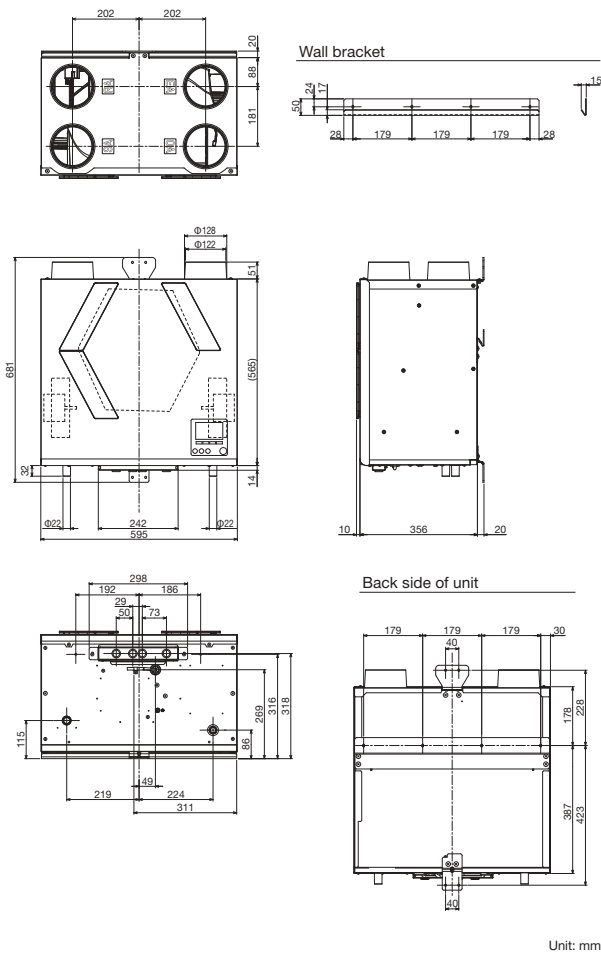

VL-250CZPVU-L-E

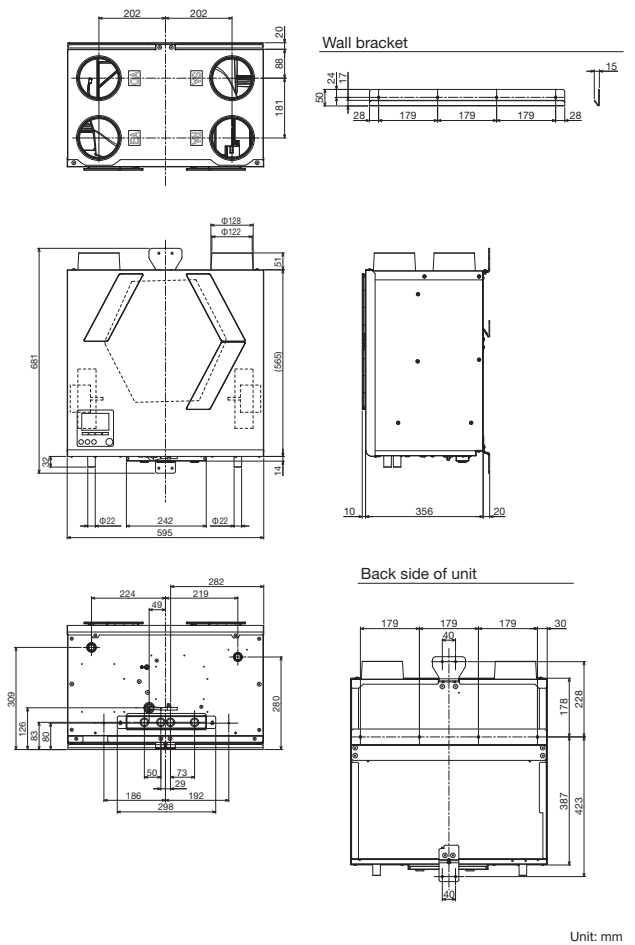

VL-350CZPVU-R/L-E

Electrical Power Supply	220-240V/50Hz, 220V-/60Hz				
Ventilation Mode	Heat recovery mode				
Fan Speed	FS4 (100%)	FS3 (70%)	FS2 (50%)	FS1 (30%)	
Running Current (A)	1.08	0.52	0.31	0.18	
Input Power (W)	155	71	37	19	
Airflow	(m³/h)	320	224	160	96
	(L/s)	89	62	44	27
External Static Pressure (Pa)	150	74	38	14	
Temperature Exchange Efficiency (%)	85	87	88	90	
Noise Level (dB)	35	26	19	15>	
Energy Efficiency Class	A+				
Weight (kg)	32				
Dimensions (mm)	(H) 623 x (W) 658 x (D) 432				

Attention

1. The above values are at factory default.
2. The running current, the input power, the efficiency and the noise are based on the rating airflow, and 230V/50Hz.
3. The sound pressure level at 3m is spherical.
4. Temperature exchange efficiency (%) is based on winter condition.
5. Mitsubishi Electric measures figures in the chart according to EN13141-7: 2010, and the characteristic curves are measured by chamber method.

Characteristic Curves

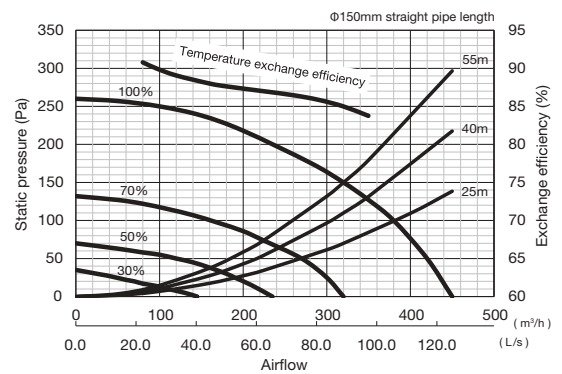

Attention

Mitsubishi Electric measures figures in the chart according to EN13141-7: 2010, and the characteristic curves are measured by chamber method.

Dimensions

VL-350CZPVU-R-E

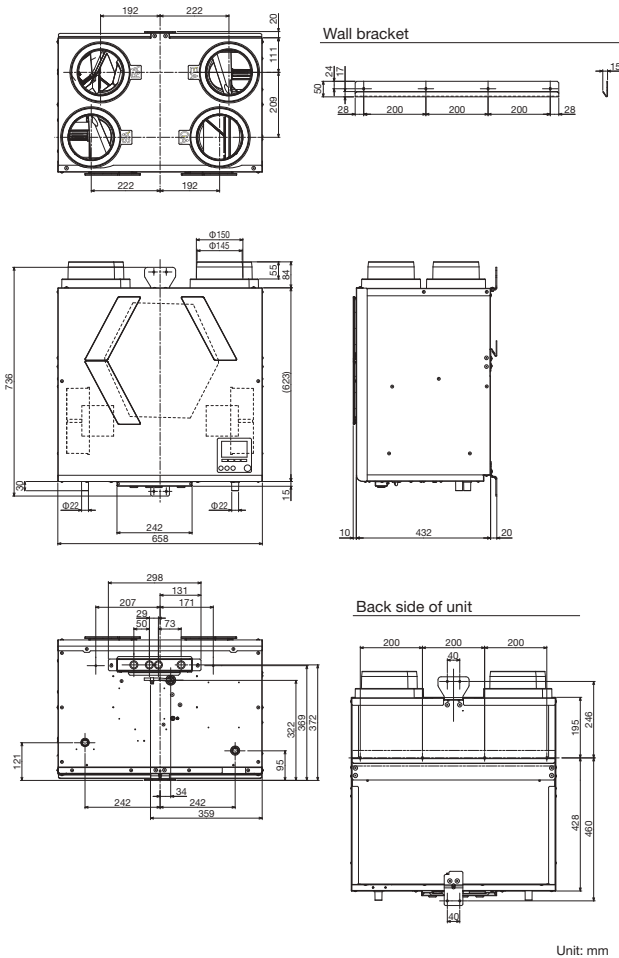

VL-350CZPVU-L-E

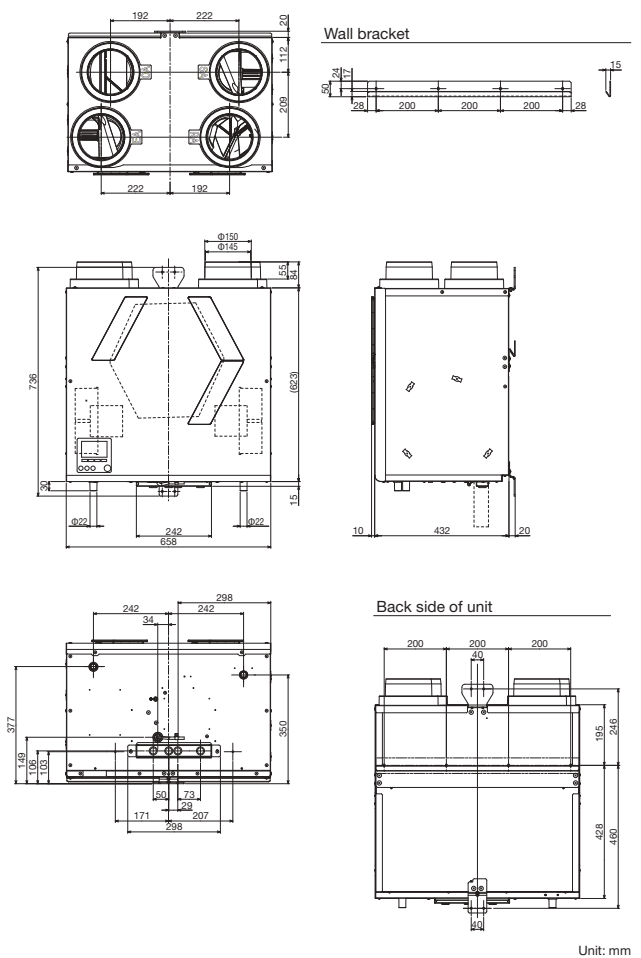

VL-500CZPVU-R/L-E

Electrical Power Supply	220-240V/50Hz, 220V/60Hz				
Ventilation Mode	Heat recovery mode				
Fan Speed	FS4 (100%)	FS3 (70%)	FS2 (50%)	FS1 (30%)	
Running Current (A)	1.73	0.77	0.40	0.19	
Input Power (W)	275	104	49	21	
Airflow	(m³/h)	500	350	250	150
	(L/s)	139	97	69	42
External Static Pressure (Pa)	200	98	50	18	
Temperature Exchange Efficiency (%)	85	87	89	92	
Noise Level (dB)	37	29	22	15>	
Energy Efficiency Class	A+				
Weight (kg)	39				
Dimensions (mm)	(H) 632 x (W) 725 x (D) 556				

Attention

1. The above values are at factory default.
2. The running current, the input power, the efficiency and the noise are based on the rating airflow, and 230V/50Hz.
3. The sound pressure level at 3m is spherical.
4. Temperature exchange efficiency (%) is based on winter condition.
5. Mitsubishi Electric measures figures in the chart according to EN13141-7: 2010, and the characteristic curves are measured by chamber method.

Characteristic Curves

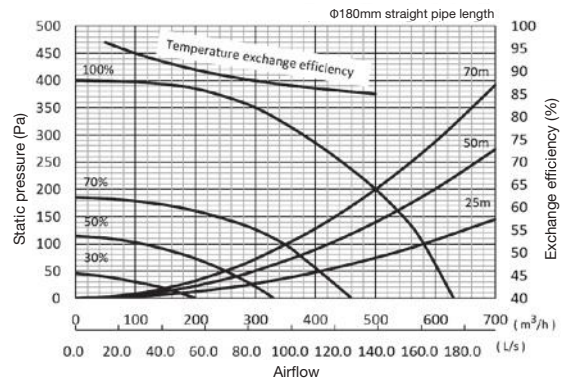

Attention

Mitsubishi Electric measures figures in the chart according to EN13141-7: 2010, and the characteristic curves are measured by chamber method.

Dimensions

VL-500CZPVU-R-E

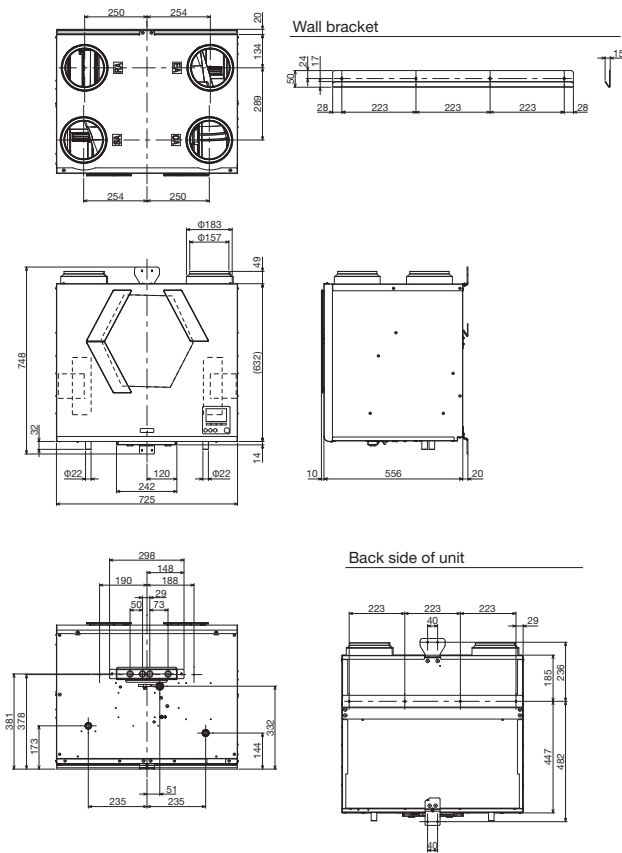





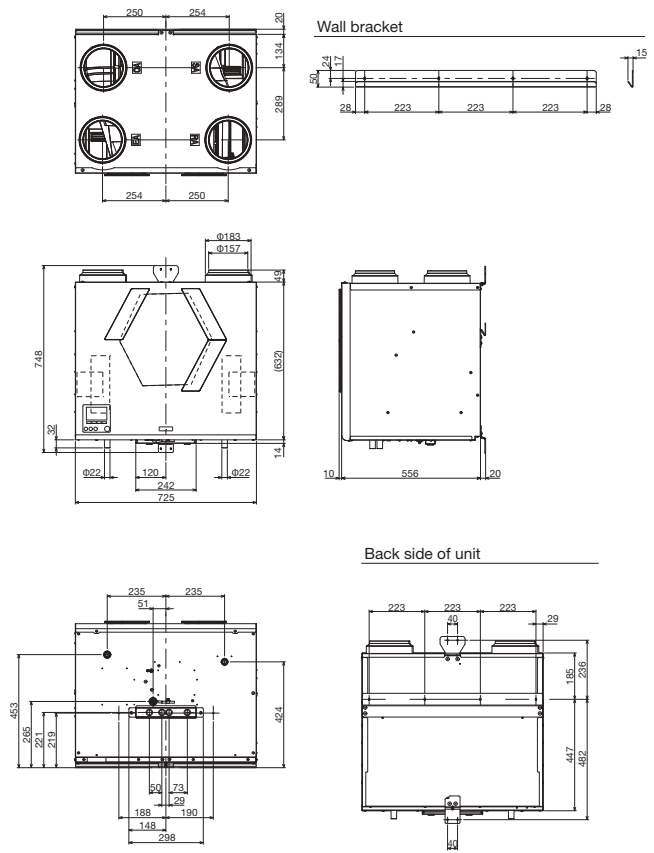

Unit: mm

VL-500CZPVU-L-E

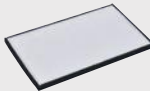

Unit: mm

Filters

Type	Replacement Filter	Standard Filter	Medium Efficiency Filter	Advanced Efficiency Filter	Advanced High Efficiency Filter	NOx Filter
						
Model	P-250F-E P-350F-E P-500F-E	P-250SF-E P-350SF-E P-500SF-E	P-250MF-E P-350MF-E P-500MF-E	P-250PF-E P-350PF-E P-500PF-E	P-250PFH-E P-350PFH-E P-500PFH-E	P-250NF-E P-350NF-E P-500NF-E
Classification	EN779 (2012)	G3	G4	M6	M6	
	ISO 16890 (2016)	Coarse 55%	Coarse 90%	ePM ₁₀ 80%	ePM _{2.5} 50%	ePM ₁ 55%

Pressure loss characteristics

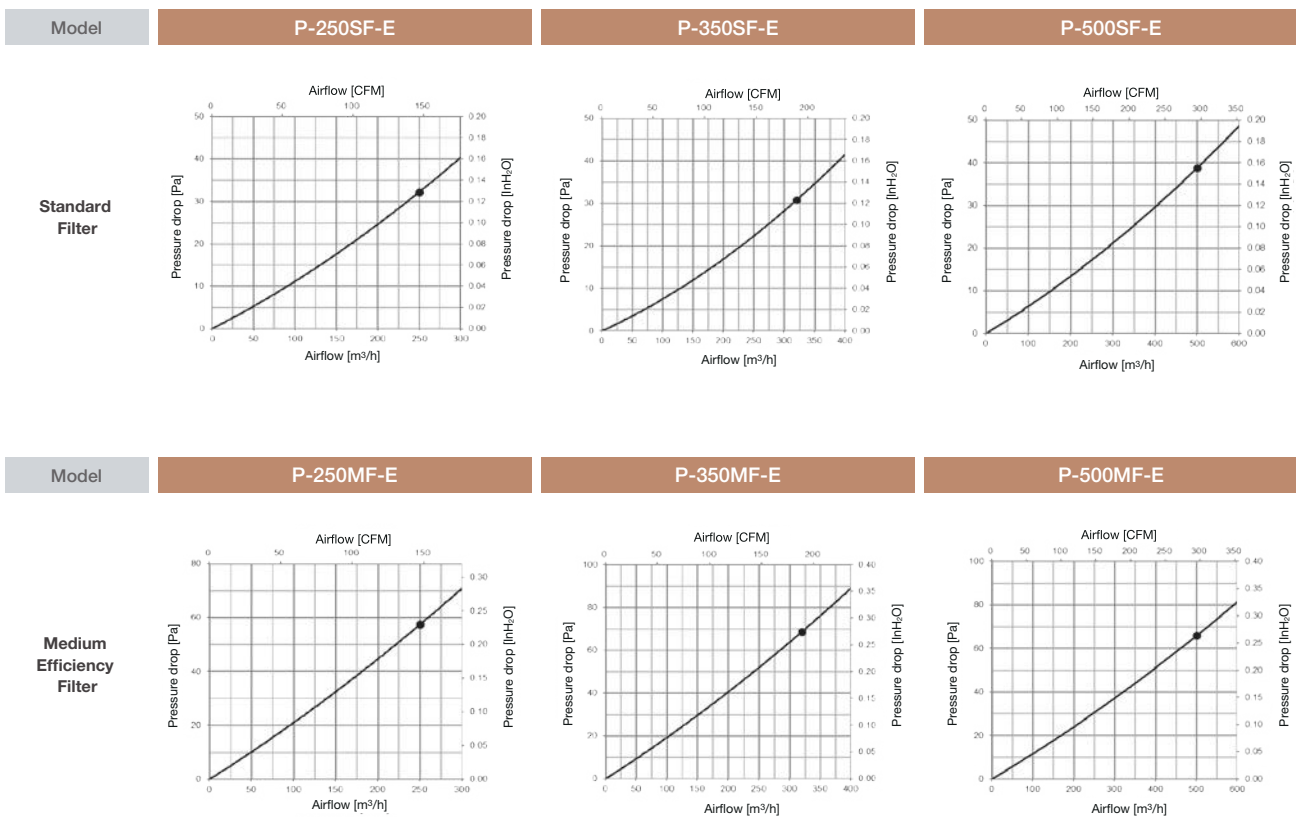

Pressure loss characteristics

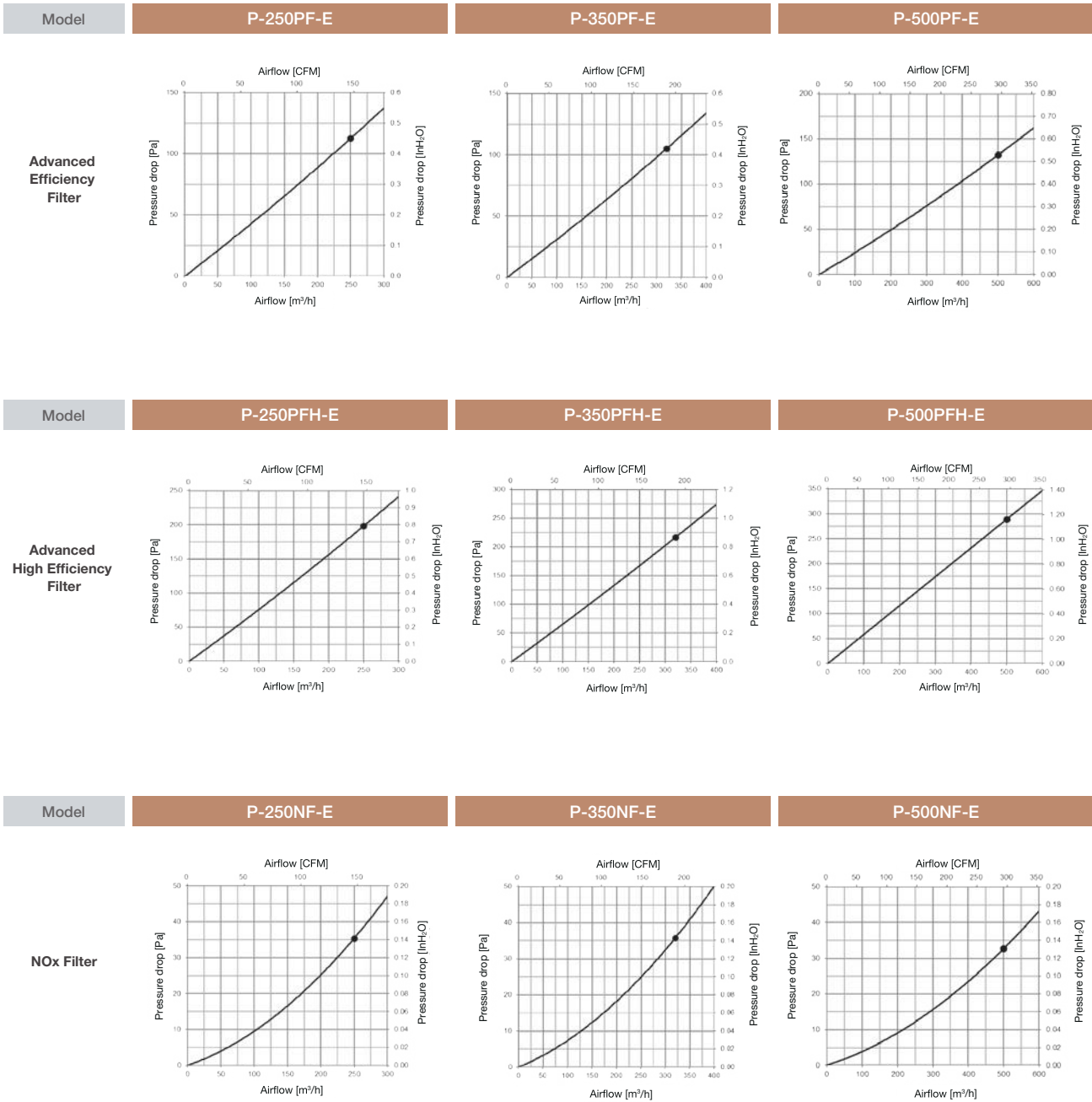

Silencer Box

P-250/350/500SB-E

Noise level can be further decreased by using a silencer box.

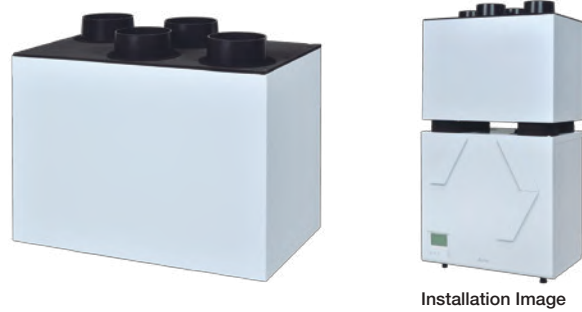

Installation Image

Model

P-250SB-E

Attenuation of sound power level for center frequency

Airflow (m ³ /h)	Static pressure (Pa)	Point	Attenuation of sound power level for center frequency Hz (dB)							
			63	125	250	500	1000	2000	4000	8000
175	74	Outlet (SA/EA)	9	7	11	19	29	28	21	13

- Figures in the chart above are measured by Mitsubishi Electric.
- The silencer box is placed just after the outlet of the LOSSNAY unit as specified in the Installation Manual.
- When airflow differs, attenuation may also differ from the chart above.

Pressure loss curve

The curve on the right shows the total pressure drop of the OA and SA or RA and EA ducts in the silencer box.

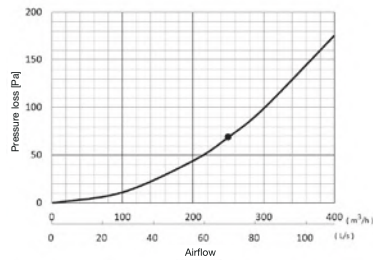

Dimensions

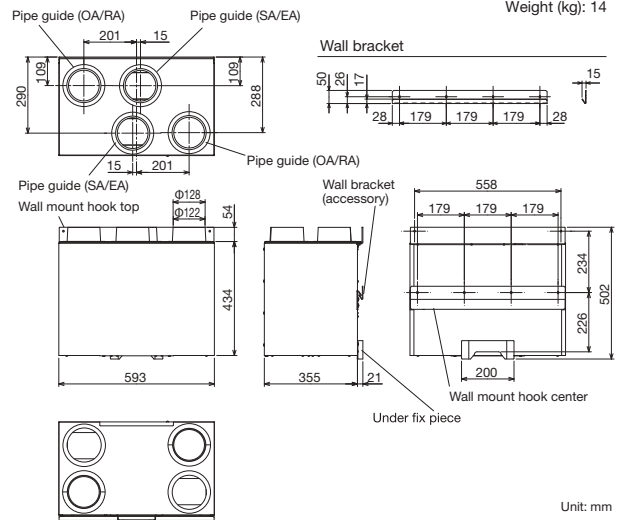

Model

P-350SB-E

Attenuation of sound power level for center frequency

Airflow (m ³ /h)	Static pressure (Pa)	Point	Attenuation of sound power level for center frequency Hz (dB)							
			63	125	250	500	1000	2000	4000	8000
224	74	Outlet (SA/EA)	12	8	11	21	32	29	19	12

- Figures in the chart above are measured by Mitsubishi Electric.
- The silencer box is placed just after the outlet of the LOSSNAY unit as specified in the Installation Manual.
- When airflow differs, attenuation may also differ from the chart above.

Pressure loss curve

The curve on the right shows the total pressure drop of the OA and SA or RA and EA ducts in the silencer box.

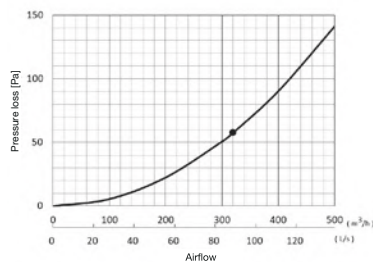

Dimensions

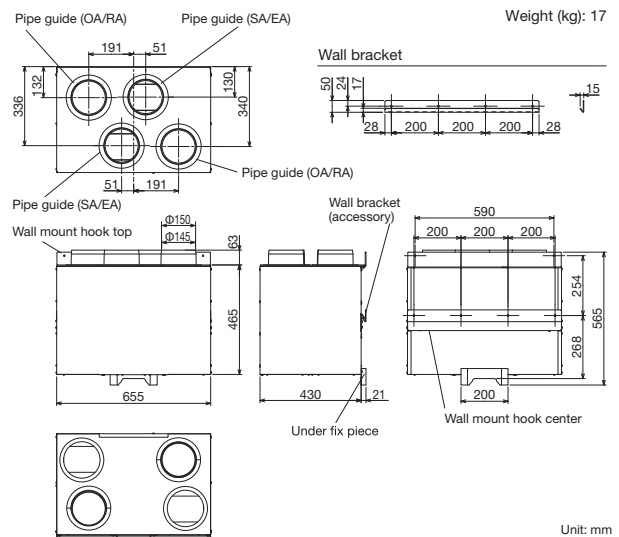

Model

P-500SB-E

■ Attenuation of sound power level for center frequency

Airflow (m ³ /h)	Static pressure (Pa)	Point	Attenuation of sound power level for center frequency Hz (dB)							
			63	125	250	500	1000	2000	4000	8000
350	98	Outlet (SA/EA)	10.5	9.5	13.0	21.0	27.0	29.0	26.0	14.0

- Figures on the chart above are measured by Mitsubishi Electric.
- The silencer box is placed on the just after the outlet of the LOSSNAY unit as specified in the Installation Manual.
- When the airflow differs, the attenuation may be also different from the chart above.

■ Pressure loss curve

The curve on the right shows the total pressure drop of the OA and SA or RA and EA ducts in the silencer box.

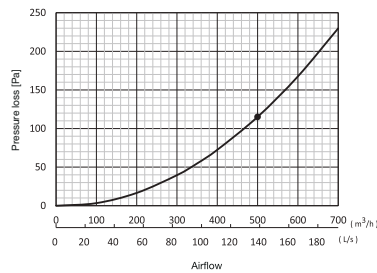

■ Dimensions

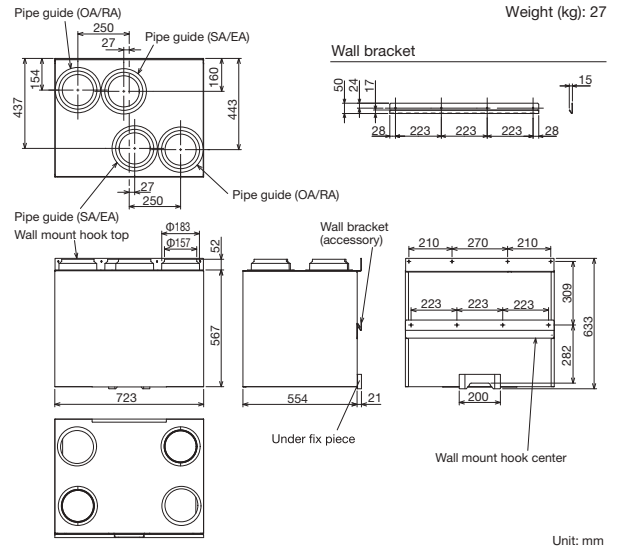

Remote Controller Cover

P-RCC-E

By attaching a Remote Controller Cover, the remote controller can be installed at a distance from the unit.

■ Dimensions

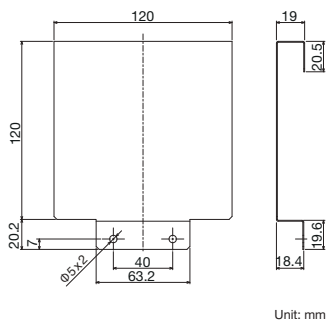

■ Configuration

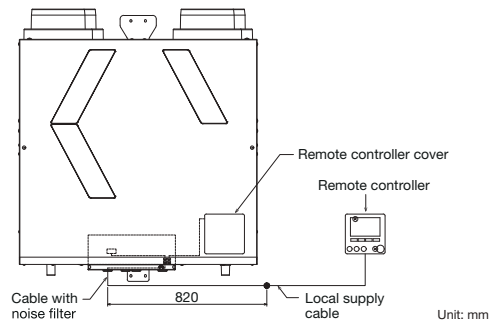

Remote Controller Cover



Cable with Noise Filter
(Cable length outside the product: Approximately 820 mm)

VL-50(E)S₂-E, VL-50SR₂-E VL-100(E)U₅-E

Wall mounted models. Particularly suitable for houses and small offices.



VL-50(E)S₂-E
VL-50SR₂-E



VL-100(E)U₅-E

Decentralized ventilation: VL-50(E)S₂-E, VL-50SR₂-E and VL-100(E)U₅-E

Product advantages

Air supplied and Exhausted Simultaneously

Air is supplied and exhausted simultaneously while transferring the heat.

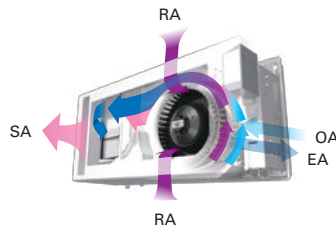

Energy Efficient

- Total heat exchange minimizes heat loss.
- Achieve over 80%* temperature efficiency.

*VL-100(E)U₅-E at low fan speed in 230V 50Hz
*VL-50(E)S₂-E at low fan speed in 230V 50Hz

Low noise levels are ideal for bedrooms and children's rooms.

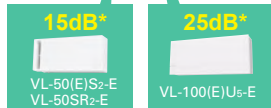
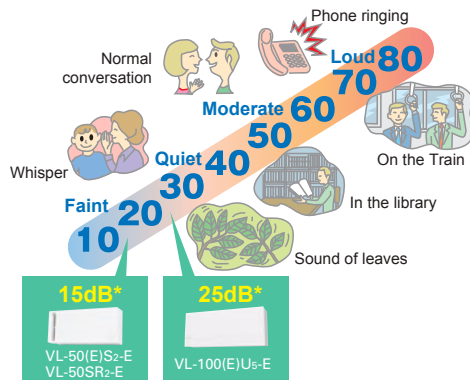

*Condition: 50Hz, 230V, low fan speed

Sound Insulation

A sound insulation effect reduces the level of noise generated outside.

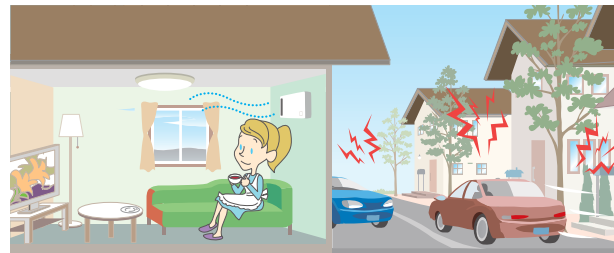

Sound Insulation Effect	Sound Source Side Average sound pressure dB	Sound Receiving Side Average sound pressure dB	Difference
	103.4	63.2	40.2

*Tested based on VL-08S₂-AE

*Measured by average sound pressure level of more than 30dB in 500Hz according to JIS A1416.

VL-08S₂-AE is a Japanese dedicated model equivalent to VL-50(E)S₂-E

Easy Maintenance

The only maintenance required is cleaning the outside-air filter and exhaust-air filter. Filters are easily accessible, making quick and thorough cleaning possible.

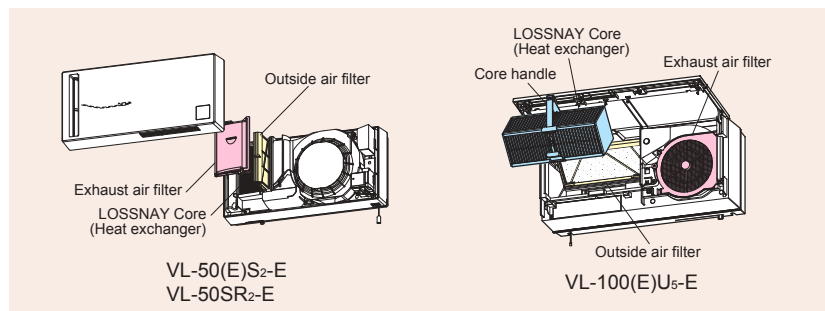

Flexible Installation for Only VL-50(E)S₂-E and VL-50SR₂-E

Both horizontal and vertical installations are possible to fit various types of rooms.

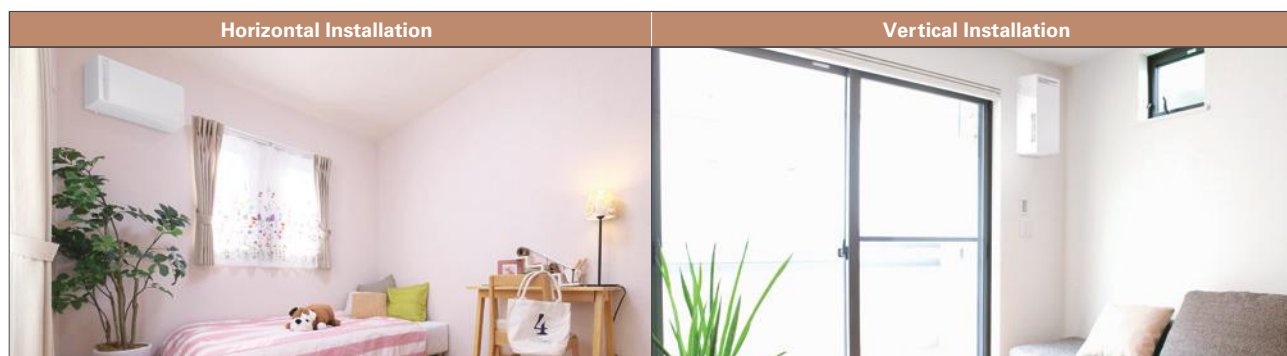

Model: VL-100U₅-E (Pull-Switch Model) and VL-100EU₅-E (Wall-Switch Model)

Model	VL-100(E)U ₅ -E							
	220V/50Hz		230V/50Hz		240V/50Hz		220V/60Hz	
Electrical power supply	220V/50Hz		230V/50Hz		240V/50Hz		220V/60Hz	
Fan speed	High	Low	High	Low	High	Low	High	Low
Airflow (m ³ /h)	100	55	105	60	106	61	103	57
Power consumption (W)	30	13	31	15	34	17	34	17
Temperature exchange efficiency (%)	73	80	73	80	72	79	73	80
Noise level (dB)	36.5	24	37	25	38	27	38	25
Weight (kg)	7.5							
Specific energy consumption class	B							

*Figures in the chart were measured according to Japan Industrial Standard (JIS B 8628) with the shutter knob in open position.

Dimensions

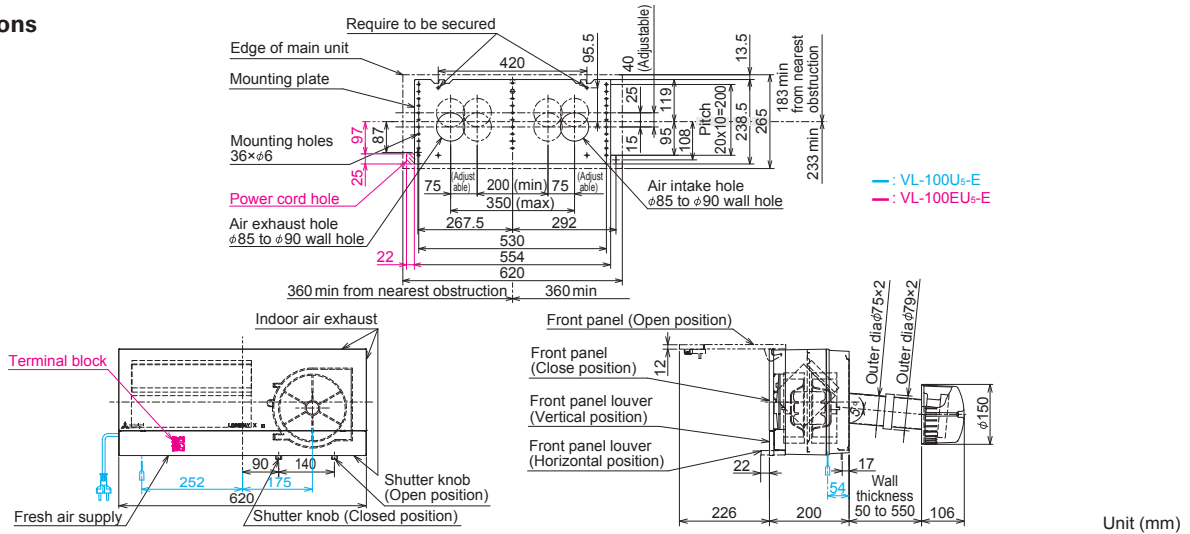

Optional Parts

Optional Parts for VL-50(E)S₂-E and VL-50SR₂-E

Filter, Extension Pipe and Stainless Hood

Type	Replacement Filter	High Efficiency Filter	Extension Pipe	Joint	Stainless Hood
Design					
Model	P-50F ₂ -E	P-50HF ₂ -E	P-50P-E	P-50PJ-E	P-50VQS ₅ -E
Feature	-	-	Total length when connected to the joint is 350mm.	Joint for extension pipe	Stylish stainless hood
Classification (EN779:2012)	G3	-	-	-	-
Classification (ISO16890)	Coarse 35%	ePM ₁₀ 75%	-	-	-

Optional Parts for VL-100(E)U₅-E

Filter and Extension Pipe

Type	Replacement Filter	High Efficiency Filter	Extension Pipe	Joint
Design				
Model	P-100F ₅ -E	P-100HF ₅ -E	P-100P-E	P-100PJ-E
Feature	-	-	Total length when connected to the joint is 300mm.	• Joint for extension pipe • Screw-in method
Classification (EN779:2012)	G3	M6	-	-
Classification (ISO16890)	Coarse 35%	ePM ₁₀ 70%	-	-

PLASMA QUAD PROTECT

Features and Concepts

Reliable purification performance

JC-23KR-EU is equipped with a glass fiber HEPA filter rated as an EN1822 H13 grade filter. This product has a CADR (Clean Air Delivery Rate) value of 254m³/h (Pollen), 222m³/h (Dust) and 238m³/h (Smoke).



Tests report results

Suppresses viruses

Test result of operating the unit with an air volume of 230m³/h in a 25m³ closed space: 99% suppression in 25 minutes. This result does not represent the product's performance in a practical operating environment.

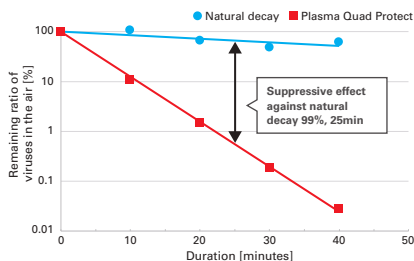

[Testing laboratory] Kitasato Research Center for Environmental Science
 [Testing method] Spraying virus in 25m³ of closed space, collecting the air in the space after a certain period of time, and measuring the amount of virus in the air.
 [Condition] Operating JC-23KR-EU with an air volume of 230m³/h, 1 type of virus
 [Result] 99% suppression after 25min.
 Test Report No.2022_0421

Suppresses bacteria

Test result of operating the unit with an air volume of 230m³/h in a 25m³ closed space: 99% suppression in 28 minutes. This result does not represent the product's performance in a practical operating environment.

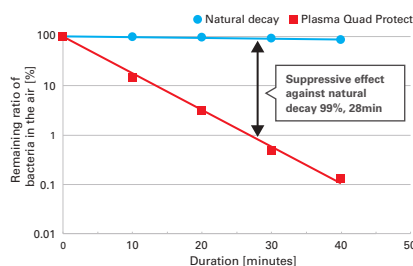

[Testing laboratory] Kitasato Research Center for Environmental Science
 [Testing method] Spraying bacteria in 25m³ of closed space, collecting the air in the space after a certain period of time, and measuring the amount of bacteria in the air.
 [Condition] Operating JC-23KR-EU with an air volume of 230m³/h, 1 type of bacteria
 [Result] 99% suppression after 28min.
 Test Report No.2022_0420

Removes 99% PM2.5

Test result of operating the unit with an air volume of 230m³/h in a 27.5m³ closed space: 99% suppression in 31 minutes. PM2.5 is a general term for fine particulate matter of 2.5µm or less.

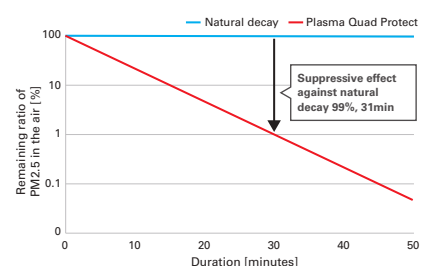

[Testing method] According to JEM1467. Operating JC-23KR-EU (230m³/h, 31min.) in a closed space of 27.5m³. Additional particle from outside is not considered. This result does not represent the product's performance in an actual operating environment.

Easy, space-saving installation

Quick and easy installation, space-saving and design that compliments any interior.

- 1 Attach the mounting plate to the wall by screwing in 4 points.

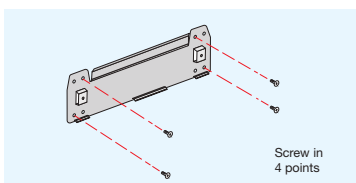

- 2 Hook the unit onto the mounting plate.

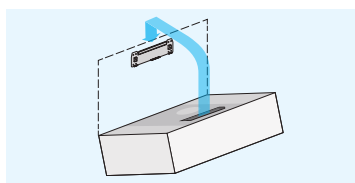

- 3 Screw in 2 points to secure the unit to the mounting plate.

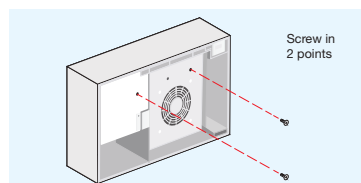

With a depth of just 175mm, the unit can be installed on the wall and save floor space in the room. Its simple appearance matches any wall color or furniture.

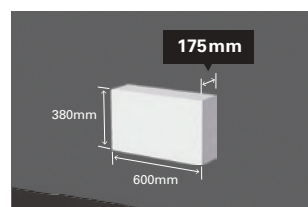

New MELCO package solution

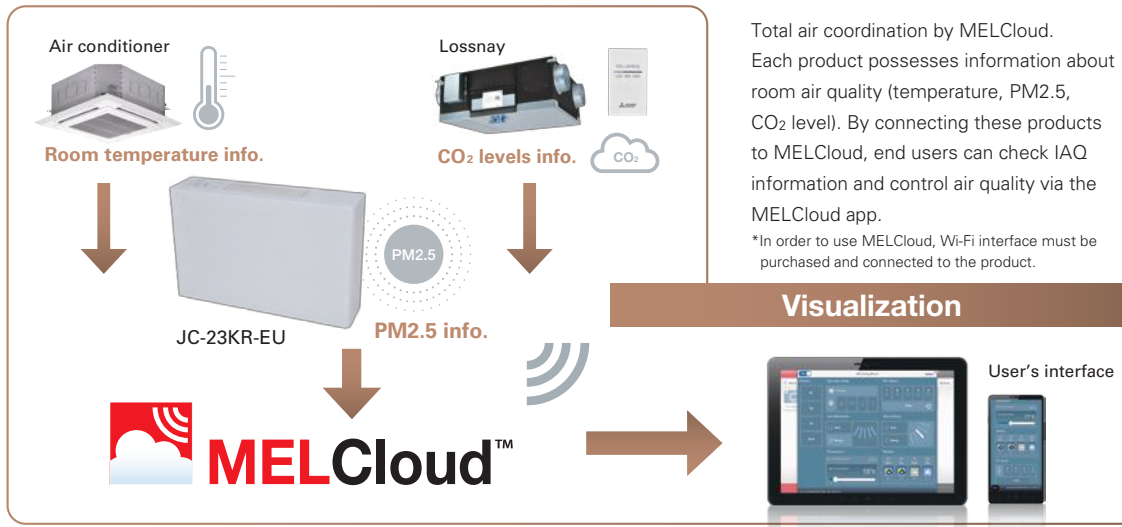

Specifications

Model	Voltage	Fan speed	Power consumption [W]	Air volume [m ³ /h]	Noise level [dB]	Weight [kg]
JC-23KR-EU	220V	Silent	8	20	34	8.5
		Powerful	63.5	230	72	
	230V	Silent	8	20	34	
		Powerful	63.5	230	72	
	240V	Silent	8	20	34	
		Powerful	63.5	230	72	

JC-23KR-EU has an Auto mode.

This product adjusts air volume according to the quantity of dust detected by the dust sensor.

Dimensions

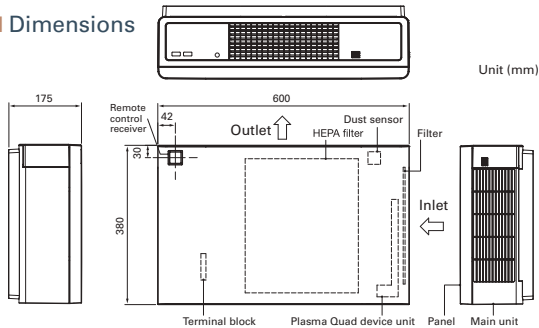

Replacement HEPA filter



P-23KHF-E

Small air volume type

JC-4K-EU



- Plasma Quad device
- Dual Barrier Coating
- Low noise operation and energy efficiency
- Installed to ceiling and wall

Dimensions

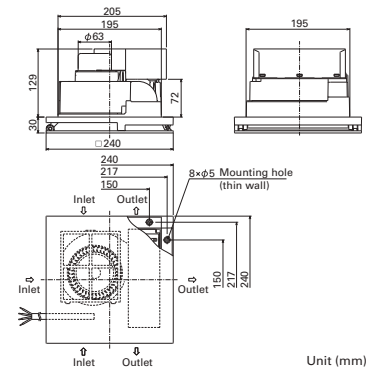

Specifications

Model	Voltage	Fan speed	Power consumption [W]	Air volume [m ³ /h]	Noise level [dB]	Weight [kg]
JC-4K-EU	220V	High	11.5	38	35	2.4
		Low	7.5	19	20	
	230V	High	12.5	40	36.5	
		Low	8	20	21	
	240V	High	13.5	42	38.5	
		Low	8.5	21	22	

Optional parts list

Optional Parts		LOSSNAY																		
		LGH-15RVX3-E	LGH-25RVX3-E	LGH-35RVX3-E	LGH-50RVX3-E	LGH-65RVX3-E	LGH-80RVX3-E	LGH-100RVX3-E	LGH-160RVX3-E	LGH-200RVX3-E	LGH-150RVXT-E	LGH-200RVXT-E	LGH-250RVXT-E	GUF-50RD4	GUF-50RDH4	GUF-100RD4	GUF-100RDH4	LGH-50RVS-E	LGH-80RVS-E	LGH-100RVS-E
LOSSNAY Remote Controller	PZ-62DR-EA/EB	●	●	●	●	●	●	●	●	●	●	●	●					●	●	●
	PZ-43SMF-E	●	●	●	●	●	●	●	●	●	●	●	●					●	●	●
Standard Filter (Coarse 60%)	PZ-15RF3-E	●																		
	PZ-25RF3-E		●																	
	PZ-35RF3-E			●																
	PZ-50RF3-E				●															
	PZ-65RF3-E					●														
	PZ-80RF3-E						●				●									
	PZ-100RF3-E							●				●								
ePM1 75% Filters	PZ-15RFP3-E	●																		
	PZ-25RFP3-E		●																	
	PZ-35RFP3-E			●																
	PZ-50RFP3-E				●															
	PZ-65RFP3-E					●														
	PZ-80RFP3-E						●			●										
	PZ-100RFP3-E							●			●									
M6 Filters	PZ-15RFM3-E	●																		
	PZ-25RFM3-E		●																	
	PZ-35RFM3-E			●																
	PZ-50RFM3-E				●															
	PZ-65RFM3-E					●														
	PZ-80RFM3-E						●			●										
	PZ-100RFM3-E							●			●									
F8 Filters	PZ-15RFH3-E	●																		
	PZ-25RFH3-E		●																	
	PZ-35RFH3-E			●																
	PZ-50RFH3-E				●															
	PZ-65RFH3-E					●														
	PZ-80RFH3-E						●			●										
	PZ-100RFH3-E							●			●									
Standard Filters	PZ-50RF8-E												●	●						
	PZ-100RF8-E													●	●					
	PZ-150RTF-E										●									
	PZ-250RTF-E											●	●							
	PZ-S50RF-E																		●	
	PZ-S80RF-E																		●	
	PZ-S100RF-E																			●
High-efficiency Filters	PZ-50RFM-E												●	●						
	PZ-100RFM-E													●	●					
	PZ-S50RFM-E																		●	
	PZ-S80RFM-E																		●	
	PZ-S100RFM-E																			●
Advanced High-efficiency Filters	PZ-50RFP2-E												●	●						
	PZ-100RFP2-E													●	●					
	PZ-M6RTFM-E										●	●	●							
	PZ-F8RTFM-E										●	●	●							
	PZ-S50RFH-E																		●	
	PZ-S80RFH-E																		●	
Duct Silencer	PZ-100SS-E	●																		
	PZ-150SS-E		●	●																
	PZ-200SS-E				●	●								●	●					
	PZ-250SS-E						●	●	●	●						●	●		●	●
CO ₂ Sensor	PZ-70CSD-E	●	●	●	●	●	●	●	●	●								●	●	●
	PZ-70CSW-E	●	●	●	●	●	●	●	●	●								●	●	●
Vertical installation parts	PZ-1VS-E	●	●	●	●															
	PZ-2VS-E				●	●	●													
Signal output terminal	PZ-4GS-E	●	●	●	●	●	●	●	●									●	●	●

Note: Please refer to each product page for required number of pieces/sets.

List of optional parts for the VL-CZPVU Series

Optional Parts					LOSSNAY	VL-250CZPVU-R/L-E	VL-350CZPVU-R/L-E	VL-500CZPVU-R/L-E
Filter	Type	Classification (EN779:2012)	Classification (ISO16890)	Model				
	Replacement Filter	G3		Coarse 55%	P-250F-E	●		
P-350F-E						●		
P-500F-E							●	
Standard Filter	G4		Coarse 90%	P-250SF-E	●			
				P-350SF-E		●		
				P-500SF-E			●	
Medium Efficiency Filter	M6		ePM ₁₀ 80%	P-250MF-E	●			
				P-350MF-E		●		
				P-500MF-E			●	
Advanced Efficiency Filter	M6		ePM _{2.5} 50%	P-250PF-E	●			
				P-350PF-E		●		
				P-500PF-E			●	
Advanced High Efficiency Filter			ePM ₁ 55%	P-250PFH-E	●			
				P-350PFH-E		●		
				P-500PFH-E			●	
NoxFILTER			NO ₂ 90%	P-250NF-E	●			
				P-350NF-E		●		
				P-500NF-E			●	
Silencer Box				P-250SB-E	●			
				P-350SB-E		●		
				P-500SB-E			●	
Remote Controller Cover				P-RCC-E	●	●	●	

List of optional parts for the VL-50/100 Series

Optional Parts					LOSSNAY	VL-50S ₂ -E	VL-50ES ₂ -E	VL-50SR ₂ -E	VL-100U ₅ -E	VL-100EU ₅ -E
Filter	Type	Classification (EN779:2012)	Classification (ISO16890)	Model						
	Replacement Filter	G3		Coarse 35%	P-50F ₂ -E	●	●	●		
P-100F ₅ -E								●	●	
High Efficiency Filter	M6		ePM ₁₀ 75%	P-50HF ₂ -E	●	●	●			
				P-100HF ₅ -E				●	●	
Extension Pipe				P-50P-E	●	●	●			
				P-100P-E				●	●	
Joint				P-50PJ-E	●	●	●			
				P-100PJ-E				●	●	
Stainless Hood				P-50VSQ ₅ -E	●	●	●			

 **NOTICE**

Our air-conditioning equipments and heat pumps contain a fluorinated greenhouse gas, R410A (GWP: 2088) or R32 (GWP: 675). *These GWP values are based on Regulation (EU) No.517/2014 from IPCC 4th edition. In case of Regulation (EU) No.626/2011 from IPCC 3rd edition, these are as follows. R410A (GWP: 1975), R32 (GWP: 550)

 **CAUTION**

Do not install indoor units in areas (e.g. mobile phone base stations) where the emission of VOCs such as phthalate compounds and formaldehyde is known to be high as this may result in a chemical reaction.

 **WARNING**

When installing or relocating or servicing our air-conditioning equipment, use only the specified refrigerant (R410A or R32) to charge the refrigerant lines.

Do not mix it with any other refrigerant and do not allow air to remain in the lines.

If air is mixed with the refrigerant, then it can be the cause of abnormal high pressure in the refrigerant lines, and may result in an explosion and other hazards.

The use of any refrigerant other than that specified for the system will cause mechanical failure, system malfunction or unit breakdown. In the worst case, this could lead to a serious impediment to securing product safety.

MITSUBISHI ELECTRIC CORPORATION

HEAD OFFICE: TOKYO BUILDING, 2-7-3 MARUNOUCHI, CHIYODA-KU, TOKYO 100-8310, JAPAN
<https://www.mitsubishielectric.com/>

Air Conditioner Catalogue
E-2306259 (18050)



E-2306259



Revised publication effective Apr. 2023.
Superseding publication of S-179-2-CA762-A Jan. 2022.
Specifications are subject to change without notice.